



ΘΕΟΔΩΡΙΔΗΣ ΙΩΑΝΝΗΣ & ΥΙΟΣ Ο.Ε.





Η Εταιρία ΘΕΟΔΩΡΙΔΗΣ ΙΩΑΝΝΗΣ & ΥΙΟΣ ΟΕ εδρεύει στην Θεσσαλονίκη, και δραστηριοποιείται με επιτυχία στον τομέα των βιομηχανικών - ανοξείδωτων ειδών.  
 Ιδρύθηκε το 1977 από τον ΘΕΟΔΩΡΙΔΗ ΙΩΑΝΝΗ και από τότε με συνεχή ανοδική πορεία, παρέχει υποστήριξη σε επαγγελματίες και ερασιτέχνες στις ανάγκες τους σε βίδες, εργαλεία και συναφή είδη.  
 Η εταιρία είναι σε θέση να καλύπτει τις ανάγκες των πελατών της σε μεγάλη ποικιλία προϊόντων με αξιοπιστία και εμπιστοσύνη.

### Τραπεζικοί λογαριασμοί

#### **Eurobank:**

Όψεως: 0026 0216 9502 0041 3792

IBAN: GR66 0260 2160 0009 5020 0413 792

#### **Πειραιώς:**

Όψεως: 5223-074887-080

IBAN: GR93 0172 2230 0052 2307 4887 080

#### **Εθνική:**

Όψεως: 236/440409-27

IBAN: GR65 0110 2360 0000 2364 4040 927



Στοχεύστε για να δείτε διαδρομή μέσω Google maps



**Ρούχα εργασίας**

- 13. Παπούτσια
  - 16. Αξεσουάρ υπόδυσης
  - 17. Παντελόνια
  - 19. Μπουφάν
  - 21. Φλις - Εσωθερμικά
  - 22. Γυαλιά - Μάσκες
  - 23. Μάσκες - Ωτασπίδες
  - 24. Προστασία πτώσης
  - 25. Κράνη - Επιγονατίδες
  - 26. Γάντια
- Εργαλεία**
- 27. Θήκες εργαλείων - Εργαλειοθήκες
  - 35. Κολλητήρια - Καλάι
  - 38. Φλόγιστρα
  - 40. Οξυγονοκολλήσεις
  - 41. Ανταλλακτικά οξυγονοκολλήσεων
  - 43. Γκαζάκια - Αναπτήρες
  - 44. Σχοινιά - Ιμάντες
  - 45. Φακοί
  - 46. Σετ ξυλογλυπτικής - Ακονόπετρες
  - 47. Κατσαβίδια
  - 52. Ταφ
  - 53. Σημαδευτήρια - Προκοβγάτες
  - 54. Μύτες κατσαβιδιών
  - 59. Πένσες
  - 60. Πένσες ασφαλειών
  - 63. Μυτοσίμπιδα - Τσιμπίδες
  - 65. Κοφτάκια
  - 67. Εμπροσθοκόφτες - Απογυμνωτές
  - 70. Πρέσες βυσμάτων
  - 71. Κλειδιά φίλτρου
  - 72. Πένσες κολιέδων
  - 73. Γκαζοτανάλιες - Τσιμπίδες
  - 74. Ψαλίδια - Ταπόνια - Γκριπ
  - 75. Γερμανικά - Γαλλικά - Γαντζόκλειδα
  - 76. Γερμανοπολύγωνα κλειδιά
  - 77. Πολύγωνα κλειδιά
  - 78. Πίπες - Ταπόκλειδα - κλειδιά πείρου
  - 79. Σετ κλειδιά
  - 80. Κλειδιά allen
  - 83. Κλειδιά torx - polydrive - XZN
  - 84. Σετ καρυδάκια
  - 88. Σετ καρυδάκια - Σετ εργαλεία
  - 89. Σετ καρυδάκια χωρίς κασάνια
  - 90. Κασάνιες
  - 91. Προεκτάσεις - Μανέλες
  - 92. Κατσαβίδια για καρυδάκια - Αντάπτορες - Σπαστά
  - 93. Καρυδάκια
  - 99. Αερόκλειδα - Αεροκασάνιες
  - 100. Καρυδάκια αερόκλειδου
  - 104. Διαμαντοτρύπανα
  - 107. Ποτηροκορώνες
  - 108. Τρυπάνια αέρος
  - 111. Ζουμπάδες - Κεντραδόροι χειρός
  - 112. Τρυπάνια γυαλιού - ξύλου
  - 113. Σετ τρυπάνια
  - 114. Φρεζάκια
  - 115. Βύσματα ξύλου - Στηρίγματα σωλήνα



































































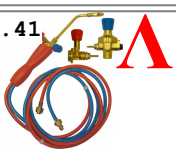

- 115. Τσέρκια - Βύσματα τοίχου - γυψοσανίδας
- 119. Γάντζοι - Θηλιές - Κρίκοι - Στριφωνόβιδες
- 120. Μεταλλικά βύσματα - Αγκύρια
- 122. Στριφώνια - Μπετονόβιδες
- 123. Τζαμοκόφτες - Βεντούζες - Καρφωτικά - Πιάτα
- 124. Χωνιά - Κανάτες - Μπιτόνια - Pressol
- 125. Ταινίες συσκευασίας - φιλμ
- 126. Πιστόλια θερμαινόμενης σιλικόνης
- 127. Φαλτσέτες
- 128. Ανταλλακτικές λεπίδες
- 129. Ανταλλακτικές λεπίδες σέγας
- 132. Ανταλλακτικές λεπίδες σπαθοσέγας
- 134. Ψαλίδια
- 135. Ψαλίδια λαμαρίνας
- 136. Πριόνια χειρός
- 137. Πριονοκορδέλες
- 139. Διαμαντόδισκοι - Δίσκοι κοπής ξύλου
- 140. Δίσκοι κοπής μετάλλων
- 141. Κοπτικά τρύπας - Ποτηροκορώνες - Ποτηροτρύπανα
- 142. Κώνικες φρέζες - Κεντραδόροι
- 143. Βελόνια - Καλέμια - Κοπίδια SDS
- 144. Μαχαίρια τόννου
- 145. Κονδύλια
- 146. Βοηθητικά εργαλεία
- 147. Λειαντικά δραπεάνου
- 148. Αλοιφές κοπτικών - Σπρέι
- 149. Σπρέι - Γράσα
- 151. Κόλλες
- 152. Κόλλες - Καθαριστικά
- 153. Σπρέι - Αλοιφές γυαλισματος
- 154. Σπρέι χρώμα
- 156. Μετροταινίες
- 157. Μεζούρες - Ρίγες - Γωνίες
- 158. Παχύμετρα - Μικρόμετρα
- 159. Φίλλερ - Σπειρόμετρα - Κουμπάσα
- 160. Εξολκεία
- 170. Κρουστικά κατσαβίδια
- 171. Περτσιναδόροι - Περτσίνια
- 172. Περτσίνια - Κεντραδόροι
- 173. Χτυπητά γράμματα - Στένσιλ
- 174. Φλαντζοκόφτες - Σγρόπιες
- 175. Κολαούζα
- 179. Φιλιέρες
- 181. Μανέλες κολαούζων - φιλιέρας
- 182. Ελατήρια επιδιόρθωσης πάσων
- 183. Κιτ πάσων - Κώνοι - Φωλιές
- 184. Τσοκ
- 185. Δυναμόκλειδα
- 188. Σφιγκτήρες μαραγκών
- 190. Μόρσες - Σαπόρτ - Αμόνια
- 192. Συρματόβουρτσες
- 186. Λίμες - Γυαλιά ηλεκτροκόλλησης
- 196. Λίμες - Γυαλιά ηλεκτροκόλλησης
- 197. Ανταλλακτικά ηλεκτροκόλλησης
- 198. Λουκέτα
- 199. Λουκέτα - Κλειδαριές - Κύλινδροι
- 200. Κύλινδροι - Κυπριά - Σούστες πόρτας
- 201. Σφυριά - Βαριοπούλες - Ματσόλες
- 202. Σκύλες - Κοπίδια - Βελόνια
- 203. Φτυάρια - Μυστηριά - Μακαράδες - Κουβάδες

- 204. Πιστόλια σιλικόνης - αφρού - Μίξερ - Κουβάδες
  - 205. Εργαλεία γυψοσανίδας
  - 206. Εργαλεία γυψοσανίδας - Σπάτουλες
  - 207. Σπάτουλες - Ξύστρες - Αλφάδια
  - 208. Αλφάδια
  - 209. Γρασαδοράκια
  - 210. Γρασαδόροι
  - 211. Σφήνες - Τραπεζοειδείς ντίζες
  - 212. Πόμολα με αρσενικό πάσο
  - 213. Πόμολα με θηλυκό πάσο - Λεβιέδες κασάνιες
  - 214. Βολάν - Χειρολαβές - Μεντεσέδες νάυλον - Σφαιρικά πόμολα - Τάπες
  - 215. Πέλματα βάσεις
  - 216. Τάπες - Μαγνήτες νεοδιμίου - Τρυπανόβιδες
  - 217. Βίδες γαλβανιζέ
- Ανοξείδωτα**
- 218. Βιδωτά κολάρα ανοξείδωτα
  - 219. Εξάγωνες βίδες
  - 220. Περικόχλια
  - 221. Ροδέλες
  - 222. Μηχανόβιδες - Κασονόβιδες
  - 225. Βύσματα
  - 226. Αλενόβιδες
  - 228. Νοβοπανόβιδες - Στριφώνια
  - 229. Λαμαρινόβιδες - Τρυπανόβιδες
  - 230. Ασφάλειες - Κοπίλιες - Σφήνες
  - 231. Ασφάλειες - Μποζόνια - Καβίλιες
  - 232. Περόνες - Πίροι - Γάντζοι S - Δέλτα
  - 233. Κρίκοι - Περτσίνια
  - 234. Μεντεσέδες
  - 239. Καταβάτες - Σύρτες
  - 242. Σύρτες
  - 244. Γωνίες - Λάμες - Χειρολαβές
  - 245. Στηρίγματα τζαμιών - Στοπ πόρτας
  - 246. Ναυτικά κλειδιά
  - 248. Συρματόσχοινα - Σφυγκτήρες - Ταλουρίτ
  - 249. Άκρα συρματόσχοινο
  - 250. Άκρα πρέσσας
  - 252. Εντατήρες συρματόσχοινων
  - 255. Γάντζοι αλυσίδας
  - 256. Στριφτάρια - Πυροσβεστικοί γάντζοι
  - 258. Κρεμάστρες - Στραβόβιδες - Γαντζόβιδες
  - 259. Ράουλα - Τροχαλίες
  - 260. Χούφτες - Ωμέγα
  - 261. Μάπες
  - 262. Βιδοθηλιές - U-bolts
  - 263. Περσίδες
  - 264. Αεραγωγοί - Σύρμα - Σίτες - Πλέγματα
  - 265. Τάπες - Οπές - Βαλβίδες
  - 266. Εξαρτήματα σωλήνων
  - 271. Εξαρτήματα υδραυλικών σωλήνων
  - 272. Κοτσανέλα
  - 273. Κοτσανέλα - Δέστρες - Γλύστρες
  - 274. Στριφτάρια - Αγκυρες - Αλυσίδες

Α Β Γ Δ Ε Ζ Η Θ Ι Κ Λ Μ Ν Ξ Ο Π Ρ Σ Τ Υ Φ Χ Ψ Ω





















































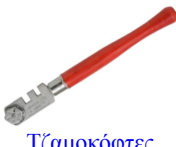

















<p>Σ. 262</p>  <p>U-bolts</p>	<p>Σ. 270</p> <p><b>A</b></p>  <p>Αγκράφες</p>	<p>Σ. 274</p>  <p>Αγκυρες</p>	<p>Σ. 264</p>  <p>Αεραγωγοί</p>	<p>Σ. 99</p>  <p>Αεροκαστάνιες</p>	<p>Σ. 99</p>  <p>Αερόκλειδα</p>	<p>Σ. 19</p>  <p>Αδιάβροχα</p>
<p>Σ. 250</p>  <p>Ακρα πρέσσας</p>	<p>Σ. 249</p>  <p>Άκρα συρματόσχοινο</p>	<p>Σ. 46</p>  <p>Ακονόπετρες</p>	<p>Σ. 166</p>  <p>Ακουστικά κινητήρα</p>	<p>Σ. 226</p>  <p>Αλενόβιδες</p>	<p>Σ. 80</p>  <p>Άλλεν κλειδιά</p>	<p>Σ. 151</p>  <p>Αλοιφές γυαλισματος</p>
<p>Σ. 146</p>  <p>Αλοιφές κοπτικών</p>	<p>Σ. 208</p>  <p>Αλφάδια</p>	<p>Σ. 274</p>  <p>Αλυσίδες</p>	<p>Σ. 188</p>  <p>Αμόνια</p>	<p>Σ. 23</p>  <p>Αναδέτες σύνδεσης</p>	<p>Σ. 43</p>  <p>Αναπτήρες BBQ</p>	<p>Σ. 23</p>  <p>Ανασχετήρες ασφαλείας</p>
<p>Σ. 36</p>  <p>Ανταλλακτικά πυρογράφου</p>	<p>Σ. 36</p>  <p>Ανταλλακτικά χαβιά αερίου</p>	<p>Σ. 39</p>  <p>Αντάπτορες αερίου</p>	<p>Σ. 58</p>  <p>Αντάπτορες βιδολόγων</p>	<p>Σ. 141</p>  <p>Αντάπτορες ποτηροτρύπανων</p>	<p>Σ. 163</p>  <p>Αντίστροφα κολαούζα</p>	<p>Σ. 68</p>  <p>Απογυμνωτές καλωδίων</p>
<p>Σ. 150</p>  <p>Αποφρακτικά υγρά</p>	<p>Σ. 71</p>  <p>Αρπάγες</p>	<p>Σ. 230</p>  <p>Ασφάλειες άξονος</p>	<p>Σ. 232</p>  <p>Ασφάλειες εντατήρα</p>	<p>Σ. 231</p>  <p>Ασφάλειες μισοφέγγαρες</p>	<p>Σ. 232</p>  <p>Ασφάλειες πύρου</p>	<p>Σ. 230</p>  <p>Ασφάλειες τρύπας</p>
<p>Σ. 149</p>  <p>Ασφαλιστικά μπουλονιών</p>	<p>Σ. 149</p>  <p>Ατσαλοστοκοι</p>	<p>Σ. 155</p>  <p>Αυτοκόλλητες μεζούρες</p>	<p>Σ. 265</p> <p><b>B</b></p>  <p>Βαλβίδες εξαέρωσης</p>	<p>Σ. 29</p>  <p>Βαλίτσες</p>	<p>Σ. 271</p>  <p>Βάνες</p>	<p>Σ. 201</p>  <p>Βαριοπούλες</p>
<p>Σ. 270</p>  <p>Βάσεις κάθετες</p>	<p>Σ. 266</p>  <p>Βάσεις κεραίας</p>	<p>Σ. 270</p>  <p>Βάσεις κούρμπα</p>	<p>Σ. 267</p>  <p>Βάσεις λοξές</p>	<p>Σ. 270</p>  <p>Βάσεις με βίδα - πύρο</p>	<p>Σ. 268</p>  <p>Βάσεις σπαστές για ποτήρι</p>	<p>Σ. 268</p>  <p>Βάσεις σωλήνα σκάλας</p>
<p>Σ. 202</p>  <p>Βελόνια</p>	<p>Σ. 142</p>  <p>Βελόνια SDS</p>	<p>Σ. 149</p>  <p>Βενζινοκόλλες</p>	<p>Σ. 164</p>  <p>Βεντούζες λείανσης βαλβίδων</p>	<p>Σ. 123</p>  <p>Βεντούζες τζαμιών</p>	<p>Σ. 15</p>  <p>Βερμούδες</p>	<p>Σ. 117</p>  <p>Βίδες θηλιές με βύσμα</p>
<p>Σ. 120</p>  <p>Βίδες ντίζες</p>	<p>Σ. 263</p>  <p>Βιδοθηλιές inox</p>	<p>Σ. 217</p>  <p>Βιδωτά κολάρα σφυγκτήρες</p>	<p>Σ. 218</p>  <p>Βιδωτά κολάρα σφυγκτήρες inox</p>	<p>Σ. 44</p>  <p>Βίντσια</p>	<p>Σ. 214</p>  <p>Βολάν</p>	<p>Σ. 117</p>  <p>Βύσματα βαρέως τύπου</p>
<p>Σ. 116</p>  <p>Βύσματα γυροσανίδας</p>	<p>Σ. 118</p>  <p>Βύσματα θερμopρόσοψης</p>	<p>Σ. 117</p>  <p>Βύσματα με εξάγωνο άξονα</p>	<p>Σ. 120</p>  <p>Βύσματα ντίζας</p>	<p>Σ. 115</p>  <p>Βύσματα ξύλου</p>	<p>Σ. 225</p>  <p>Βύσματα ξύλου inox</p>	<p>Σ. 116</p>  <p>Βύσματα τοίχου</p>























<p>Σ . 121</p>  <p>Βύσματα χτυπητά</p>	<p>Σ . 225</p>  <p>Βύσματα χτυπητά inox</p>	<p>Σ . 75</p>  <p>Γαλλικά κλειδιά</p>	<p>Σ . 232</p>  <p>Γάντζοι "S"</p>	<p>Σ . 255</p>  <p>Γάντζοι αλυσίδας</p>	<p>Σ . 258</p>  <p>Γάντζοι βίδα</p>	<p>Σ . 118</p>  <p>Γάντζοι γυφτοσανίδας</p>
<p>Σ . 255</p>  <p>Γάντζοι με πύρο</p>	<p>Σ . 257</p>  <p>Γάντζοι με στριφτάρι</p>	<p>Σ . 23</p>  <p>Γάντζοι πυροσβεστικοί</p>	<p>Σ . 75</p>  <p>Γαντζόκλειδα</p>	<p>Σ . 25</p>  <p>Γάντια</p>	<p>Σ . 68</p>  <p>Γδάρτες καλωδίων</p>	<p>Σ . 75</p>  <p>Γερμανικά κλειδιά</p>
<p>Σ . 76</p>  <p>Γερμανοπολύγωνα</p>	<p>Σ . 163</p>  <p>Γέφυρες εσωτερικών εξολκείων</p>	<p>Σ . 162</p>  <p>Γέφυρες πιάτων ρουλεμάν</p>	<p>Σ . 18</p>  <p>Γλέκα</p>	<p>Σ . 43</p>  <p>Γκαζάκια υγραερίου</p>	<p>Σ . 73</p>  <p>Γκαζοτανάλιες</p>	<p>Σ . 74</p>  <p>Γκριπ</p>
<p>Σ . 222</p>  <p>Γκρόβερ inox</p>	<p>Σ . 273</p>  <p>Γλύστρες</p>	<p>Σ . 150</p>  <p>Γράσα</p>	<p>Σ . 209</p>  <p>Γρασαδοράκια Γρασαδόροι</p>	<p>Σ . 195</p>  <p>Γυαλιά ηλεκτροκόλλησης</p>	<p>Σ . 21</p>  <p>Γυαλιά προστασίας</p>	<p>Σ . 244</p>  <p>Γωνίες</p>
<p>Σ . 258</p>  <p>Γωνίες βίδα</p>	<p>Σ . 244</p>  <p>Γωνίες πλακέ</p>	<p>Σ . 244</p>  <p>Γωνίες ραφιών</p>	<p>Σ . 155</p>  <p>Γωνίες σιδηρουργού</p>	<p>Σ . 157</p>  <p>Γωνίες Στέλλα</p>	<p>Σ . 244</p>  <p>Γωνίες τραπεζοειδείς</p>	<p>Σ . 268</p>  <p>Γωνίες σωλήνων σκάφους</p>
<p>Σ . 232</p>  <p>Δέλτα</p>	<p>Σ . 273</p>  <p>Δέστρες</p>	<p>Σ . 157</p>  <p>Διαβήτες</p>	<p>Σ . 151</p>  <p>Διαλυτικά νίτρου</p>	<p>Σ . 138</p>  <p>Διαμαντόδισκοι</p>	<p>Σ . 106</p>  <p>Διαμαντοκεφαλές</p>	<p>Σ . 130</p>  <p>Διαμαντολεπίδες σέγας</p>
<p>Σ . 132</p>  <p>Διαμαντολεπίδες σπαθοσέγας</p>	<p>Σ . 104</p>  <p>Διαμαντοτρύπανα</p>	<p>Σ . 270</p>  <p>Διαμπερείς σωλήνες</p>	<p>Σ . 160</p>  <p>Δίποδα σέτ εξολκείων</p>	<p>Σ . 136</p>  <p>Δίσκοι κοπής - λειάνσης</p>	<p>Σ . 47</p>  <p>Δοκιμαστικά καταβίδια</p>	<p>Σ . 183</p>  <p>Δυναμόκλειδα</p>
<p>Σ . 43</p>  <p>Ελαστικά σχοινιά</p>	<p>Σ . 180</p>  <p>Ελατηρια επιδιόρθωσης</p>	<p>Σ . 175</p>  <p>Ελικοειδή κολαούζα</p>	<p>Σ . 67</p>  <p>Εμπροσθοκόφτες</p>	<p>Σ . 252</p>  <p>Εντατήρες συρματοσχοινίων</p>	<p>Σ . 219</p>  <p>Εξάγωνες βίδες</p>	<p>Σ . 161</p>  <p>Εξολκείς αδρανείας</p>
<p>Σ . 160</p>  <p>Εξολκείς ακρόμπαραν</p>	<p>Σ . 164</p>  <p>Εξολκείς βαλβίδων</p>	<p>Σ . 158</p>  <p>Εξολκείς δίποδοι - τρίποδοι</p>	<p>Σ . 163</p>  <p>Εξολκείς ελατηρίων</p>	<p>Σ . 161</p>  <p>Εξολκείς μουζονιών</p>	<p>Σ . 162</p>  <p>Εξολκείς ρουλεμάν</p>	<p>Σ . 24</p>  <p>Επιγονατίδες</p>
<p>Επιφάνειες κοπής</p>	<p>Σ . 149</p>  <p>Εποξικές κόλλες</p>	<p>Σ . 36</p>  <p>Εργαλεία φελιζόλ</p>	<p>Σ . 26</p>  <p>Εργαλειοθήκες</p>	<p>Σ . 20</p>  <p>Εσωθερμικά</p>	<p>Σ . 145</p>  <p>Εύκαμπτα σπείрал - αρπάγες</p>	<p>Σ . 239</p>  <p>Ζεμπερέκια πόρτας</p>

<p>Σ. 170</p>  <p>Ζουμπάδες</p>	<p>Σ. 115</p>  <p>Ζυγκιά</p>	<p>Σ. 15</p>  <p>Ζώνες</p>	<p>Σ. 23</p>  <p>Ζώνες ανάσχεσης πτώσης</p>	<p>Σ. 197</p>  <p>Ηλεκτρόδια</p>	<p>Σ. 32</p>  <p>Θήκες ζώνης</p>	<p>Σ. 26</p>  <p>Θήκες υλικών</p>
<p>Σ. 32</p>  <p>Θήκες κινητών - tablet</p>	<p>Σ. 118</p>  <p>Θηλιές γυροσανίδας</p>	<p>Σ. 117</p>  <p>Θηλιές με βύσμα</p>	<p>Σ. 44</p>  <p>Ιμάντες</p>	<p>Σ. 231</p>  <p>Καβίλες</p>	<p>Σ. 73</p>  <p>Κάβουρες αλουμινίου</p>	<p>Σ. 150</p>  <p>Καθαριστικά</p>
<p>Σ. 35</p>  <p>Καλάι</p>	<p>Σ. 202</p>  <p>Καλέμα</p>	<p>Σ. 142</p>  <p>Καλέμα SDS</p>	<p>Σ. 15</p>  <p>Κάλτσες</p>	<p>Σ. 124</p>  <p>Κανάτες ογκομέτρησης</p>	<p>Σ. 114</p>  <p>Καρβίδια</p>	<p>Σ. 89</p>  <p>Καρυδάκια</p>
<p>Σ. 84</p>  <p>Καρυδάκια σετ</p>	<p>Σ. 52</p>  <p>Καρυδάκια Ταφ</p>	<p>Σ. 224</p>  <p>Κασονόβιδες inox</p>	<p>Σ. 90</p>  <p>Καστάνιες</p>	<p>Σ. 179</p>  <p>Καστάνιες κολαούζων</p>	<p>Σ. 239</p>  <p>Καταβάτες</p>	<p>Σ. 47</p>  <p>Κατσαβίδια</p>
<p>Σ. 141</p>  <p>Κεντραδόροι κοπτικών</p>	<p>Σ. 111</p>  <p>Κεντραδόροι τόνου</p>	<p>Σ. 146</p>  <p>Κεριά κοπτικών</p>	<p>Σ. 133</p>  <p>Κλαδευτήρια</p>	<p>Σ. 199</p>  <p>Κλειδαριές</p>	<p>Σ. 80</p>  <p>Κλειδιά γωνιακά allen, torx κλπ</p>	<p>Σ. 78</p>  <p>Κλειδιά με πύρους</p>
<p>Σ. 71</p>  <p>Κλειδιά φίλτρου</p>	<p>Σ. 173</p>  <p>Κολαούζα</p>	<p>Σ. 149</p>  <p>Κόλλες</p>	<p>Σ. 35</p>  <p>Κολλητήρια</p>	<p>Σ. 144</p>  <p>Κονδύλια</p>	<p>Σ. 202</p>  <p>Κοπίδια</p>	<p>Σ. 142</p>  <p>Κοπίδια SDS</p>
<p>Σ. 230</p>  <p>Κοπίλιες inox</p>	<p>Σ. 139</p>  <p>Κοπτικά τρύπας μετάλλων</p>	<p>Σ. 15</p>  <p>Κορδόνια παπουτσιών</p>	<p>Σ. 272</p>  <p>Κοτσανέλα</p>	<p>Σ. 203</p>  <p>Κουβάδες</p>	<p>Σ. 74</p>  <p>Κουρμαδόροι</p>	<p>Σ. 157</p>  <p>Κουμπάσα</p>
<p>Σ. 65</p>  <p>Κόφτες καλωδίων</p>	<p>Σ. 161</p>  <p>Κόφτες</p>	<p>Σ. 67</p>  <p>Κόφτες σύρματος</p>	<p>Σ. 24</p>  <p>Κράνη ασφαλείας</p>	<p>Σ. 258</p>  <p>Κρεμάστρες</p>	<p>Σ. 233</p>  <p>Κρίκοι</p>	<p>Σ. 168</p>  <p>Κρουστικά κατσαβίδια</p>
<p>Σ. 199</p>  <p>Κύλινδροι κλειδαριών</p>	<p>Σ. 200</p>  <p>Κυπρί</p>	<p>Σ. 141</p>  <p>Κώνικες φρέζες</p>	<p>Σ. 181</p>  <p>Κώνοι</p>	<p>Σ. 195</p>  <p>Λαβές λίμας</p>	<p>Σ. 41</p>  <p>Λαβές οξυγονοκόλλησης</p>	<p>Σ. 194</p>  <p>Λαβές τουμπόβουρτσας</p>
<p>Σ. 210</p>  <p>Λαδικά</p>	<p>Σ. 229</p>  <p>Λαμαρινόβιδες</p>	<p>Σ. 244</p>  <p>Λάμες πλακέ</p>	<p>Σ. 135</p>  <p>Λάμες σιδηροπρίονου</p>	<p>Σ. 161</p>  <p>Λεβιέδες ελαστικών</p>	<p>Σ. 213</p>  <p>Λεβιέδες καστάνιας</p>	<p>Σ. 190</p>  <p>Λειαντικά δραπάνου</p>

<p>Σ. 128</p> <p>Λεπίδες σέγας</p>	<p>Σ. 131</p> <p>Λεπίδες σπαθοσέγας</p>	<p>Σ. 127</p> <p>Λεπίδες σπαστές - τραπεζοειδείς</p>	<p>Σ. 195</p> <p>Λιμες</p>	<p>Σ. 146</p> <p>Λιπαντικά κοπτικών</p>	<p>Σ. 198</p> <p>Λουκέτα</p>	<p>Σ. 216</p> <p>Μαγνήτες</p>
<p>Σ. 94</p> <p>Μαγνητικά καρυδάκια</p>	<p>Σ. 123</p> <p>Μαγνητικά πιάτα</p>	<p>Σ. 58</p> <p>Μαγνητικοί αντάπτορες</p>	<p>Σ. 145</p> <p>Μαγνητιστές - απομαγνητιστές</p>	<p>Σ. 203</p> <p>Μακαράδες</p>	<p>Σ. 186</p> <p>Μάνδαλα</p>	<p>Σ. 91</p> <p>Μανέλες</p>
<p>Σ. 179</p> <p>Μανέλες κολαούζων</p>	<p>Σ. 239</p> <p>Μάνταλα πόρτας</p>	<p>Σ. 261</p> <p>Μάπες</p>	<p>Σ. 53</p> <p>Μαρκαδόροι ανεξίτηλοι</p>	<p>Σ. 196</p> <p>Μάσκες ηλεκτροκόλλησης</p>	<p>Σ. 22</p> <p>Μάσκες κυπελοειδείς</p>	<p>Σ. 21</p> <p>Μάσκες γυαλιά</p>
<p>Σ. 201</p> <p>Ματσακόνια</p>	<p>Σ. 201</p> <p>Ματσόλες</p>	<p>Σ. 143</p> <p>Μαχαίρια τόννου</p>	<p>Σ. 41</p> <p>Μειωτήρες αερίου</p>	<p>Σ. 234</p> <p>Μεντεσεδες</p>	<p>Σ. 120</p> <p>Μεταλλικά βύσματα</p>	<p>Σ. 154</p> <p>Μετροταινίες</p>
<p>Σ. 223</p> <p>Μηχανόβιδες inox</p>	<p>Σ. 156</p> <p>Μικρόμετρα</p>	<p>Σ. 157</p> <p>Μοιρογνωμόνια</p>	<p>Σ. 40</p> <p>Μολυβδοκόλληση</p>	<p>Σ. 53</p> <p>Μολύβια</p>	<p>Σ. 125</p> <p>Μονωτικές ταινίες</p>	<p>Σ. 188</p> <p>Μόρσες</p>
<p>Σ. 34</p> <p>Μπανάνες μέσης</p>	<p>Σ. 30</p> <p>Μπαούλα</p>	<p>Σ. 42</p> <p>Μπεκ κοπής</p>	<p>Σ. 124</p> <p>Μπετόνια</p>	<p>Σ. 122</p> <p>Μπετονόβιδες</p>	<p>Σ. 231</p> <p>Μποζόνια</p>	<p>Σ. 14</p> <p>Μποτάκια ασφαλείας</p>
<p>Σ. 18</p> <p>Μπουφάν</p>	<p>Σ. 40</p> <p>Μπρουντζοκόλληση</p>	<p>Σ. 54</p> <p>Μύτες καταβιδιών</p>	<p>Σ. 63</p> <p>Μυτοτσιμπίδα</p>	<p>Σ. 246</p> <p>Ναυτικά κλειδιά</p>	<p>Σ. 271</p> <p>Νίτελ</p>	<p>Σ. 228</p> <p>Νοβοπανόβιδες</p>
<p>Σ. 220</p> <p>Ντιζες</p>	<p>Σ. 211</p> <p>Ντιζες τραπεζοειδείς</p>	<p>Σ. 126</p> <p>Νυστέρια</p>	<p>Σ. 119</p> <p>Ευλόβιδες</p>	<p>Σ. 207</p> <p>Εύστρες</p>	<p>Σ. 172</p> <p>Εύστρες φλαντζών</p>	<p>Σ. 107</p> <p>Οδηγοί για ποτηροκόρωνες</p>
<p>Σ. 155</p> <p>Οδόμετρα</p>	<p>Σ. 40</p> <p>Οξυγονοκολλήσεις</p>	<p>Σ. 265</p> <p>Οπές κύτους</p>	<p>Σ. 41</p> <p>Παγίδες φλόγας</p>	<p>Σ. 16</p> <p>Παντελόνια εργασίας</p>	<p>Σ. 13</p> <p>Παπούτσια</p>	<p>Σ. 15</p> <p>Πάτοι παπουτσιών</p>
<p>Σ. 203</p> <p>Πατόφτυαρά</p>	<p>Σ. 156</p> <p>Παχύμετρα</p>	<p>Σ. 59</p> <p>Πένσες</p>	<p>Σ. 60</p> <p>Πένσες ασφαλειών</p>	<p>Σ. 72</p> <p>Πένσες κολιέδων</p>	<p>Σ. 59</p> <p>Πένσες μολυβδοσφραγίδων</p>	<p>Σ. 205</p> <p>Πεντάλ ανύψωσης</p>

<p>Σ. 220</p>  <p>Περικόχλια</p>	<p>Σ. 232</p>  <p>Περόνες</p>	<p>Σ. 263</p>  <p>Περσίδες</p>	<p>Σ. 169</p>  <p>Περσιναδόροι</p>	<p>Σ. 170</p>  <p>Περτσίνια</p>	<p>Σ. 233</p>  <p>Περτσίνια inox</p>	<p>Σ. 233</p>  <p>Περτσίνια μασίφ</p>
<p>Σ. 233</p>  <p>Περτσίνια με πάσο</p>	<p>Σ. 161</p>  <p>Πηρούνες εξολκέων</p>	<p>Σ. 162</p>  <p>Πιάτα για ρουλεμάν</p>	<p>Σ. 222</p>  <p>Πιατάκια μασίφ</p>	<p>Σ. 204</p>  <p>Πιστόλια αφρού πολουρεθάνης</p>	<p>Σ. 204</p>  <p>Πιστόλια σιλικόνης</p>	<p>Σ. 65</p>  <p>Πλαγιοκόφτες</p>
<p>Σ. 264</p>  <p>Πλέγματα</p>	<p>Σ. 215</p>  <p>Πόδια βιδωτά</p>	<p>Σ. 159</p>  <p>Πόδια για εξολκείς</p>	<p>Σ. 77</p>  <p>Πολύγωνα</p>	<p>Σ. 212</p>  <p>Πόμολα</p>	<p>Σ. 182</p>  <p>Πόντες τήνου</p>	<p>Σ. 266</p>  <p>Ποτήρια σωλήνα</p>
<p>Σ. 107</p>  <p>Ποτηροκορώνες</p>	<p>Σ. 140</p>  <p>Ποτηροτρύπανα</p>	<p>Σ. 70</p>  <p>Πρέσες ακροδεκτών</p>	<p>Σ. 205</p>  <p>Πρέσες γυψοσανίδων</p>	<p>Σ. 135</p>  <p>Πριόνια γυψοσανίδας</p>	<p>Σ. 135</p>  <p>Πριόνια μετάλλου</p>	<p>Σ. 135</p>  <p>Πριόνια ξύλου</p>
<p>Σ. 136</p>  <p>Πριονοκορδέλες</p>	<p>Σ. 135</p>  <p>Πριονόλαμες</p>	<p>Σ. 209</p>  <p>Προεκτάσεις γρασαδόρου</p>	<p>Σ. 91</p>  <p>Προεκτάσεις καστανίας</p>	<p>Σ. 64</p>  <p>Προσέλες</p>	<p>Σ. 36</p>  <p>Πυρογράφοι</p>	<p>Σ. 232</p>  <p>Πίροι εντατήρα</p>
<p>Σ. 42</p>  <p>Πυροκόφτες</p>	<p>Σ. 256</p>  <p>Πυροσβεστικοί γάντζοι</p>	<p>Σ. 149</p>  <p>Ράβδοι σιλικόνης</p>	<p>Σ. 271</p>  <p>Ρακόρ</p>	<p>Σ. 259</p>  <p>Ράουλα</p>	<p>Σ. 205</p>  <p>Ράσπες</p>	<p>Σ. 155</p>  <p>Ρίγες</p>
<p>Σ. 248</p>  <p>Ροδάντζες</p>	<p>Σ. 222</p>  <p>Ροδέλες</p>	<p>Σ. 41</p>  <p>Ρυθμιστές αερίου</p>	<p>Σ. 188</p>  <p>Σαπόρτ</p>	<p>Σ. 146</p>  <p>Σαπουνέλαια</p>	<p>Σ. 172</p>  <p>Σγρόπιες</p>	<p>Σ. 51</p>  <p>Σειρές καταβιδιών</p>
<p>Σ. 88</p>  <p>Σετ εργαλεία</p>	<p>Σ. 84</p>  <p>Σετ καρυδάκια</p>	<p>Σ. 53</p>  <p>Σημαδευτήρια</p>	<p>Σ. 135</p>  <p>Σιδηροπριόνια</p>	<p>Σ. 149</p>  <p>Σιλικόνη σε ράβδους</p>	<p>Σ. 264</p>  <p>Σίτες</p>	<p>Σ. 204</p>  <p>Σκαπανοστέκουρα</p>
<p>Σ. 46</p>  <p>Σκαρπέλα</p>	<p>Σ. 20</p>  <p>Σκουφάκια</p>	<p>Σ. 202</p>  <p>Σκύλες</p>	<p>Σ. 35</p>  <p>Σολντερίνη</p>	<p>Σ. 53</p>  <p>Σουβλιά</p>	<p>Σ. 200</p>  <p>Σούστες πόρτας</p>	<p>Σ. 206</p>  <p>Σπάτουλες</p>
<p>Σ. 195</p>  <p>Σπειρολίμες</p>	<p>Σ. 157</p>  <p>Σπειρόμετρα</p>	<p>Σ. 152</p>  <p>Σπρέι RAL</p>	<p>Σ. 150</p>  <p>Σπρέι αέρας</p>	<p>Σ. 153</p>  <p>Σπρέι βαφής αντισκωριακά</p>	<p>Σ. 147</p>  <p>Σπρέι αντισκωριακά</p>	<p>Σ. 148</p>  <p>Σπρέι γράσο</p>

<p>Σ. 153</p>  <p>Σπρέι τεχνικά</p>	<p>Σ. 268</p>  <p>Σταυροί σωλήνων</p>	<p>Σ. 171</p>  <p>Στένσιλ</p>	<p>Σ. 115</p>  <p>Στηρίγματα σωλήνα</p>	<p>Σ. 245</p>  <p>Στηρίγματα τζαμιών</p>	<p>Σ. 206</p>  <p>Στοκαδόροι</p>	<p>Σ. 245</p>  <p>Στοπ πόρτας</p>
<p>Σ. 248</p>  <p>Στοπ συρματοσχοινου</p>	<p>Σ. 255</p>  <p>Στριφτάρια</p>	<p>Σ. 122</p>  <p>Στριφώνια γαλβανιζέ</p>	<p>Σ. 228</p>  <p>Στριφώνια inox</p>	<p>Σ. 119</p>  <p>Στριφονόβιδες γαλβανιζέ</p>	<p>Σ. 228</p>  <p>Στριφονόβιδες inox</p>	<p>Σ. 246</p>  <p>Σύνδεσμοι αλυσίδας</p>
<p>Σ. 267</p>  <p>Σύνδεσμοι σωλήνων</p>	<p>Σ. 249</p>  <p>Συνδετήρες κόμβου</p>	<p>Σ. 264</p>  <p>Σύρμα μαλακό</p>	<p>Σ. 191</p>  <p>Συρματόβουρτσες</p>	<p>Σ. 242</p>  <p>Σύρτες</p>	<p>Σ. 271</p>  <p>Συστολές σωλήνων</p>	<p>Σ. 101</p>  <p>Συστολές για καρδιάκια αέρος</p>
<p>Σ. 92</p>  <p>Συστολές μανέλας</p>	<p>Σ. 211</p>  <p>Σφήνες</p>	<p>Σ. 230</p>  <p>Σφήνες inox</p>	<p>Σ. 181</p>  <p>Σφηνοβγάλτες</p>	<p>Σ. 217</p>  <p>Σφιγκτήρες κολάρων</p>	<p>Σ. 218</p>  <p>Σφιγκτήρες κολάρων inox</p>	<p>Σ. 186</p>  <p>Σφιγκτήρες μαραγκών</p>
<p>Σ. 248</p>  <p>Σφιγκτήρες συρματοσχοινου</p>	<p>Σ. 201</p>  <p>Σφυριά</p>	<p>Σ. 43</p>  <p>Σχοινιά</p>	<p>Σ. 248</p>  <p>Συρματόσχοινα</p>	<p>Σ. 271</p>  <p>Σωληνομαστοί</p>	<p>Σ. 78</p>  <p>Σωληνωτά κλειδιά</p>	<p>Σ. 125</p>  <p>Ταινίες αυτοκόλλητες</p>
<p>Σ. 248</p>  <p>Ταλουρίτ</p>	<p>Σ. 26</p>  <p>Ταμπακιέρες</p>	<p>Σ. 214</p>  <p>Τάπες περικοχλίων</p>	<p>Σ. 216</p>  <p>Τάπες ποδιών</p>	<p>Σ. 72</p>  <p>Ταπόκλειδα</p>	<p>Σ. 74</p>  <p>Ταπόνια</p>	<p>Σ. 52</p>  <p>Ταφ</p>
<p>Σ. 123</p>  <p>Τζαμοκόφτες</p>	<p>Σ. 206</p>  <p>Τηλεσκοπικοί βραχιόνες</p>	<p>Σ. 145</p>  <p>Τηλεσκοπικοί καθρέπτες</p>	<p>Σ. 145</p>  <p>Τηλεσκοπικοί μαγνήτες</p>	<p>Σ. 194</p>  <p>Τουμπόβουρτσες</p>	<p>Σ. 164</p>  <p>Τραβηχτήρια σύρματος</p>	<p>Σ. 259</p>  <p>Τροχαλίες</p>
<p>Σ. 104</p>  <p>Τρυπάνια δομικών υλικών</p>	<p>Σ. 108</p>  <p>Τρυπάνια μέταλλου</p>	<p>Σ. 112</p>  <p>Τρυπάνια ξύλου</p>	<p>Σ. 216</p>  <p>Τρυπανόβιδες</p>	<p>Σ. 175</p>  <p>Τρυπανοκολαούζα</p>	<p>Σ. 59</p>  <p>Τρυπητήρια δέρματος</p>	<p>Σ. 28</p>  <p>Τσάντες εργαλείων</p>
<p>Σ. 204</p>  <p>Τσεκούρια</p>	<p>Σ. 116</p>  <p>Τσέρκια</p>	<p>Σ. 195</p>  <p>Τσιμιπίδες ηλεκτροκόλλησης</p>	<p>Σ. 73</p>  <p>Τσιμιπίδες υδραυλικού</p>	<p>Σ. 182</p>  <p>Τσοκ δραπάνου</p>	<p>Σ. 204</p>  <p>Τσουβαλοδέτες</p>	<p>Σ. 149</p>  <p>Υγρό τεφλόν</p>
<p>Σ. 271</p>  <p>Υδραυλικά εξαρτήματα</p>	<p>Σ. 45</p>  <p>Φακοί</p>	<p>Σ. 126</p>  <p>Φαλτσέτες</p>	<p>Σ. 40</p>  <p>Φιάλες αερίου</p>	<p>Σ. 177</p>  <p>Φιλιέρες</p>	<p>Σ. 157</p>  <p>Φύλλερ</p>	<p>Σ. 125</p>  <p>Φίλμ χειρός</p>

<p>Σ. 172</p>  <p>Φλαντζοκόφτες</p>	<p>Σ. 20</p>  <p>Φλις εργασίας</p>	<p>Σ. 37</p>  <p>Φλόγιστρα</p>	<p>Σ. 17</p>  <p>Φόρμες εργασίας</p>	<p>Σ. 111</p>  <p>Φρεζάκια</p>	<p>Σ. 203</p>  <p>Φτυάρια</p>	<p>Σ. 181</p>  <p>Φωλιές</p>
<p>Σ. 40</p>  <p>Χαλκοκόλληση</p>	<p>Σ. 125</p>  <p>Χαρτοταινίες</p>	<p>Σ. 244</p>  <p>Χειρολαβές inox</p>	<p>Σ. 214</p>  <p>Χειρολαβές νάυλον</p>	<p>Σ. 120</p>  <p>Χημικά αγκύρια</p>	<p>Σ. 260</p>  <p>Χούφτες</p>	<p>Σ. 121</p>  <p>Χτυπητά βύσματα</p>
<p>Σ. 225</p>  <p>Χτυπητά βύσματα inox</p>	<p>Σ. 171</p>  <p>Χτυπητά γράμματα</p>	<p>Σ. 124</p>  <p>Χωνιά</p>	<p>Σ. 133</p>  <p>Ψαλίδια</p>	<p>Σ. 66</p>  <p>Ψαλίδια καλωδίων</p>	<p>Σ. 134</p>  <p>Ψαλίδια λαμαρίνας</p>	<p>Σ. 74</p>  <p>Ψαλίδια τουμποράματος</p>
<p>Σ. 260</p>  <p>Ωμέγα</p>	<p>Σ. 22</p>  <p>Ωτασπίδες</p>					

**Αθλητικά παπούτσια μαύρα**



χωρίς ασφάλεια



Κωδικός	Μέγεθος
43211	41
43212	42

**Kapriol**

**Αθλητικά παπούτσια μπλε**



χωρίς ασφάλεια



Κωδικός	Μέγεθος
43221	41
43226	46

**Kapriol**

**Αθλητικά παπούτσια γκρι**



χωρίς ασφάλεια



Κωδικός	Μέγεθος
43201	41
43202	42
43205	45
43206	46

**Kapriol**

**Αθλητικά παπούτσια γκρι**

χωρίς ασφάλεια



Κωδικός	Μέγεθος
43740	40
43741	41
43742	42
43743	43
43744	44
43745	45
43746	46
43747	47

**ENDURO**

**Kapriol**

**Αθλητικά παπούτσια ασφαλείας S3 μπλε**



Κωδικός	Μέγεθος
41980	40
41981	41
41982	42
41983	43
41984	44
41985	45
41986	46
41987	47



**DERBY BLUE**

**Kapriol**

**Αθλητικά παπούτσια ασφαλείας S3**



Κωδικός	Μέγεθος
43600	40
43601	41
43602	42
43603	43
43604	44
43605	45
43606	46



**WALKER**

**Kapriol**

**Αθλητικά παπούτσια γκρι - πορτοκαλί**

Αδιάβροχα χωρίς ασφάλεια

Κωδικός	Μέγεθος
43760	40
43761	41
43762	42
43763	43
43764	44
43765	45
43766	46
43767	47



**ENDURO HIGH**

**Kapriol**



### Παπούτσια ασφαλείας S1P καφέ



**SIOUX LOW**

Κωδικός	Μέγεθος
41031 NEW	41
41032 NEW	42
41034 NEW	44
41035 NEW	45
41036 NEW	46

**Kapriol®**

### Μποτάκια ασφαλείας S1P καφέ



**SIOUX HIGH**

Κωδικός	Μέγεθος
41040 NEW	40
41041 NEW	41
41042 NEW	42
41043 NEW	43
41044 NEW	44
41045 NEW	45
41046 NEW	46
41047 NEW	47

**Kapriol®**

### Μποτάκια ασφαλείας S3 καφέ



**PATROL**

Κωδικός	Μέγεθος
43041	41
43042	42
43043	43
43044	44
43045	45
43046	46

**Kapriol®**

### Μποτάκια ασφαλείας S3 μαύρα



**SPENCER**

Κωδικός	Μέγεθος
41970	40
41971	41
41972	42
41973	43
41974	44
41975	45
41976	46
41977	47

**Kapriol®**

**Πάτοι παπουτσιών**

Gel μόνο στην φτέρνα  
EVA GEL



Κωδικός	Μέγεθος
42125	39-40
42126	41-42
42127	43-44
42128	45-47

**Kapriol**

**Πάτοι παπουτσιών GEL**

GEL



Κωδικός	Μέγεθος
42113	39-41
42114	42-44
42115	45-47

**Kapriol**

**Κάλτσες 60% βαμβάκι**

Με απόσβεση κραδασμών



Κωδικός	Μέγεθος
32107	39-41 (M)
32108	42-44 (L)
32109	45-47 (XL)

**Kapriol**

**Κάλτσες 75% βαμβάκι**



Κωδικός	Μέγεθος
32092	39-41 (M)
32093	42-44 (L)
32094	45-47 (XL)

**Kapriol**

**Κάλτσες 75% βαμβάκι κοντές**



Κωδικός	Μέγεθος
32087	39-41 (M)
32088	42-44 (L)
32089	45-47 (XL)

**Kapriol**

**Σπρέι  
αδιαβρογοποίησης** **NEO**  
200ml



Κωδικός
42100

**Kapriol**

**Κορδόνια παπουτσιών**



Κωδικός
42105

**Kapriol**

**Δερμάτινη ζώνη**



Κωδικός
25013

**Kapriol**

**Πολυεστερική ζώνη  
μαύρη**



Κωδικός
25037

**Kapriol**

**Βερμούδα εργασίας μπεζ**



**KAVIR**

Κωδικός	Μέγεθος
31590	M
31591	L
31592	XL
31593	XXL

**Kapriol**

**Βερμούδα εργασίας γκρι**

97% βαμβάκι  
3% ελαστάν



**TENERE PRO**

Κωδικός	Μέγεθος
32534	M
32535	L
32536	XL
32537	XXL

**Kapriol**



**Παντελόνι εργασίας γκρι**



**TENERE**

Κωδικός	Μέγεθος
31119	S
31120	M
31121	L
31122	XL
31123	XXL
31124	XXXL

**Kapriol®**

**Παντελόνι εργασίας μπέζ**



**TENERE**

Κωδικός	Μέγεθος
28330	M
28331	L
28332	XL
28333	XXL

**Kapriol®**

**Παντελόνι εργασίας καφέ**



**NAMIB**

Κωδικός	Μέγεθος
28811	M
28814	XXL

**Kapriol®**

**Παντελόνι εργασίας μπέζ**



**NIGER**

Κωδικός	Μέγεθος
31049	S
31050	M
31051	L
31052	XL
31053	XXL

**Kapriol®**

**Παντελόνι εργασίας γκρι-μαύρο**



**NIGER**

Κωδικός	Μέγεθος
31055	S
31056	M
31057	L
31058	XL
31059	XXL
31060	XXXL

**Kapriol®**

## Παντελόνι εργασίας μπεζ-μπλε

Ελαστικό

TENERE  
PRO

Κωδικός Μέγεθος

32382 M

32383 L

32384 XL

32385 XXL

Kapriol

## Παντελόνι εργασίας γκρι-μαύρο

Ελαστικό

TENERE  
PRO

Κωδικός Μέγεθος

32375 S

32376 M

32377 L

32378 XL

32379 XXL

32380 XXXL

Kapriol

## Παντελόνι εργασίας μπλε

Ελαστικό

TENERE  
PRO

Κωδικός Μέγεθος

32394 M

32395 L

32396 XL

32397 XXL

32398 XXXL

Kapriol

## Παντελόνι εργασίας γκρι-μαύρο

Κωδικός Μέγεθος

31810 M

31811 L

31812 XL

31813 XXL

31814 XXXL

EXPERT

Kapriol

## Παντελόνι εργασίας γκρι-μαύρο

Καλοκαιρινό, ελαστικό



EXPERT LIGHT

Κωδικός Μέγεθος

31910 M

31911 L

31912 XL

31913 XXL

Kapriol

## Φόρμα εργασίας



BASIC

Κωδικός Μέγεθος

80078 L

80079 XL

80080 XXL

Kapriol

## Φόρμα εργασίας



TENERE

Κωδικός Μέγεθος

28320 M

Kapriol

## Φόρμα εργασίας οικονομική



ESSENTIAL

Κωδικός Μέγεθος

31935 M

31936 L

31937 XL

31938 XXL

Kapriol



**Μπουφάν αμάνικο μπλε**



**PYTHON**

Κωδικός	Μέγεθος
31433	XXL

**Kapriol®**

**Μπουφάν αμάνικο μαύρο**



**TECH**

Κωδικός	Μέγεθος
28886	M
28887	L
28888	XL
28889	XXL
28890	XXXL

**Kapriol®**

**Μπουφάν αμάνικο μπεζ**



**KAVIR**

Κωδικός	Μέγεθος
31500	M
31501	L
31502	XL
31503	XXL

**Kapriol®**

**Μπουφάν αμάνικο μαύρο**



**TEMPEST**

Κωδικός	Μέγεθος
28670	M
28671	L
28672	XL
28673	XXL
28674	XXXL

**Kapriol®**

**Γιλέκο εργαλειοφόρος αμάνικο μαύρο**

Με διπλή σειρά τσέπες



**SMART**

Κωδικός	Μέγεθος
31715	M
31716	L
31717	XL
31718	XXL

**Kapriol®**

**Μπουφάν αμάνικο γκρι**



**SMART**

Κωδικός	Μέγεθος
32070	M
32071	L
32072	XL
32073	XXL
32074	XXXL

**Kapriol®**

**Μπουφάν εργασίας****DRAGON**

Κωδικός	Μέγεθος
28806	L
28807	XL
28808	XXL
28809	XXXL

**Kapriol****Μπουφάν εργασίας****SMART**

Κωδικός	Μέγεθος
32261	M
32262	L
32263	XL
32264	XXL
32265	XXXL

**Kapriol****Σετ αδιάβροχα παντελόνι - σακάκι**

Διαθέσιμα σε κίτρινο και πράσινο χρώμα

**RAIN**

Κωδικός	Μέγεθος
28180	XL
28181	XXL
28182	XL
28183	XXL

**Kapriol**

**Φλις εργασίας πολυεστερικό μαύρο****WOLF****Κωδικός Μέγεθος**

28381 M

28382 L

28383 XL

28384 XXL

28385 XXXL

**Kapriol®****Φλις εργασίας πολυεστερικό ανθρακί****WOLF****Κωδικός Μέγεθος**

32300 M

32301 L

32302 XL

32303 XXL

32304 XXXL

**Kapriol®****Φλις εργασίας καφέ****Πρόκειται να καταργηθεί****BEAR****Κωδικός Μέγεθος**

31019 XXXL

**Kapriol®****Σκουφάκι πλεκτό****FROZEN****Κωδικός**

31308

**Kapriol®****Εσωθερμικό μπλουζάκι****TERMICA****Κωδικός Μέγεθος**

28790 M

28791 L

28792 XL

**Kapriol®****Εσωθερμικό παντελόνι****TERMICI****Κωδικός Μέγεθος**

28785 M

28786 L

28787 XL

**Kapriol®**

## Μάσκα προστασίας γκρι



RACING

Κωδικός  
28173

Kapriol®

## Μάσκα προστασίας διαφανής

Φοριέται και με γυαλιά οράσεως



SLALOM

Κωδικός  
28116

Kapriol®

## Γυαλιά προστασίας



COMBI

Κωδικός  
28160

Kapriol®

## Προστατευτικά γυαλιά

Κωδικός  
G17

PLANO®

## Προστατευτικά γυαλιά

Κωδικός  
G18

PLANO®

## Προστατευτικά γυαλιά

Κωδικός  
G20

PLANO®

## Προστατευτικά γυαλιά

Κωδικός  
G24

PLANO®

## Προστατευτικά γυαλιά με μεταλλικό σκελετό

Κωδικός  
G42

PLANO®



**Μάσκες κυπελοειδείς 10 τεμάχια** **NEO**

FFP2



**Κωδικός**  
32567

**Kapriol**

**Μάσκες κυπελοειδείς 3 τεμάχια** **NEO**

FFP2  
Με βαλβίδα  
εκπνοής



**Κωδικός**  
32569

**Kapriol**

**Μάσκες κυπελοειδείς 5 τεμάχια** **NEO**

FFP3  
Με βαλβίδα  
εκπνοής



**Κωδικός**  
32582

**Kapriol**

**Ωτασπίδες εργασίας 27dB**

**SILVER 27**



**Κωδικός**  
28103

**Kapriol**

**Ωτασπίδες εργασίας 24dB**

**SILVER 24**



**Κωδικός**  
28102

**Kapriol**

**Ωτασπίδες εργασίας 29dB**

**TEKNO  
COMPACT**



**Κωδικός**  
31252

**Kapriol**

**Ωτασπίδες 36dB (5 ζεύγη)** **NEO**

**CORD**



**Κωδικός**  
28111

**Kapriol**

Σύνδεσμος ασφαλείας 20kN



Κωδικός  
27990

**Kapriol**

Σύνδεσμος ασφαλείας 25kN

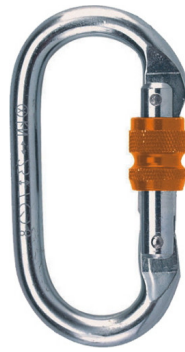

Κωδικός  
27989

**Kapriol**

Σύνδεσμος ασφαλείας 50kN



Κωδικός  
27991

**Kapriol**

Ζώνη ανάσχεσης πτώσης



**BASIC DUO**

Κωδικός  
27955

**Kapriol**

Ζώνη ανάσχεσης πτώσης



**GAMMA 2**

Κωδικός  
27973

**Kapriol**

Ζώνη θέσης



Κωδικός  
27977

**Kapriol**

Ιμάντας σύνδεσης 65 εκατοστών



Κωδικός  
27994

**Kapriol**

Ανασχετήρας ασφαλείας



Κωδικός  
27978

**Kapriol**

Διπλός αναδέτης σύνδεσης  
Με απορρόφηση έντασης



Κωδικός  
27953

**Kapriol**



**Κράνος ασφαλείας**



Κωδικός  
27999

**Kapriol**

**Προσωπίδα κράνους**



Κωδικός  
28005

**Kapriol**

**Κράνη εργοταξίου**



Κωδικός Χρώμα  
28500 Κόκκινο  
28501 Κίτρινο

**Kapriol**

**Ένθετες επιγονατίδες**



Κωδικός  
25257

**Kapriol**

**Επιγονατίδες από PVC & σιλκόνη**



Κωδικός  
25251

**Kapriol**

**Επιγονατίδες μαλακές**

Polyester - E.V.A.



Κωδικός  
KT100TB

**PLANO**

**Επιγονατίδες**

Polyester - E.V.A. - PVC



Κωδικός  
KT300TB

**PLANO**

**Επιγονατίδες με gel**

Polyester - E.V.A. - PVC - AirGel®



Κωδικός  
KT500TB

**PLANO**

## Γάντια νιτριλίου



Κωδικός	Μέγεθος
28054	8
28055	9
28056	10
28043	11

Kapriol®

## Γάντια νιτριλίου



Κωδικός	Μέγεθος
28032	9
28033	10

Kapriol®

## Γάντια νιτριλίου

Ανθεκτικά



Κωδικός	Μέγεθος
28071	9
28072	10

Kapriol®

## Γάντια νεοπρενίου



Κωδικός	Μέγεθος
28150	10

Kapriol®

## Γάντια οδήγησης



Κωδικός	Μέγεθος
28144	10
28039	11

Kapriol®

## Γάντια μεγάλης αντοχής

EN388:2016 4X44C



Κωδικός	Μέγεθος
27714	9
27715	10

Kapriol®

## Γάντια μεγάλης αντοχής

EN388:2016 2121X



Κωδικός	Μέγεθος
28044	9
28045	10

Kapriol®



### Ταμπακιέρα 6 θέσεων

Πολυπροπυλένιο



Κωδικός Διαστάσεις Βάρος  
3449 16,5x12x2,5 0,09kg

### Ταμπακιέρα 6 θέσεων

Πολυπροπυλένιο  
Ανταλλακτικό για τις εργαλειοθήκες  
652 & 682



Κωδικός Διαστάσεις Βάρος  
3452 18x12x3,5 0,14kg

### Ταμπακιέρα 4-19 θέσεων

Πολυπροπυλένιο



Κωδικός Διαστάσεις Βάρος  
3600 PRO 27,5x18x4 0,35kg

### Ταμπακιέρα 4-24 θέσεων

Πολυπροπυλένιο



Κωδικός Διαστάσεις Βάρος  
3700 PRO 35,5x23x5 0,52kg



### Ταμπακιέρα 8-30 θέσεων

Πολυπροπυλένιο



Κωδικός Διαστάσεις Βάρος  
4600 27x20x7 0,51kg



### Σετ 4 ταμπακιέρες με λαβή μεταφοράς

Πολυπροπυλένιο  
4 x 3600 PRO



Κωδικός Διαστάσεις Βάρος  
967 28x25x33 2,30kg



### Εργαλειοθήκη με 4 ταμπακιέρες

Πολυπροπυλένιο  
περιορισμένη  
διαθεσιμότητα



Κωδικός  
1364



### Θήκη υλικών

ABS



Κωδικός Βάρος  
ORGANIZER 1 2,10kg



### Θήκη υλικών

ABS



Κωδικός Βάρος  
SYSTEM 1 4,70kg



**Εργαλειοθήκη 15"**

Μεταλλικό μάνδαλο



Κωδικός	Διαστάσεις	Βάρος
351	39x21x19	1,00kg

**Εργαλειοθήκη 16"**Μεταλλικό μάνδαλο  
μαλακή λαβή

Κωδικός	Διαστάσεις	Βάρος
451	42x23x23	1,40kg

**Εργαλειοθήκη 20"**Μεταλλικά μάνδαλα  
μαλακή λαβή

Κωδικός	Διαστάσεις	Βάρος
652	51x28x29	2,30kg

**Εργαλειοθήκη 26"**Μεταλλικά μάνδαλα  
μαλακή λαβή

Κωδικός	Διαστάσεις	Βάρος
682	66x27x29	3,20kg

**Εργαλειοθήκη 17"**

Αναδιπλούμενο δίσκο



Κωδικός	Διαστάσεις	Βάρος
911	44x26x26	2,00kg

**Θήκη μεταφοράς ηλεκτρικών εργαλείων 15"**

Υποδοχή για εξαρτήματα



Κωδικός	Διαστάσεις	Βάρος
999	38x35x14,5	1,10kg





**Πολυεστρερική τσάντα εργαλείων 12"**



**Κωδικός** Διαστάσεις **Βάρος**  
513000TB 31x19x24 0,70kg



**Πολυεστρερική τσάντα εργαλείων 16"**



**Κωδικός** Διαστάσεις **Βάρος**  
513002TB 41x24x26 1,20kg



**Πολυεστρερική τσάντα εργαλείων μπανάνα**



**Κωδικός**  
545TB



**Πολυεστρερικό σακίδιο**



**Κωδικός** Διαστάσεις  
563TB 35x25x50



**Πολυεστρερικό σακίδιο**



**Κωδικός**  
542TB



**Πολυεστρερικό σακίδιο 19"**



**Κωδικός** Διαστάσεις  
513006NT 48x29x42



**Πολυεστρερικό σακίδιο 17"**



**Κωδικός** Διαστάσεις  
513013 43x23x36



**Πολυεστρερικό σακίδιο 11"**

Τροχήλατο



**Κωδικός** Διαστάσεις  
513014NR 46x26x36



**Πολυεστρερική τσάντα εργαλείων 15"**



**Κωδικός Διαστάσεις Βάρος**  
513011 38x23x30 1,90kg



**Πολυεστρερική τσάντα εργαλείων 17"**



**Κωδικός Διαστάσεις Βάρος**  
513012 42x23x27 1,70kg



**Πολυεστρερική βαλίτσα εργαλείων 19"**



**Κωδικός Διαστάσεις Βάρος**  
PC100E 48x40x17 3,60kg



**Πολυεστρερική βαλίτσα εργαλείων τρόλλευ 19"**



**Κωδικός Διαστάσεις Βάρος**  
PC120E 48x46x24 5,20kg



**Πολυεστρερική βαλίτσα εργαλείων 19"**



**Κωδικός Διαστάσεις**  
513008NT 48x32x29



**Βαλίτσα εργαλείων**



**Κωδικός**  
559TB



**Πολυεστρερική σκληρή τσάντα εργαλείων 20"**



**Κωδικός Διαστάσεις Βάρος**  
PC513004 50x25x29 2,40kg



**Βαλίτσα εργαλείων 21"**

ABS



Κωδικός	Διαστάσεις	Βάρος
PC400E	53x42x16	4,60kg

**Βαλίτσα εργαλείων 21"**

ABS



Κωδικός	Διαστάσεις	Βάρος
PC600E	53x42x20	5,70kg

**Βαλίτσα εργαλείων 21" με ρόδες**

ABS



Κωδικός	Διαστάσεις	Βάρος
PC620E	53x42x26	7,20kg

**Βαλίτσα αδιάβροχη IP67 21"**

ABS



Κωδικός	Διαστάσεις	Βάρος
PC700E	52,5X22X17cm	5,4kg

**Βαλίτσα αδιάβροχη IP67 21"**

ABS



Κωδικός	Διαστάσεις	Βάρος
PC800	52,5X22X40cm	5,9kg

**Βαλίτσα εργαλείων 20,6" με ρόδες**

ABS



Κωδικός	Διαστάσεις	Βάρος
PC720E	52,5x40x22	7,60kg

**Βαλίτσα εργαλείων 20,6" με ρόδες**

ABS



Κωδικός	Διαστάσεις	Βάρος
PC820E	52,5x40x27	8,10kg

**Μπαούλα**Πολυπροπυλένιο  
-45°~60°C

Κωδικός	Διαστάσεις ΠΒΥ	Χωρητικότητα	Βάρος
HDP60	60x48x48cm	60ℓ	5,9kg
HDP80	80x48x50cm	113ℓ	8,3kg
HDP100	100x48x50cm	160ℓ	10kg

**Πολυεστερική θήκη εργαλείων που τυλίγεται**

Κρεμίζεται

Κωδικός Βάρος  
558TB 1,10kg**Πολυεστρερικό γιλέκο εργαλείων**Κωδικός  
513010**Πολυεστρερική εργαλειοθήκη ώμου**Κωδικός  
550NT**Πολυεστρερική εργαλειοθήκη ώμου**Κωδικός  
556TB**Πολυεστρερική εργαλειοθήκη μέσης με ζώνη μεγάλης αντοχής**Κωδικός  
52200TB**Πολυεστρερική θήκη ζώνης για εργαλεία**Κωδικός  
533TB**Πολυεστρερική θήκη ζώνης για εργαλεία**Κωδικός  
534TB**Πολυεστρερική θήκη ώμου για εργαλεία**Κωδικός  
543TB



**Πολυεσθερική θήκη ζώνης για βιδολόγο**



**Κωδικός**  
531TB



**Πολυεσθερική θήκη ζώνης για εργαλεία με κλιπ για τη ζώνη**



**Κωδικός**  
522TB



**Πολυεσθερική ζώνη με κλιπ**

ενισχυμένη  
για μέση:  
90~120cm



**Κωδικός**  
530TB



**Θήκη κινητού**



**Κωδικός**  
549TB



**Θήκη κινητού τύπου Galaxy**

Poliestere - E.V.A.



**Κωδικός**  
549XLTB



**Θήκη κινητού**

Poliestere  
για μεγαλύτερα μοντέλα



**Κωδικός**  
539TB



**Θήκη για tablet**



**Κωδικός**  
562TB





513010



550NT



556TB



52200TB



530TB



522TB



531TB



533TB



534TB



543TB



549TB



549XLTB



539TB



562TB



### Θήκη ζώνης για σφυριά



Κωδικός  
25016

**Kapriol**

### Μπανάνα μέσης



Κωδικός  
25032

**Kapriol**

### Μπανάνα μέσης



Κωδικός  
25042

**Kapriol**

### Σολντερίνη



Κωδικός	Βάρος
415005	50gr
415010	100gr



### Καλάι



Κωδικός	Τύπος
30-400010-0	1,0mm 100gr 60/40
30-391010-0	1,0mm 100gr 70/30
30-400025-0	1,0mm 250gr 60/40
30-391025-0	1,0mm 250gr 70/30
30-401025-0	1,5mm 250gr 60/40
30-392025-0	1,5mm 250gr 70/30
30-402025-0	2,0mm 250gr 60/40
30-393025-0	2,0mm 250gr 70/30



### Κολλητήρι μπαταρίας

Λειτουργεί με μπαταρίες AA (δεν περιλαμβάνονται)



Κωδικός
1620



### Κολλητήρι μπαταρίας επαναφορτιζόμενο

Λειτουργεί με μπαταρία λιθίου 3,6V 2200mAh



Κωδικός
1622



### Κολλητήρια 230V



Κωδικός	Ισχύς
370003	30W



### Κολλητήρια 230V

Περιέχει 2 μύτες



Κωδικός	Ισχύς
170040	30W
170060	40W
170100	100W



### Κολλητήρια 230V

Περιέχει 2 μύτες



Κωδικός	Ισχύς
3020CD	50W
3025CD	100W



### Κολλητήρι πιστόλι 200W

Περιέχει 3 μύτες



Κωδικός
1740 PRO





### Πυρογράφος - κολλητήρι

7 διαφορετικές μύτες  
240V 20-40W  
Βάση στήριξης



Κωδικός  
1500 KIT



### Εργαλείο φελιζόλ 9W

Κόβει - Σκαλίζει



Κωδικός  
1650



### Κολλητήρια με χαβιά



Κωδικός	Ισχύς
3030N	120W
3040N	250W
3050N	320W



### Κολλητήρια με χαβιά



Κωδικός	Ισχύς
30-376040-0	400W
30-376050-0	500W
30-382750-0	Μύτη 500W



### Κολλητήρι αερίου με χαβιά



Κωδικός  
600000



### Ανταλλακτική μύτη χαβιά αερίου

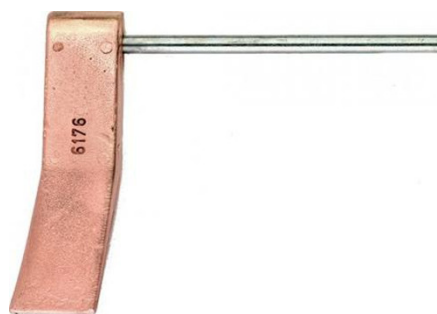

Κωδικός  
6176200



### Ανταλλακτικές μύτες πυρογράφου

6 μύτες

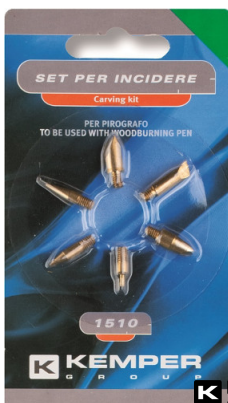

Κωδικός  
1510



### Ανταλλακτικές στάμπες πυρογράφου

7 στάμπες

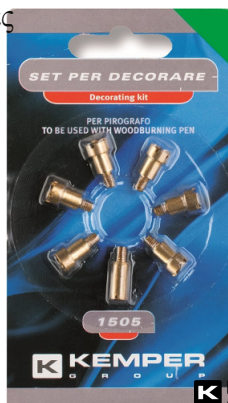

Κωδικός  
1505



### Ανταλλακτικές λεπίδες πυρογράφου

6 λεπίδες



Κωδικός  
1515



**Αντίσταση εργαλείου φελιζόλ**

Μήκος: 1 μέτρο. Πάχος 0,23 χιλιοστά.

**Κωδικός**

1651

**Σετ 5 μύτες και προσαρμογέας**

Για το φλόγιστορ στυλό 10500

**Κωδικός**

10503

**Σετ 3 ακροφύσια**

Για το φλόγιστορ στυλό 10500

**Κωδικός**

10521

**Κολλητήρι αερίου 3 σε 1**

Φλόγιστορ - Κολλητήρι - Πυρογράφος

**Κωδικός**

12100 KIT

**Κολλητήρι αερίου φλόγιστορ****Κωδικός**

12000 KIT

**Σετ 5 εξαρτήματα**

Για το φλόγιστορ βουτανίου 12000 KIT

**Κωδικός**

12101

**Σετ εξαρτήματα**

Για το φλόγιστορ βουτανίου 12500

**Κωδικός**

12501



**Μίνι φλόγιστρο βουτανίου**

Λειτουργεί με αέριο αναπτήρων.  
Στέκεται όρθιος



Κωδικός  
1048D

**Φλόγιστρο βουτανίου**

Λειτουργεί με αέριο αναπτήρων



Κωδικός  
12500

**Φλόγιστρο ζαχαροπλαστικής**

Διακόπτης ασφαλείας - Δυνατότητα  
συνεχούς λειτουργίας



Κωδικός  
13000

**Φλόγιστρα υγραερίου πλαστικό**

Κωδικός	Τύπος
KE2018	Απλό μπλε
KE2019	Πιεζοηλεκτρικό

**Φλόγιστρο υγραερίου πλαστικό**

Κωδικός	Τύπος
505000	Απλό

**Φλόγιστρο με 3 ακροφύσια Ø14 Ø18 Ø22**

Κωδικός  
601050

**Φλόγιστρο με 3 ακροφύσια Ø20 Ø30 Ø45**

Κωδικός  
1217 KIT

**Φλόγιστρο χειρός μακρύ με πάσο  $\frac{7}{16}$ "**

Με πιεζοηλεκτρική ανάφλεξη και φιάλη αερίου.  
Για κάψιμο χόρτων σε δύσκολα σημεία,  
γρήγορο άναμμα τζακιού, bbq κλπ.



Κωδικός  
1047GBPC

**Φλόγιστρα μακριά**

Ρυθμιζόμενα με σκανδάλη

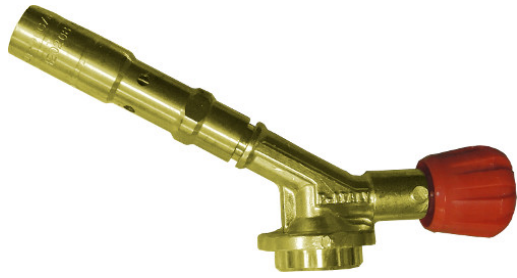

Κωδικός	Τύπος
121945M	Ø45mm 63cm
121960L	Ø60mm 86cm

**Φλόγιστρο προπανίου - βουτανίου**

**Κωδικός**  
572592

**Αντάπτορας από CGA600 σε 7/16"**

Για σύνδεση φλόγιστρων τύπου MAPP-PRO σε φιάλες αερίου με πάσο 7/16"



**Κωδικός**  
490280

**Αντάπτορας ΑΡΣ 7/16" ΘΗΛΑ CGA600**

**Κωδικός**  
583

**Αντάπτορας ΘΗΛΑ 7/16" ΑΡΣ CGA600**

**Κωδικός**  
584

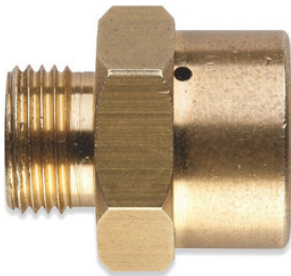
**Αντάπτορας M10X1 σε M12X1**

**Κωδικός**  
588B

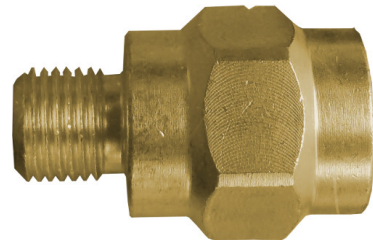
**Αντάπτορας M12X1 σε M10X1**

**Κωδικός**  
589B

**Φιάλη MAPP GAS 400 γραμμαρίων**

Πάσο CGA600



**Κωδικός**  
SEH024600

**SUPER-EGO**

### Φορητή οξυγονοκόλληση Set30

Με φιάλη οξυγόνου και φιάλη προπανίου - βουτανίου  
 $\leq 2850^{\circ}\text{C}$



Κωδικός  
117050



### Φορητή οξυγονοκόλληση Set90

Με φιάλη οξυγόνου και φιάλη προπανίου MAXI GAS  
 $\leq 3000^{\circ}\text{C}$



Κωδικός  
115050



### Φορητή οξυγονοκόλληση Set110

Με φιάλη οξυγόνου και φιάλη προπανίου MAPP GAS  
 $\leq 3050^{\circ}\text{C}$



Κωδικός  
131090.MP



### Φορητή οξυγονοκόλληση Set200

Με φιάλη οξυγόνου και φιάλη προπανίου MAPP GAS  
 $\leq 3100^{\circ}\text{C}$



Κωδικός  
111010



### Φιάλη Οξυγόνου

Πάσο M12X1  
 (δεξιόστροφο)



Κωδικός  
480300



### Φιάλη προπανίου-βουτανίου

330γρ.  
 Πάσο  $\frac{7}{16}$ "  
 αρσ.



Κωδικός  
483150



### Φιάλη προπανίου-βουτανίου

SUPERGAS  
 600ml  
 Πάσο  $\frac{7}{16}$ "  
 αρσ.



Κωδικός  
575



### Φιάλη προπανίου

350γρ MAXI GAS  
 Πάσο  $\frac{7}{16}$ "  
 αρσ.



Κωδικός  
483200



### Μπρουντζοκόλληση σε ράβδους

10 τεμάχια

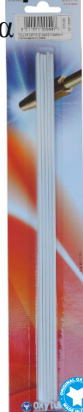

Κωδικός  
101500



### Χαλκοκόλληση σε ράβδους

10 τεμάχια

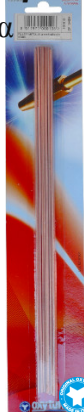

Κωδικός  
101510



### Μολυβδοκόλληση σε ράβδους

2 τεμάχια



Κωδικός  
101590



### Λάμπα οξυγόνου - προπανίου

Για το Set90. Πάσο M12X1 δεξιόστροφο



Κωδικός  
110000



### Μειωτήρες με μανόμετρα

Κωδικός	Τύπος
260253	Οξυγόνου
260550	Οξυγόνου Ασετιλίνης
261250	Ασετιλίνης
265500	Argon
262350	Προπανίου
264250	Αζώτου



### Παγίδα φλόγας για σωλήνες οξυγόνου



Κωδικός  
150210



### Παγίδα φλόγας για σωλήνες αερίου



Κωδικός  
150190



### Μειωτήρας προπανίου με μανόμετρο



Κωδικός  
282500



### Ρυθμιστής οξυγόνου 7/16"



Κωδικός  
260553



### Ρυθμιστής αερίου για το Set90

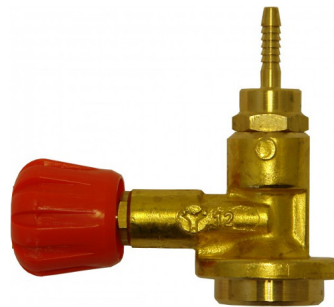

Κωδικός  
201500



### Ρυθμιστής οξυγόνου M12X1 δεξιόστροφος



Κωδικός  
220500

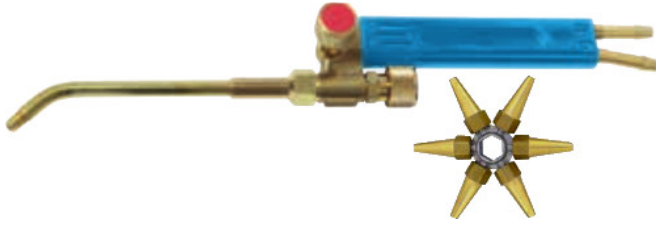

**Λαβή οξυγονοκόλλησης (λάμπα) 400l/h**G400  
Με 6 μπεκ

Κωδικός	Τύπος
038790	Ø6,3mm 330mm 320gr

**Λαβή οξυγονοκόλλησης (λάμπα) 1000l/h**G1000  
Με 6 μπεκ

Κωδικός	Τύπος
038868	Ø10mm 460mm 770gr

**Πυροκόφτης υψηλής πίεσης**

HG1 Shielded



Κωδικός	Τύπος
038783	90° Ø10 470mm 1270gr

**Μπεκ κοπής με ασετιλίνη**

G1



Κωδικός	Τύπος
038899	7/10
038905	10/10
038912	12/10
038929	16/10
038936	20/10

**Μπεκ κοπής με προπάνιο**

G1



Κωδικός	Τύπος
038943	7/10
038950	10/10
038967	12/10
038974	16/10
038981	20/10



### Γκαζάκι υγραερίου



Κωδικός  
KE2009



### Φιάλη βουτανίου 150ml



Κωδικός  
10051



### Αναπτήρες BBQ

Κόκκινο Μπλε Πορτοκαλί Γκρι



Κωδικός  
1049D



### Αναπτήρες BBQ σπαστοί

Κόκκινο Μπλε Κίτρινο Μαύρο



Κωδικός  
1049DF



### Πλεκτά σχοινιά

Κωδικός	Πάχος
EVI-03	3mm
EVI-04	4mm
EVI-05	5mm
EVI-06	6mm
EVI-08	8mm
EVI-10	10mm
EVI-12	12mm
EVI-14	14mm
EVI-16	16mm
EVI-18	18mm
EVI-20	20mm



### Σχοινιά μαύρα

Κωδικός	Πάχος
EVI-M03	3mm
EVI-M04	4mm
EVI-M05	5mm
EVI-M06	6mm
EVI-M08	8mm
EVI-M10	10mm



### Καννάβινα σχοινιά

Κωδικός	Πάχος
EV-K06	6mm
EV-K08	8mm
EV-K10	10mm
EV-K12	12mm
EV-K14	14mm
EV-K16	16mm
EV-K20	20mm
EV-K22	22mm



### Ελαστικά σχοινιά

Έγχρωμα	
Κωδικός	Πάχος
EV-L04C	4mm
EV-L05C	5mm
EV-L06C	6mm
EV-L08C	8mm
Μαύρα	
Κωδικός	Πάχος
EVI-L04	4mm
EVI-L05	5mm
EVI-L06	6mm
EVI-L08	8mm
EVI-L10	10mm





### Σχοινιά συσκευασία

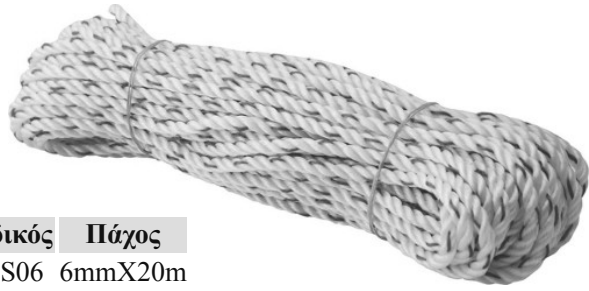

Κωδικός	Πάχος
EV-S06	6mmX20m
EV-S08	8mmX15m

### Ιμάντας πρόσδεσης



Κωδικός	Τύπος
LC750KG	25mmX4,5m 750kg

### Ιμάντες ανύψωσης φορτίων 50X3,8mm

Φορτίο: ≤800 κιλά BS50380010 - BS5038100

Μήκος	Μήκος
3m	6m
3,5m	7m
4m	8m
4,5m	9m
5m	10m



TAIWAN

### Ιμάντες ανύψωσης φορτίων 50X7,6mm

Φορτίο: ≤2 τόνοι BD50760010 - BD5076100

Μήκος	Μήκος
1m	4,5m
1,5m	5m
2m	6m
2,5m	7m
3m	8m
3,5m	9m
4m	10m



TAIWAN

### Ιμάντες πρόσδεσης φορτίων

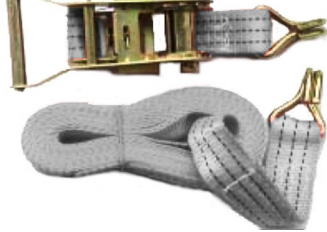

Κωδικός	Διαστάσεις	Φορτίο
RLS03060	38mmX6 μέτρα	3 τόνοι

TAIWAN

### Ιμάντες πρόσδεσης φορτίων



με μονό γάντζο

Κωδικός	Διαστάσεις	Φορτίο
509500	50mmX9 μέτρα	5 τόνοι

TAIWAN

### Ιμάντες πρόσδεσης φορτίων



με διπλό γάντζο

Κωδικός	Διαστάσεις	Φορτίο
509501	50mmX9 μέτρα	5 τόνοι

TAIWAN

### Βίντσια (εργάτες) NEO

EN 13157

Αποσπώμενη μανιβέλα  
Αντοχή σε αλμύρα



Κωδικός	Τύπος			Δύναμη	Μήκος ανά περιστροφή	Βάση
1225300	450kg με φρένο	4,5kg	6m	220N	4,5-10cm	140*92mm
1225547	500kg	4kg	7m	200N	3,7-9cm	140*92mm
1225303	900kg	8kg	7m	230N	2,5-6,3cm	170*118mm

**AL-KO**  
QUALITY FOR LIFE

**Φακός πολυεργαλείο**

**Κωδικός**  
IN252

**Φακός τηλεσκοπικός με 3 led**

**Κωδικός**  
IF05.012E

**Φακός πλακέ με led 0,6W**

Ρυθμιζόμενος. Με γάντζο και ορθοστάτη



**Κωδικός**  
D63LED

**Φακός στυλό με 8 led**

Με γάντζο και μαγνήτη



**Κωδικός**  
DL401.012E





Σετ ξυλογλυπτικής



**Κωδικός** **Τύπος**  
1285-001 5 τεμαχίων

**TopMan**

Σετ ξυλογλυπτικής



**Κωδικός** **Τύπος**  
1278-006 6 τεμαχίων

**TopMan**

Σκαρπέλα Ιαπωνίας **NEO**

Ανθρακούχο ατσάλι  
Μεγάλη αντίσταση σε κρούσεις



**Κωδικός** **Τύπος**  
EN-015BP 9mm  
EN-02BP 12mm  
EN-025BP 15mm  
EN-03BP 19mm  
EN-035BP 22mm

**KDS**

Ακονόπετρα

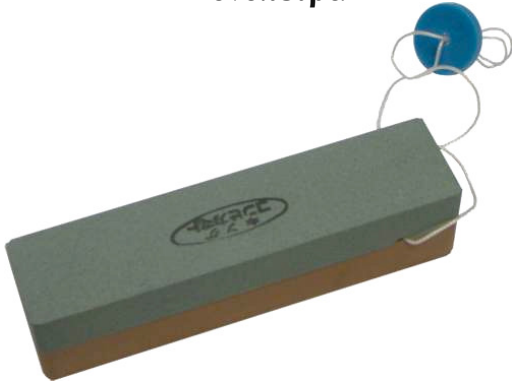

**Κωδικός** **Τύπος**  
3838-002 Grit 250/1000

**TopMan**

Ιαπωνική ακονόπετρα νερού

176x52x15mm



**Κωδικός** **Τύπος**  
3839-005 Grit 4000

**TopMan**

Ιαπωνική ακονόπετρα νερού

185x63x25mm



**Κωδικός** **Τύπος**  
K-PB-04 Grit 800/6000

**TopMan**

Ιαπωνική ακονόπετρα νερού

210x73x22mm



**Κωδικός** **Τύπος**  
3854-011 Grit 8000

**TopMan**

**Κατσαβίδια Z ίσια**  
4X100mm



Κωδικός  
22-177010-0



**Κατσαβίδια Z ίσια**  
5,5X125mm



Κωδικός  
22-177012-0



**Κατσαβίδια Z PH1 & PH2**



Κωδικός  
22-178010-0



**Δοκιμαστικό κατσαβίδι**  
3X65mm



Κωδικός  
240902001



**Tester οχημάτων** **NEO**



Κωδικός Τύπος  
88427 3-48Vdc



**Δοκιμαστικό αυτοκινήτων**  
6-24V



Κωδικός  
36910



**Κατσαβίδια Wittron ίσια**



Κωδικός	Τύπος
89712	1X40mm
89714	1,5X40mm
89716	2X60mm
89717	2,5X75mm



**Κατσαβίδια Wittron Phillips**



Κωδικός	Τύπος
89731	PH000X40mm
89732	PH00X40mm
89733	PH0X60mm
89734	PH1X80mm



**Κατσαβίδια Wittron Torx**



Κωδικός	Τύπος
89751	T5X50mm
89752	T6X50mm
89753	T7X50mm
89754	T8X60mm



**Σετ κατσαβίδι ηλεκτρονικών** **NEO**

Σε πορτοφόλι

- ⊖ 0,25x1,5 - 0,5x3
- 0,4x2 - 0,6x3,5
- 0,4x2,5 - 0,8x4
- ⊕ #000 - #00
- #0 - #1

Κωδικός Τύπος  
99-0106 1/8"



**Σετ 8 μίνι κατσαβιδιών χρυσοχού**

⊖ ⊕

Ίσια: 2-2,5-3-3,5-4mm  
PH00-PH0-PH1  
Μήκος άξονα 75mm



Κωδικός Τύπος  
2087A 233mm



**Σετ κατσαβίδια ηλεκτρονικών Torx με τρύπα**

Κασετίνα

- ⊕ T-5H, T-6H, T-7H, T-8H 40mm
- ⊕ T-9H, T-10H, T-15H, T-20H 75mm

Κωδικός  
2088AT



**Κατσαβίδια χούφτας ίσια**

Μήκος άξονα: 25mm



Κωδικός	Τύπος
713055S	1X5,5mm
713065S	1,2X6,5mm

**FORCE****Κατσαβίδια ίσια**

Κωδικός	Τύπος	Κωδικός	Τύπος
87301	3,5X75mm	87307	6,5X125mm
87303	4X75mm	87309	8X150mm
87304	4X100mm	87310	8X175mm
87305	5,5X100mm		
87306	5,5X125mm		

**WITTE**  
WERKZEUGE**Κατσαβίδι ίσιο μακρύ**

4X300mm



Κωδικός
86894

**WITTE**  
WERKZEUGE**Κατσαβίδια ίσια INOX**

Κωδικός	Τύπος	Κωδικός	Τύπος
73021	3X75mm	73024	5,5X125mm
73023	4X100mm	73025	6,5X150mm

**WITTE**  
WERKZEUGE**Κατσαβίδια ίσια**

Κωδικός	Τύπος	Κωδικός	Τύπος
71303	0,5X3mm	713055	1X5,5mm
713035	0,5X3,5mm	713065	1,2X6,5mm
71304	0,8X4mm		

**FORCE****Κατσαβίδια ίσια**

Με εξάγωνο για υποβοήθηση.



Κωδικός	Τύπος
71308	1,2X8mm

**FORCE****Κατσαβίδια ίσια 1000V**

VDE Maxpro



Κωδικός	Τύπος
53702	3X100mm
53704	4X100mm
53705	5,5X125mm
53706	6,5X150mm

**WITTE**  
WERKZEUGE**Κατσαβίδια ίσια 1000V**

VDE Protop II



Κωδικός	Τύπος
74054	4X100mm

**WITTE**  
WERKZEUGE**Σταυροκατσαβίδια Phillips Modul 1000V**

Κωδικός	Τύπος	Τύπος
74082	PH1X80mm	PRO VDE
53741	PH1X80mm	VDE Maxpro
53742	PH2X100mm	VDE Maxpro

**WITTE**  
WERKZEUGE**Κατσαβίδι Pozidrive 1000V**

PRO VDE



Κωδικός	Τύπος
74073	PZ2X100

**WITTE**  
WERKZEUGE**Κατσαβίδια ίσια μακριά 300mm**

Κωδικός	Τύπος
655304	4mm
655305	5mm

**FORCE****Κατσαβίδια Phillips μακριά 350mm**

Κωδικός	Τύπος
65511	PH1
65512	PH2

**FORCE**

## Σταυροκατσάβιδα χούφτας Phillips



Μήκος άξονα: 25mm



Κωδικός Τύπος

7111S PH1

7112S PH2



## Σταυροκατσάβιδα Phillips



Κωδικός Τύπος

94901 PH0X60mm

94902 PH1X80mm

94904 PH2X100mm

94906 PH3X150mm



## Σταυροκατσάβιδα Phillips μακριά



Κωδικός Τύπος

94903 PH1X300mm

94905 PH2X300mm



## Σταυροκατσάβιδα Phillips INOX



Κωδικός Τύπος

73032 PH1X80mm

73035 PH2X100mm

73038 PH3X150mm



## Σταυροκατσάβιδα Phillips



Κωδικός Τύπος Κορμός

7110 PH0 60mm

7111 PH1 80mm

7112 PH2 100mm

7113 PH3 150mm



## Σταυροκατσάβιδα Phillips 1000V



VDE Maxpro



Κωδικός Τύπος

53710 PH0X60mm

53711 PH1X80mm



## Σταυροκατσάβιδα Pozidrive



Κωδικός Τύπος

99702 PZ1X80mm

99704 PZ2X100mm

99706 PZ3X150mm



## Σταυροκατσάβιδα Pozidrive



Με εξάγωνο



Κωδικός Τύπος

99901 PZ1X80mm

99902 PZ2X100mm



## Σταυροκατσάβιδα Posidrive INOX



Κωδικός Τύπος

73042 PZ1X80mm

73045 PZ2X100mm

73048 PZ3X150mm



## Σταυροκατσάβιδα Pozidrive



Κωδικός Τύπος Κορμός

7121 PZ1 80mm

7122 PZ2 100mm

7123 PZ3 150mm



## Κατσαβίδια allen μπίλιας



## Κωδικός Τύπος

350-0150	1,5mm
350-0200	2mm
350-0250	2,5mm
350-0300	3mm
350-0400	4mm
350-0500	5mm
350-0600	6mm
350-0800	8mm
350-1000	10mm

ARNDT

## Κατσαβίδια allen μπίλιας



## Κωδικός Μέγεθος

71502	2mm
715025	2,5mm
71503	3mm
71504	4mm
71505	5mm
71506	6mm
71508	8mm

FORCE

## Κατσαβίδια Torx



## Κωδικός Τύπος

99004	T8X60
99005	T9X60
99006	T10X80
99007	T15X80
99008	T20X100
99009	T25X100
99010	T27X115
99011	T30X115
99012	T40X115

WITTE  
WERKZEUGE

## Κατσαβίδια Torx INOX



## Κωδικός Τύπος

73206	T10X80mm
73207	T15X80mm
73208	T20X100mm
73209	T25X100mm
73211	T30X115mm
73212	T40X115mm

WITTE  
WERKZEUGE

## Κατσαβίδια Torx μακριά



## Κωδικός Τύπος Κορμός Μήκος

71630010	T10	300mm	405mm
71630015	T15	300mm	405mm
71630020	T20	300mm	405mm
71630025	T25	300mm	405mm
71630027	T27	300mm	415mm
71630030	T30	300mm	415mm

FORCE

## Κατσαβίδια Torx με τρύπα



## Κωδικός Τύπος Κορμός Κωδικός Τύπος Κορμός

71705	TT5	60mm	71720	TT20	100mm
71706	TT6	60mm	71725	TT25	100mm
71707	TT7	60mm	71727	TT27	115mm
71708	TT8	60mm	71730	TT30	115mm
71709	TT9	60mm	71740	TT40	130mm
71710	TT10	80mm	71745	TT45	130mm
71715	TT15	80mm			

FORCE

## Κατσαβίδια Tri-wing



## Κωδικός Τύπος

53072	3X100mm
-------	---------

WITTE  
WERKZEUGE

## Κατσαβίδια τετράγωνα NEO

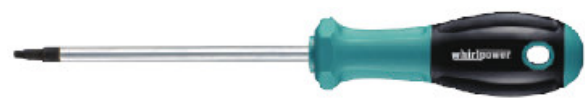

## Κωδικός Τύπος

S119-1-1001	SQ1x100
S119-1-1252	SQ2x125
S119-1-1503	SQ3x150

whirlpower.  
The Original.

## Κατσαβίδια καρυδάκια



Κωδικός	Τύπος
99505	5,5X100mm
99506	6X125mm
99507	7X125mm
99508	8X125mm
99510	10X125mm
99511	11X125mm
99512	12X125mm
99513	13X125mm

## Κατσαβίδια καρυδάκια



Κωδικός	Τύπος	Κωδικός	Τύπος
74425004	4mm	74425009	9mm
744250045	4,5mm	74425010	10mm
74425005	5mm	74425011	11mm
744250055	5,5mm	74425012	12mm
74425006	6mm	74425013	13mm
74425007	7mm	74425014	14mm
74425008	8mm		

## Κατσαβιδολαβή για καρυδάκια 1/4" εύκαμπτη



Κωδικός	Μήκος
6481.4	160mm
8113	275mm

## Κατσαβίδια καρυδάκια με εύκαμπτο σπирάλ μήκος 270 χιλιοστά



Κωδικός	Τύπος
64806	6mm
64807	7mm
64808	8mm

## Κατσαβίδι καρυδάκι με εύκαμπτο σπирάλ μήκος 270 χιλιοστά



Κωδικός	Τύπος
6480607	6mm - 7mm

## Κατσαβίδι για μύτες 1/4"



Κωδικός
8144

## Σειρά κατσαβιδιών

- Maxpro
- ⊕RH1X80
- ⊕RH2X100
- ⊖4X75
- ⊖5,5X100
- ⊖6,5X125



Κωδικός
670069

## Σειρά 6 κατσαβιδιών 1000V

- PRO VDE
- ⊕RH1X80
- ⊕RH2X100
- ⊖3X100
- ⊖4X100
- ⊖5,5X125
- ⊖6,5X150

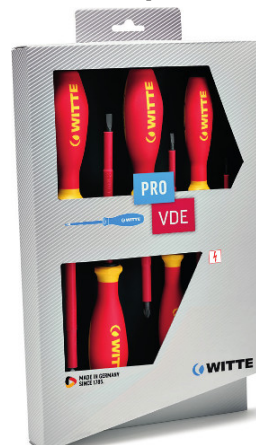

Κωδικός
670027200



## Allen με πλαστική λαβή

WITTE  
WERKZEUGE

Κωδικός	Τύπος
81102	2X100
81125	2,5X100
81103	3X150
81104	4X150
81105	5X200
81106	6X200
81108	8X200

## Ταφ Torx με πλαστική λαβή

WITTE  
WERKZEUGE

Κωδικός	Τύπος
81409	T9X100
81410	T10X100
81415	T15X100
81420	T20X100
81425	T25X110
81427	T27X110
81430	T30X130
81440	T40X130

## Ταφ Allen



FORCE

Κωδικός	Τύπος
76402T	2mm
764025T	2,5mm
76403T	3mm
764035T	3,5mm
76404T	4mm
764045T	4,5mm
76405T	5mm
76406T	6mm
76407T	7mm
76408T	8mm

Κλειδιά ταφ allen μπίλιας **NEO**

Με πλαστική λαβή



FORCE

Κωδικός	Τύπος
76502G	2mm
765025G	2,5mm
76503G	3mm
76504G	4mm
76505G	5mm
76506G	6mm
76508G	8mm

Κλειδιά ταφ torx **NEO**

Με πλαστική λαβή

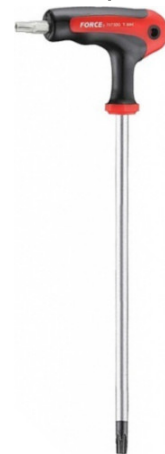

FORCE

Κωδικός	Τύπος
76710G	T10
76715G	T15
76720G	T20
76725G	T25
76727G	T27
76730G	T30
76740G	T40

## Ταφ σταθερά καρδιάκια



FORCE

Κωδικός	Τύπος
77407B	7mm
77408B	8mm
77410B	10mm
77412B	12mm
77413B	13mm

## Ταφ σπαστά καρδιάκια



FORCE

Κωδικός	Τύπος	Κωδικός	Τύπος
784206U	6mm	784315U	15mm
784207U	7mm	784316U	16mm
784208U	8mm	784317U	17mm
784209U	9mm	784418U	18mm
784310U	10mm	784419U	19mm
784311U	11mm	784420U	20mm
784312U	12mm	784421U	21mm
784313U	13mm	784422U	22mm
784314U	14mm	784424U	24mm

## Καρδιάκια μπουζί Ταφ



FORCE

Κωδικός	Τύπος
807330016UM	16mm
807330020.6UM	20,6mm

## Καρδιάκια Ταφ

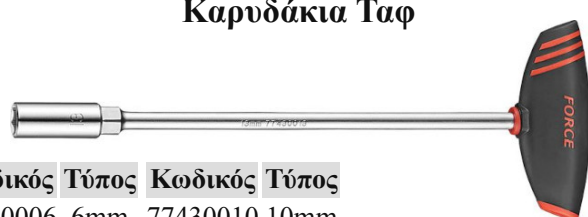

FORCE

Κωδικός	Τύπος	Κωδικός	Τύπος
77430006	6mm	77430010	10mm
77430007	7mm	77430011	11mm
77430008	8mm	77430012	12mm
77430009	9mm	77430013	13mm

### Μολύβια **NEO**

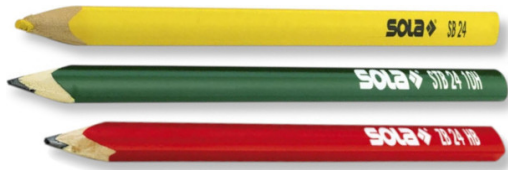

Κωδικός	Τύπος
STB 24	Οικοδόμου
ZB 24	Ξυλουργού
SB 24	Σήμανσης φωσφορούχο



### Μαρκαδόροι ανεξίτηλοι

MARKER PEN  
Πορτοκαλί, Ασημί,  
Γαλάζιο, Λευκό,  
Μπλε, Κίτρινο,  
Μαύρο, Χρυσό,  
Ροζ, Κόκκινο,  
Πράσινο, Μωβ



Κωδικός  
66610/MIX



### Σημαδευτήρι γωνιακό



Κωδικός  
47051

**ARNDT**

### Σημαδευτήρι ίσιο



Κωδικός  
25-176014-9



### Κατσαβίδι προκοβγάλης



Κωδικός  
2366

**ARNDT**

### Εργαλείο εξαγωγής κλίπ αυτοκινήτων **NEO**

Δίχαλο



Κωδικός Τύπος  
905M2P1 240mm



### Σετ εργαλείων ανοίγματος καλυμμάτων αυτοκινήτου



Κωδικός Τύπος  
905M1 5 τεμάχια



### Σετ άγκιστρα



Κωδικός Τύπος  
904U4



### Σουβλί 6X100



Κωδικός  
92500



**Μύτες Phillips 25mm**

Κωδικός	Τύπος
27020	PH1X25
27021	PH2X25
27022	PH3X25

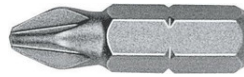
**Μύτες Pozidrive 25mm**

Κωδικός	Τύπος
27045	PZ1X25
27046	PZ2X25
27047	PZ3X25

**Μύτες Τετράγωνες 25mm**

Κωδικός	Τύπος
27091	SQ1X25
27092	SQ2X25
27093	SQ3X25

**Μύτες Phillips 25mm INOX**

Κωδικός	Τύπος
427711	PH1X25
427712	PH2X25
427713	PH3X25

**Μύτες Pozidrive 25mm INOX**

Κωδικός	Τύπος
427721	PZ1X25
427722	PZ2X25
427723	PZ3X25

**Μύτες τιτανίου Phillips με λαιμό**

Κωδικός	Τύπος
492701	PH1X25
492702	PH2X25
492703	PH3X25

**Μύτες τιτανίου Pozidrive με λαιμό**

Κωδικός	Τύπος
492704	PZ1X25
492705	PZ2X25
492706	PZ3X25

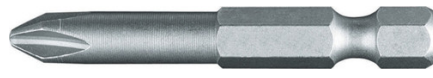
**Μύτες Phillips 50mm**

Κωδικός	Τύπος
27520	PH1X50
27521	PH2X50
27522	PH3X50

**Μύτες Pozidrive 50mm**

Κωδικός	Τύπος
27545	PZ1X50
27546	PZ2X50
27547	PZ3X50

**Μύτες Phillips Τιτανίου 50mm**

Κωδικός	Τύπος
492752	PH1X50
492753	PH2X50
492754	PH3X50

**Μύτες Phillips πολύ μακριές**

Κωδικός	Τύπος
27450	PH1X70
27451	PH1X90
27455	PH2X70
27456	PH2X90
27460	PH3X70
27461	PH3X90

**Μύτες Pozidrive πολύ μακριές**

Κωδικός	Τύπος
27560	PZ1X70
27565	PZ2X70
27570	PZ3X70
27561	PZ1X90
27566	PZ2X90
27571	PZ3X90

**Μύτες Pozidrive Τιτανίου 50mm**

Κωδικός	Τύπος
492755	PZ1X50
492756	PZ2X50
492757	PZ3X50

**Μύτες Τετράγωνες 50mm**

Κωδικός	Τύπος
27591	SQ1X50
27592	SQ2X50
27593	SQ3X50

**Μύτες Torx πολύ μακριές**

Κωδικός	Τύπος
29676	T30X70
29677	T40X70
29686	T30X90
29687	T40X90



## Μύτες Torx 25mm

DIN3126



Κωδικός	Τύπος	Κωδικός	Τύπος
29459	T4X25	429504	T15X25
29460	T5X25	429505	T20X25
27490	T6X25	429506	T25X25
27495	T7X25	429507	T27X25
429501	T8X25	429508	T30X25
429502	T9X25	429509	T40X25
429503	T10X25		

## Μύτες Torx 25mm INOX



Κωδικός	Τύπος
427730	T10X25
427731	T15X25
427732	T20X25
427733	T25X25
427734	T27X25
427735	T30X25
427736	T40X25

## Μύτες Torx 50mm



Κωδικός	Τύπος
429603	T10X50
429604	T15X50
429605	T20X50
429606	T25X50
429607	T27X50
429608	T30X50
429609	T40X50

## Μύτες Πολύσφηνο 25mm



Κωδικός	Τύπος
27414	4X25
27415	5X25
27416	6X25
27418	8X25

## Μύτες Allen 25mm

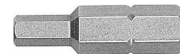

Κωδικός	Τύπος
27080	1,5X25
27081	2X25
27082	2,5X25
27083	3X25
27084	4X25
27085	5X25
27086	6X25
27087	8X25

## Μύτες Allen 50mm



Κωδικός	Τύπος
27193	3X50
27194	4X50
27195	5X50
27196	6X50
27197	8X50

## Μύτες παλμικού Phillips



Κωδικός	Τύπος
28520	PH1X38
28521	PH2X38
28522	PH3X38

## Μύτες παλμικού Pozidrive



Κωδικός	Τύπος
28523	PZ1X38
28524	PZ2X38
28525	PZ3X38

## Μύτες παλμικού Torx



Κωδικός	Τύπος
28490	T15X38
28491	T20X38
28492	T25X38
28493	T30X38
28494	T40X38

Μύτες βιδολόγου με κολλάρο γυψοσανίδας **NEO**

2 τεμάχια

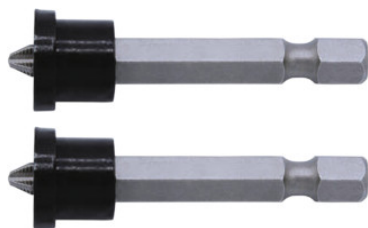

Κωδικός	Τύπος
967-23-3-0502	PH2x50mm

Καρυδάκια βιδολόγου μαγνητικά εξάγωνα **NEO**

Κωδικός	Τύπος
967-22-2-06508	8mm
967-22-2-06510	10mm
967-22-2-06513	13mm

## Μύτες σετ 7 τεμαχίων

PH1  
PH2  
PZ1  
PZ2  
0,8X5,5  
1,2X6,5



Κωδικός  
27623

**WITTE**  
WERKZEUGE

## 32 μύτες καταβιδιών και μαγνητικός προσαρμογέας



Fish eye 4,6,8,10mm  
Torq 6,8,10mm  
Tri-wing #1,#2,#3,#4  
Torx με τρύπα T8,T10,T15,T20,  
T25,T27,T30,T35,T40  
Άλλεν 2,2,5,3,4,5,6,5/32",  
9/64",1/8",7/64",3/32",5/64"



Κωδικός Τύπος  
2331A 1/4"

**FORCE**

## Σετ 30 μύτες καταβιδιών

και μαγνητικός προσαρμογέας  
Ίσιες 3-4-5-6,5mm  
Phillips PH0-PH1-PH2-PH3  
Pozidriv PZ0-PZ1-PZ2-PZ3  
Άλλεν 2-2,5-3-4-5-6mm  
Torx TT10-TT15-TT20-  
TT25-TT27-TT30-TT40



Κωδικός Τύπος  
2311 1/4"

**FORCE**

## Μύτες σετ 11 τεμαχίων INOX

**Torx:**  
T10-T40  
**Phillips:**  
2XPH2  
**Pozidriv:**  
2XPZ2



Κωδικός  
28451

**WITTE**  
WERKZEUGE

## Μύτες παλμικών σετ 10 τεμαχίων

**Torx:**  
T15-T30  
**Phillips:**  
PH1-PH3  
**Pozidriv:**  
PZ1-PZ3



Κωδικός  
28477

**WITTE**  
WERKZEUGE

## Μύτες σετ 11 τεμαχίων

**Phillips:**  
PH1-PH3  
**Pozidriv:**  
PZ1-PZ3  
**Ίσιες:**  
5,5X0,8  
6,5X1,2



Κωδικός  
28455

**WITTE**  
WERKZEUGE

## Κασετίνα με 38 μύτες Allen, Torx, Spline

- 4-5-6-7-8-10-12 mm (μήκος 30mm)
  - 4-5-6-7-8-10-12 mm (μήκος 75mm)
  - T20-T25-T30-T40-T45-T50;T55 (μήκος 30mm)
  - T20-T25-T30-T40-T45-T50-T55 (μήκος 75mm)
  - M5-M6-M8-M10-M12 (μήκος 30mm)
  - M5-M6-M8-M10-M12 (μήκος 75mm)
- και αντάπτορες για 1/4" & 3/8"

Κωδικός  
4401



**FORCE**

**Μύτες σετ 8 τεμαχίων με γωνιακή λαβή**

Κωδικός	Τύπος
2081A	PH1&2 PZ1&2 ίσιες 4&7mm
2081	Torx T10-15-20-25-27-30-40

**Μίνι κασάνια με μύτες και καρυδάκια σετ**

Ίσιες 4-5,5-6,5mm  
 Phillips PH1-PH2-PH3  
 Hex 3-4-5-6mm  
 Torx T10-T15-T20-T25-T30  
 Καρυδάκια  
 6-7-8-10-13mm



Κωδικός	Τύπος
2222	22 τεμάχια

**Ταφ με κασάνια NEO**

Για εξάγωνα μύτες 1/4"  
 Αντοχή: 48Nm



Κωδικός	Τύπος
1517-7-1414	112mm

**Βιδολόγος σπαστός με κασάνια και μύτες NEO**

- 5,5mm 6,5mm
- #1, #2
- #1, #2
- T15, T20, T25
- 4mm, 5mm, 6mm



Κωδικός	Τύπος
96-4414	60mm

**Τσοκ βιδολόγου εξάγωνο 1/4" NEO**

Κωδικός	Τύπος
969-5-06314	1-6mm

**Μαγνητικός αντάπτορας**

SDS Plus

Κωδικός  
264001**Μαγνητικός αντάπτορας**Κωδικός  
28310**Μαγνητικός αντάπτορας**

1/4"X60

Κωδικός  
81260**Μαγνητικός αντάπτορας**Κωδικός Τύπος  
81260Q 60mm  
81280Q 75mm**Αντάπτορας βιδολόγων για  
καρυδάκια 1/4"**Κωδικός  
8092250**Μαγνητική προέκταση  
βιδολόγου 1/4" 175mm**Κωδικός  
812175**Μύτες Phillips για καστίνα 1/4"**Κωδικός Τύπος  
321321 PH1  
321322 PH2  
321323 PH3**Μύτες ίσιες για καστίνα 1/4"**Κωδικός Τύπος  
3233204 4mm  
32332055 5,5mm  
32332065 6,5mm**Μύτες allen 30mm NEO**

Εξάγωνο καρέ 10mm

Κωδικός	Τύπος	Κωδικός	Τύπος
1743004	4mm	1743010	10mm
1743005	5mm	1743012	12mm
1743006	6mm	1743014	14mm
1743008	8mm		

**Μύτες allen μακριές 75mm NEO**

Εξάγωνο καρέ 10mm

Κωδικός	Τύπος	Κωδικός	Τύπος
1747504	4mm	1747508	8mm
1747505	5mm	1747510	10mm
1747506	6mm	1747512	12mm

**Μύτες torx 30mm NEO**

Εξάγωνο καρέ 10mm

Κωδικός	Τύπος	Κωδικός	Τύπος
1763020	T20	1763040	T40
1763025	T25	1763045	T45
1763027	T27	1763050	T50
1763030	T30	1763055	T55
1763035	T35	1763060	T60

**Μύτες torx 75mm NEO**

Εξάγωνο καρέ 10mm

Κωδικός	Τύπος	Κωδικός	Τύπος
1767520	T20	1767545	T45
1767525	T25	1767550	T50
1767530	T30	1767555	T55
1767535	T35	1767560	T60
1767540	T40		



**Πενσάκι**

**Κωδικός Μήκος**  
0805110 110mm

**Πένσες**

**Κωδικός Μήκος**  
0202180 180mm  
0202200 200mm

**Πένσες μηχανικών**

**Κωδικός Μήκος**  
0302160 160mm  
0302180 180mm  
0302200 200mm

**Πένσες 1000V**

VDE



**Κωδικός Μήκος**  
0306160 160mm  
0306180 180mm  
0306200 200mm

**Πένσες**

**Κωδικός Μήκος**  
611B160 160mm  
611B175 175mm  
611B200 200mm

**Τρυπητήρι δέρματος**

Για τρύπες 2-5 mm



**Κωδικός Μήκος**  
1042204

**Πένσα μολυβδοσφραγίδων**

Για σφραγίδες 8mm



**Κωδικός Μήκος**  
21-418013-0 130mm

**Πένσα μολυβδοσφραγίδων**

Για σφραγίδες 11mm

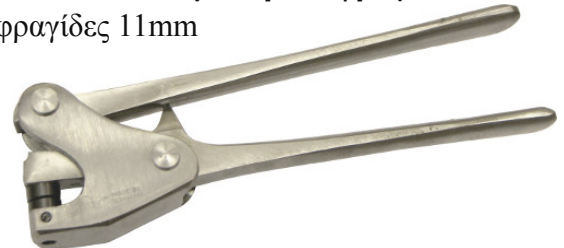

**Κωδικός Μήκος**  
21-418019-0 190mm



**Πένσα ασφαλειών 140mm****Κωδικός** Τύπος  
4811J0 IXE 8-13**Πένσα ασφαλειών 140mm****Κωδικός** Τύπος  
4811J1 IXE 12-25**Πένσα ασφαλειών 180mm****Κωδικός** Τύπος  
4811J2 IXE**Πένσα ασφαλειών 225mm****Κωδικός** Τύπος  
4811J3 IXE**Πένσα ασφαλειών γωνιακή 130mm****Κωδικός** Τύπος  
4821J01 KXE 8-13**Πένσα ασφαλειών γωνιακή 130mm****Κωδικός** Τύπος  
4821J11 KXE 12-25**Πένσα ασφαλειών γωνιακή 165mm****Κωδικός** Τύπος  
4821J21 KXE**Πένσα ασφαλειών γωνιακή 210mm****Κωδικός** Τύπος  
4821J31 KXE**Πένσα ασφαλειών 140mm****Κωδικός** Τύπος  
4911A0 IME 3-10**Πένσα ασφαλειών 140mm****Κωδικός** Τύπος  
4911A1 IME 10-25

## Πένσα ασφαλειών 180mm



Κωδικός Τύπος  
4911A2 ΙΜΕ



## Πένσα ασφαλειών 225mm



Κωδικός Τύπος  
4911A3 ΙΜΕ



## Πένσα ασφαλειών γωνακή 130mm



Κωδικός Τύπος  
4921A01 ΚΜΕ 3-10



## Πένσα ασφαλειών γωνακή 130mm



Κωδικός Τύπος  
4921A11 ΚΜΕ 10-25



## Πένσα ασφαλειών γωνακή 165mm



Κωδικός Τύπος  
4921A21 ΚΜΕ



## Πένσα ασφαλειών γωνακή 210mm



Κωδικός Τύπος  
4921A31 ΚΜΕ



## Μυτοτσίμπιδα ασφαλειών ίσια που κλείνουν



Κωδικός	Ανοιγμα	Μύτη	Επαναφορά
60905ASC	8-25mm	1,3mm	✓
609ASC	19-60mm	1,9mm	✓
60909ASC	40-100mm	2,3mm	✓
60912ASC	85-165mm	3,2mm	✗



## Μυτοτσίμπιδα ασφαλειών ίσια που ανοίγουν



Κωδικός	Ανοιγμα	Μύτη	Επαναφορά
60905ASO	8-25mm	1,3mm	✓
609ASO	19-60mm	1,9mm	✓
60909ASO	40-100mm	2,3mm	✓
60912ASO	85-165mm	3,2mm	✓



## Μυτοτσίμπιδα ασφαλειών κυρτά που κλείνουν



Κωδικός	Ανοιγμα	Μύτη	Επαναφορά
60905ABC	8-25mm	1,3mm	✓
609ABC	19-60mm	1,9mm	✓
60909ABC	40-100mm	2,3mm	✓
60912ABC	85-165mm	3,2mm	✓



## Μυτοτσίμπιδα ασφαλειών κυρτά που ανοίγουν



Κωδικός	Ανοιγμα	Μύτη	Επαναφορά
60905ABO	8-25mm	1,3mm	✓
609ABO	19-60mm	1,9mm	✓
60909ABO	40-100mm	2,3mm	✓
60912ABO	85-165mm	3,2mm	✓





### Πένσα ασφαλειών



**Κωδικός** **Τύπος**  
371004 J4 310



### Πένσα ασφαλειών γωνιακή



**Κωδικός** **Τύπος**  
373041 ΚΧΕ J41 310



### Πένσα ασφαλειών



**Κωδικός** **Τύπος**  
375004 A4 310



### Πένσα ασφαλειών γωνιακή

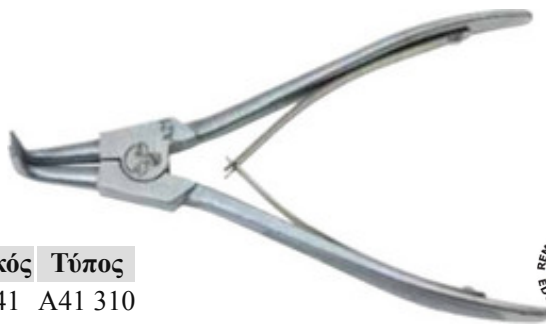

**Κωδικός** **Τύπος**  
377041 A41 310



### Πένσα ασφαλειών πιστονιών



**Κωδικός** **Τύπος**  
21-370000-0 A41 310



**Μυτοσίμπιδα ίσια**

**Κωδικός Μήκος**  
610B160 160mm  
610B200 200mm

**FORCE**

**Μυτοσίμπιδα κυρτά**

**Κωδικός Μήκος**  
610B150B 150mm  
610B200B 200mm

**FORCE**

**Μυτοσίμπιδο μακρύλαιμο**

**Κωδικός Μήκος**  
5047P1 280mm

**FORCE**

**Μυτοσίμπιδο μακρύλαιμο κυρτό**

**Κωδικός Μήκος**  
5047P2 280mm

**FORCE**

**Μυτοσίμπιδο μακρύλαιμο για μπουζί**

**Κωδικός Μήκος**  
5047P4 280mm

**FORCE**

**Μυτοσίμπιδο πολυχρηστικό**

Πένσα, μυτοσίμπιδο, κόφτης, απογυμνωτής, πρέσα ακροδεκτών



**Κωδικός Μήκος**  
1392200 200mm

**KNIPLEX**

**Μυτοσίμπιδο πολυχρηστικό 1000V**

Πένσα, μυτοσίμπιδο, κόφτης, απογυμνωτής, πρέσα ακροδεκτών  
Χωρίς ελατήριο



**Κωδικός Μήκος**  
1386200 200mm

**KNIPLEX**

**Μυτοσίμπιδο πολυχρηστικό 1000V**

Πένσα, μυτοσίμπιδο, κόφτης, απογυμνωτής, πρέσα ακροδεκτών



**Κωδικός Μήκος**  
1396200 200mm

**KNIPLEX**

**Μυτοσίμπιδο με πλαγιοκόφτη**

**Κωδικός Μήκος**  
2502160 160mm  
2612200 200mm

**KNIPLEX**

**Μυτοσίμπιδο με πλαγιοκόφτη 1000V**

**Κωδικός Μήκος**  
2506160 160mm  
2616200 200mm

**KNIPLEX**

**Μυτοσίμπιο με πλαγιοκόφτη κυρτό**

**Κωδικός Μήκος**  
2521160 160mm  
2621200 200mm

**Στρογγυλοσίμπιο**

**Κωδικός Μήκος**  
1901130 130mm

**Μυτοσίμπιο με πλαγιοκόφτη κυρτό**

**Κωδικός Μήκος**  
2622200 200mm

**Μυτοσίμπιο με πλαγιοκόφτη κυρτό 1000V**

**Κωδικός Μήκος**  
2526160 160mm  
2626200 200mm

**Μυτοσίμπιο για μπουζί**

**Κωδικός Μήκος**  
3891200 200mm

**Προσέλα τιτανίου ίσια**

**Κωδικός Μήκος**  
922305 120mm

**Προσέλα αντιστατική ίσια**

**Κωδικός Μήκος**  
922872 ESD 135mm

**Προσέλα αντιστατική πλάγια**

**Κωδικός Μήκος**  
923875 ESD 120mm

**Τσιμπίδα ίσια 1000V**

**Κωδικός Μήκος**  
922761 150mm

**Τσιμπίδα πλάγια 1000V**

**Κωδικός Μήκος**  
923764 150mm



**Κοφτάκι μίνι**

**Κωδικός** **Μήκος**  
7702115 115mm  
7722115 115mm

**Εμπροσθοκόφτης λοξός μίνι**

Για πλακέτες



**Κωδικός** **Μήκος**  
6462120 120mm

**Κοφτάκι μίνι αντιστατικό μυτερό**

**Κωδικός** **Μήκος**  
7732115 ESD 115mm

**Πλαγιοκόφτης**

**Κωδικός** **Μήκος**  
1422160 160mm

**Πλαγιοκόπτες καλωδίων**

**Κωδικός** **Μήκος**  
7002140 140mm  
7002160 160mm  
7002180 180mm

**Πλαγιοκόφτες**

**Κωδικός** **Μήκος**  
7302160 160mm

**Πλαγιοκόφτες ατσαλοσύρματος**

**Κωδικός** **Μήκος**  
7402160 160mm  
7402180 180mm  
7402200 200mm

**Πλαγιοκόφτης 1000V**

**Κωδικός** **Μήκος**  
1426160 160mm

**Πλαγιοκόφτες καλωδίων 1000V**

**Κωδικός** **Μήκος**  
7006160 160mm  
7006180 180mm

**Πλαγιοκόφτης 1000V**

**Κωδικός** **Μήκος**  
7306160 160mm

**Κόφτες σύρματος**

**Κωδικός Μήκος**  
612B160 160mm  
612B175 175mm

**FORCE****Πλαγιοκόφτης μεγάλης ισχύος**

**Κωδικός Μήκος**  
7372180 180mm

**KNIPEX****Πλαγιοκόφτης μακρός**

**Κωδικός Μήκος**  
7491250 250mm

**KNIPEX****Ψαλίδι καλωδίων Ø15**

**Κωδικός Μήκος**  
9511165 165mm

**KNIPEX****Ψαλίδι καλωδίων**

Με ελατήριο επαναφοράς



**Κωδικός Μήκος**  
9522165 165mm

**KNIPEX****Ψαλίδι καλωδίων**

**Κωδικός Μήκος**  
9512165 165mm

**KNIPEX****Ψαλίδι καλωδίων 1000V**

**Κωδικός Μήκος**  
9516165 165mm

**KNIPEX****Ψαλίδι καλωδίων**

**Κωδικός Μήκος**  
9512200 200mm

**KNIPEX****Ψαλίδι καλωδίων 1000V**

**Κωδικός Μήκος**  
9516200 200mm

**KNIPEX**

**Κόφτης καλωδίων με καστάνια ≤Ø52**

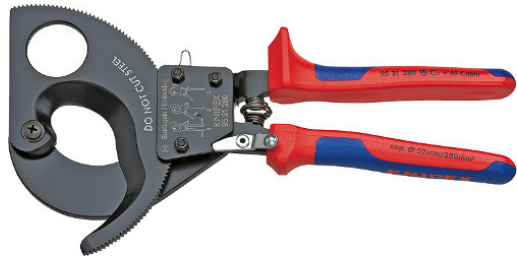

Κωδικός Μήκος  
9531280 280mm



**Κόφτης καλωδίων με καστάνια ≤Ø60**



Κωδικός Μήκος  
9532320 320mm



**Κόφτης ατσαλοσύρματος**



Κωδικός Μήκος  
7101200 200mm



**Κόφτης ατσαλοσύρματος**



Κωδικός Μήκος  
7112200 200mm



**Κόφτης καλωδίων - συρματόσχοινο**



Κωδικός Μήκος  
9561190 190mm



**Εμπροσθοκόφτης μπετού με μόνωση**



Κωδικός Μήκος  
33132 180mm



**Εμπροσθοκόφτες μπετού**



Κωδικός	Μήκος	Κωδικός	Μήκος
6801160	160mm	6801200S2	200mm
6801180	180mm	Με μουστάκια	
6801200	200mm	6801280	280mm



**Εμπροσθοκόφτης μπετού με μόνωση**



Κωδικός Μήκος  
6705200 200mm



**Εμπροσθοκόφτης μπετού με μόνωση**



Κωδικός Μήκος  
9911250 250mm



**Εμπροσθοκόφτης - σφυρί**



Κωδικός Μήκος  
5500300 300mm



**Κόφτες συρματόσχοινο**



Κωδικός	Τύπος
6927310	≤Ø7mm 310mm
6927600	≤Ø14mm 600mm



**Κόφτες μπετού ΒΤ Ιταλίας <sup>NEO</sup>**



Κωδικός	Τύπος
20831	480mm 7N
20841	650mm 9N
20851	750mm 12N
20861	900mm 14N



### Κόφτες συρματόσχοινο



Κωδικός Τύπος  
1643-200 3/16" 200mm

**TopMan**

### Απογυμνωτής καλωδίων



Κωδικός Μήκος  
1102160 160mm



### Απογυμνωτής καλωδίων 1000V



Κωδικός Μήκος  
1106160 160mm



### Απογυμνωτής ομοαξονικών καλωδίων



Κωδικός Μήκος  
166005SB 105mm



### Απογυμνωτής τηλεφωνικών καλωδίων



Κωδικός Μήκος  
166006SB 125mm



### Απογυμνωτής καλωδίων

Για ομοαξονικά, πολύκλινα και καλώδια δικτύου



Κωδικός Μήκος  
169501SB 135mm



### Γδάρτης καλωδίων



Κωδικός Μήκος  
1690130SB 130mm



### Απογυμνωτής καλωδίων αυτόματος

Με κόφτη



Κωδικός Μήκος  
1262180 180mm



### Απογυμνωτής αυτόματος

Με κόφτη



Κωδικός Μήκος  
1242195 195mm



## Γδάρτης καλωδίων 25mm και άνω



Κωδικός Μήκος  
1640150 150mm



## Γδάρτης καλωδίων 1000V



Κωδικός Μήκος  
9855 180mm



## Γδάρτης καλωδίων



Κωδικός Μήκος  
1620165SB 165mm



## Ανταλλακτική λεπίδα για τον γδάρτη 1620165SB



Κωδικός Μήκος  
1629165



## Γδάρτης καλωδίων



Κωδικός Μήκος  
1630135SB 165mm



## Γδάρτης καλωδίων



Κωδικός Μήκος  
1685125SB 125mm

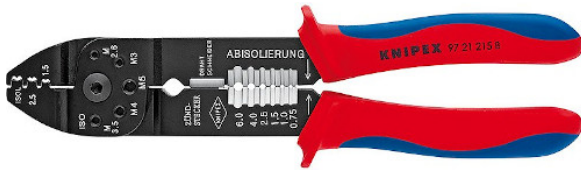
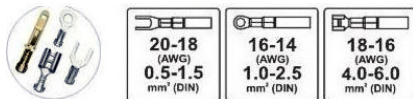

**Πρέσα ακροδεκτών****Κωδικός Μήκος**  
9771180 180mm**Πρέσα ακροδεκτών 1000V****Κωδικός Μήκος**  
9778180 180mm**Πρέσα ακροδεκτών****Κωδικός Μήκος**  
9721215B 215mm**Πρέσα τοποθέτησης τηλεφωνικών βυσμάτων****Κωδικός Μήκος**  
975112 200mm**Πρέσα μονωμένων ακροδεκτών καλωδίων****Κωδικός Τύπος**  
6801 233mm**Πρέσα μονωμένων ακροδεκτών καλωδίων****Κωδικός Τύπος**  
6802 233mm**Πρέσα γυμνών ακροδεκτών καλωδίων****Κωδικός Τύπος**  
6803 233mm**Πρέσα ακροδεκτών****Κωδικός Τύπος**  
68071 10-120mm<sup>2</sup>**Πρέσες ταλουρίτ****Κωδικός Τύπος Μήκος**  
1655-014 1,5-4mm 350mm  
1655-024 1,5-5mm 600mm

**Κλειδί φίλτρου με ιμάντα**



Κωδικός Διάμετρος  
61908 ≤110mm



**Φιλτρόκλειδο ιμάντα**



Κωδικός Διάμετρος  
61912 200mm



**Κλειδί φίλτρου με ιμάντα BT**

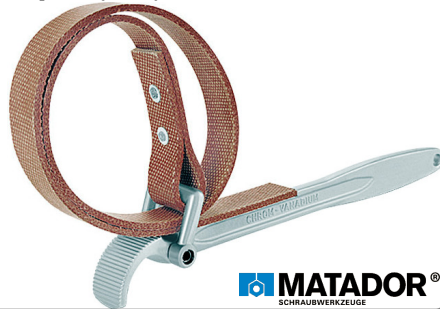

Κωδικός Διάμετρος  
04260001 ≤240mm



**Φιλτρόκλειδο με ιμάντα Ø25 - Ø160 <sup>NEO</sup>**



Κωδικός Τύπος  
U022-03-225 225mm



**Φιλτρόκλειδο καδένας**



Κωδικός Τύπος  
61911 110mm



**Φιλτρόκλειδο καδένας**

Μήκος αλυσίδας: 580mm. Λαβή: 225mm.



Κωδικός Τύπος  
61918 Ø30 - Ø160mm



**Αρπάγη φίλτρου λαδιού με  
καρέ 1/2" & 3/8"**



Κωδικός Τύπος  
61904A 63-102mm



**Ιμάντας φίλτρου λαδιού με  
καρέ 1/2"**



Κωδικός Τύπος  
619 Ø50-Ø150mm



**Αρπάγη φίλτρου λαδιού με  
καρέ 1/2"**



Κωδικός Τύπος  
61904 65mm-120mm



**Κλειδί φίλτρου με λάμα**

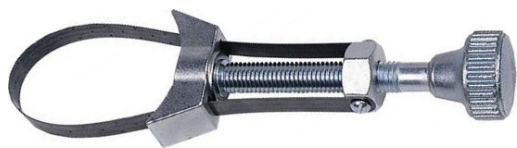

Κωδικός Διάμετρος  
61910 Ø65-Ø110  
61910L Ø110-Ø155



**Αλυσίδα φίλτρων λαδιού 1/2" <sup>NEO</sup>**



Κωδικός Τύπος  
61901 ≤Ø120mm



**Σετ 14 φιλτρόκλειδα καμπάνα**

65mm/14P, 65-67mm/14P,  
68mm/14P, 73mm/14P,  
74-76mm/15P, 75-77mm/15P,  
76mm/14P, 76mm/30P,  
80mm/15P, 80-82mm/15P  
90mm/15P, 93mm/15P,  
93mm/36P, 100mm/15P



**Κωδικός Τύπος**  
61915 1/2"-3/8"

**Σετ ταπόκλειδα**

17mm Hex - 14mm Hex, 10mm Hex - 12mm Hex,  
9mm Hex - 5/16" Hex, 8mm Sq. - 13mm Sq., 3/8" Sq. -  
11mm Sq.



**Κωδικός Τύπος**  
5051 5 τεμάχια

**Κλειδί τάπας λαδιού 9 τύπων**

**Κωδικός**  
890220

**Κλειδί allen 'Z' 8-10mm**

**Κωδικός**  
9U0706

**Πένσα κολιέδων**

**Κωδικός Μήκος**  
62519

**Πένσα κολιέδων**

**Κωδικός Μήκος**  
62520

**Πένσα κολιέδων boot clamp**

Μέγιστο άνοιγμα 30mm



**Κωδικός Τύπος**  
9G0104 170mm

**Ειδική πένσα σφιξίματος - αφαίρεσης ελατηριωτών κολάρων**

**Κωδικός**  
62518

**Πένσες εξαγωγής για τσιμούχες βαλβίδων**

**Κωδικός Τύπος**  
9G0102 250mm  
9G0103 280mm

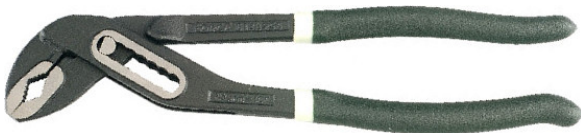

**Γκαζοτανάλια 250mm**

**Κωδικός Μήκος**  
613B250 250mm

**FORCE**

**Τσιμπίδες υδραυλικών 90°**

**Κωδικός Μήκος**  
1110302 3"  
1110402 4"

**RENNSTEIG**

**Γκαζοτανάλια 1000V**

**Κωδικός Μήκος**  
8726250 250mm

**ΚNIPEX**

**Γκαζοτανάλια παπαγαλάκι**

**Κωδικός Μήκος**  
8741250 250mm

**ΚNIPEX**

**Γκαζοτανάλια με μακριά μύτη**

**Κωδικός Μήκος**  
8751250 250mm

**ΚNIPEX**

**Γκαζοτανάλια για σφιγκτήρες**

**Κωδικός Μήκος**  
8551250A 250mm

**ΚNIPEX**

**Γκαζοτανάλιες υδραυλικών**

**Κωδικός Μήκος Κωδικός Μήκος**  
8701125 125mm 8701300 300mm  
8701150 150mm 8701400 400mm  
8701180 180mm 8701560 560mm  
8701250 250mm

**ΚNIPEX**

**Γκαζοτανάλια Ø2" με αυτόματη ρύθμιση**

**Κωδικός Μήκος**  
8721250 250mm

**ΚNIPEX**

**Γκαζοτανάλιες κλειδιά**

**Κωδικός Μήκος**  
8603125 125mm  
8603150 150mm  
8603180 180mm  
8603250 250mm  
8603300 300mm  
8603400 400mm

**ΚNIPEX**

**Τσιμπίδες υδραυλικού με αυτόματη ρύθμιση**

**Κωδικός Μήκος**  
8501250 250mm

**ΚNIPEX**

**Κάβουρες αλουμινίου**

**Κωδικός Τύπος Κωδικός Τύπος**  
68410A 10" 68424A 24"  
68412A 12" 68436A 36"  
68414A 14" 68448A 48"  
68418A 18"



**FORCE**

**Ψαλίδι σωλήνων PVC**



**Κωδικός Τύπος**  
1695-042 42mm

**TopMan**

**Ψαλίδι σωλήνων PVC**



**Κωδικός Τύπος**  
1050009 Ø42

**DÖNGES**

**Ταπόνη**

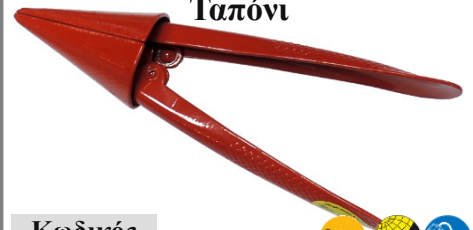

**Κωδικός**  
21-218000-0

**DÖNGES**

**Κουρμαδόρος χαλκοσωλήνων 0-180°**

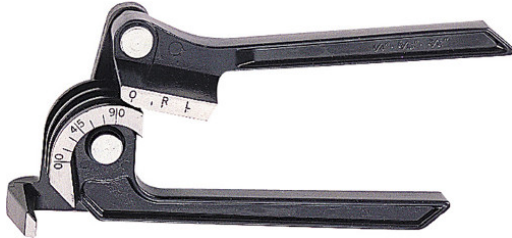

**Κωδικός Τύπος**  
65301 Ø6,8-10mm

**FORCE**

**Κλειδιά κουρμαδόροι**



**Κωδικός Μήκος**  
20610 Ø8/Ø10  
20620 Ø10/Ø12

**Kapriol**

**Γκριπ**



**Κωδικός Μήκος**  
1601804 180mm  
1602504 250mm  
1603004 300mm

**RENNSTEIG**

**Γκριπ με ίσια σαγώνια**



**Κωδικός Μήκος**  
1632504 250mm

**RENNSTEIG**

**Γκριπ με διπλά σαγώνια**



**Κωδικός Μήκος**  
66201 280mm

**FORCE**

**Γκριπ με διπλά σαγώνια**



**Κωδικός Μήκος**  
1712804 280mm

**RENNSTEIG**

**Γκριπ με βαθιά εσοχή (0-80mm)**

Σπαστή σιαγόνα 0-80mm



**Κωδικός Μήκος**  
66011D 280mm

**FORCE**

**Γκριπ με βαθιά εσοχή (0-80mm)**

Σπαστή σιαγόνα 0-80mm



**Κωδικός Μήκος**  
1732804 280mm

**RENNSTEIG**

### Σετ γερμανικά κλειδιά 8 τεμαχίων

6x7, 8x9, 10x11, 12x13, 14x15, 16x17, 18x19, 20x22mm



Κωδικός

5084



### Σετ γερμανικά κλειδιά 12 τεμαχίων

6x7 8x9 10x11  
12x13 14x15  
16x17 18x19  
20x22 21x23  
24x27 25x28  
30x32



Κωδικός Τύπος

5128C 12 τεμ



### Γερμανικά κλειδιά



Κωδικός	Διατομή	Κωδικός	Διατομή
7540506	5-6	7542123	21-23
7545507	5,5-7	7542426	24-26
7540607	6-7	7542427	24-27
7540809	8-9	7542528	25-28
7541011	10-11	7542729	27-29
7541213	12-13	7543032	30-32
7541415	14-15	7543436	34-36
7541617	16-17	7543641	36-41
7541819	18-19		
7542022	20-22		



### Γαλλικά κλειδιά



Κωδικός	Διατομή	Μήκος	Κωδικός	Διατομή	Μήκος
649100A	17mm	100mm	649300A	33mm	300mm
649150A	20mm	150mm	649375A	46mm	375mm
649200A	24mm	200mm			
649250A	29mm	250mm			



### Γαλλικό κλειδί 450mm

Κωδικός Τύπος

649450 18"



### Γερμανικά κλειδιά σφύρας



Κωδικός	Διατομή	Κωδικός	Διατομή	Κωδικός	Διατομή	Κωδικός	Διατομή
79122	22	79130	30	79143	43	79156	56
79123	23	79132	32	79144	44	79158	58
79124	24	79133	33	79145	45	79160	60
79125	25	79134	34	79146	46	79165	65
79126	26	79135	35	79148	48	79170	70
79127	27	79136	36	79150	50	79175	75
79128	28	79138	38	79152	52	79180	80
79129	29	79141	41	79155	55		



### Γαντζόκλειδα με νύχι



Κωδικός	Ανοιγμα	Κωδικός	Ανοιγμα
823035	15-35mm	823120	80-120mm
823050	35-50mm	823180	120-180mm
823080	50-80mm		



### Γαντζόκλειδα με πείρο



Κωδικός	Ανοιγμα	Κωδικός	Ανοιγμα
823A035	13-35mm	823A120	80-120mm
823A050	35-50mm	823A180	120-180mm
823A080	50-80mm		





## Γερμανοπολύγωνα



Κωδικός	Ανοιγμα	Κωδικός	Ανοιγμα	Κωδικός	Ανοιγμα	Κωδικός	Ανοιγμα
75506	6mm	75516	16mm	75526	26mm	75538	38mm
75507	7mm	75517	17mm	75527	27mm	75541	41mm
75508	8mm	75518	18mm	75528	28mm	75542	42mm
75509	9mm	75519	19mm	75529	29mm	75546	46mm
75510	10mm	75520	20mm	75530	30mm	75548	48mm
75511	11mm	75521	21mm	75532	32mm	75550	50mm
75512	12mm	75522	22mm	75533	33mm	75555	55mm
75513	13mm	75523	23mm	75534	34mm	75560	60mm
75514	14mm	75524	24mm	75535	35mm		
75515	15mm	75525	25mm	75536	36mm		

**FORCE**

## Γερμανοπολύγωνα ίντσας



Κωδικός	Ανοιγμα	Κωδικός	Ανοιγμα
7551.4	1/4"	7557.8	7/8"
7555.16	5/16"	75515.16	15/16"
7553.8	3/8"	7551.0	1"
7557.16	7/16"	7551.1.8	1 1/8"
7551.2	1/2"	7551.1.4	1 1/4"
7559.16	9/16"	7551.5.16	1 5/16"
7555.8	5/8"	7551.3.8	1 3/8"
75511.16	11/16"	7551.1.2	1 1/2"
7553.4	3/4"		
75513.16	13/16"		

**FORCE**

## Γερμανοπολύγωνα καστανίας



Κωδικός	Ανοιγμα	Κωδικός	Ανοιγμα
75708	8mm	75717	17mm
75709	9mm	75718	18mm
75710	10mm	75719	19mm
75711	11mm	75720	20mm
75712	12mm	75721	21mm
75713	13mm	75722	22mm
75714	14mm	75723	23mm
75715	15mm	75724	24mm
75716	16mm		

**FORCE**

## Γερμανοπολύγωνα καστανίας σπαστά



Κωδικός	Ανοιγμα	Κωδικός	Ανοιγμα
75708F	8mm	75715F	15mm
75709F	9mm	75716F	16mm
75710F	10mm	75717F	17mm
75711F	11mm	75718F	18mm
75712F	12mm	75719F	19mm
75713F	13mm		
75714F	14mm		

**FORCE**

## Γερμανοπολύγωνα κλειδιά καστανίας σταθερά με επιλογή φοράς



Κωδικός	Τύπος
75713R	13mm
75717R	17mm
75719R	19mm

**FORCE**

## Γερμανοπολύγωνα καστανίας σπαστά σε ίντσες



Κωδικός	Τύπος	Κωδικός	Τύπος
7575.16F	5/16"	7579.16F	9/16"
7573.8F	3/8"	7575.8F	5/8"
7577.16F	7/16"	7573.4F	3/4"
7571.2F	1/2"		

## Πολύγωνα κλειδιά



Κωδικός	Ανοιγμα	Κωδικός	Ανοιγμα
7590607	6X7mm	7592123	21X23mm
7590809	8X9mm	7592426	24X26mm
7591011	10X11mm	7592427	24X27mm
7591213	12X13mm	7592528	25X28mm
7591415	14X15mm	7592730	27X30mm
7591617	16X17mm	7592732	27X32mm
7591819	18X19mm	7593032	30X32mm
7592022	20X22mm		

## Πολύγωνα κοφτά



Κωδικός	Ανοιγμα	Κωδικός	Ανοιγμα
7510810	8X10mm	7511618	16X18mm
7510911	9X11mm	7511719	17X19mm
7511011	10X11mm	7511819	18X19mm
7511012	10X12mm	7511922	19X22mm
7511113	11X13mm	7512427	24X27mm
7511213	12X13mm	7513032	30X32mm
7511214	12X14mm		
7511415	14X15mm		

## Πολύγωνα κλειδιά ίσια



Κωδικός	Ανοιγμα	Κωδικός	Ανοιγμα
760M0607	6X7mm	760M2022	20X22mm
760M0809	8X9mm	760M2123	21X23mm
760M1011	10X11mm	760M2224	22X24mm
760M1213	12X13mm	760M2628	26X28mm
760M1415	14X15mm	760M2729	27X29mm
760M1617	16X17mm	760M3032	30X32mm
760M1819	18X19mm		

## Πολύγωνα κυρτά

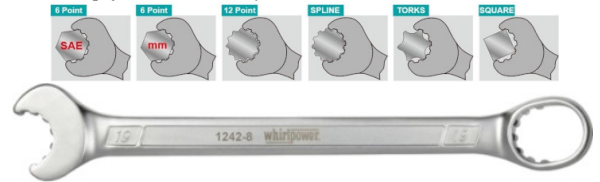

Κωδικός	Ανοιγμα	Κωδικός	Ανοιγμα
7610810	8X10mm	7611417	14X17mm
7611012	10X12mm	7611618	16X18mm
7611113	11X13mm	7611719	17X19mm
7611214	12X14mm	7611922	19X22mm
7611315	13X15mm		

Γερμανοπολύγωνα Duo Action **NEO**

Κωδικός	Τύπος	Κωδικός	Τύπος
1248-8-08	8mm	1248-8-14	14mm
1248-8-09	9mm	1248-8-15	15mm
1248-8-10	10mm	1248-8-16	16mm
1248-8-11	11mm	1248-8-17	17mm
1248-8-12	12mm	1248-8-18	18mm
1248-8-13	13mm	1248-8-19	19mm

## Πολύγωνα σφύρας

Κωδικός	Ανοιγμα	Κωδικός	Ανοιγμα	Κωδικός	Ανοιγμα
79322	22	79330	30	79340	40
79324	24	79332	32	79341	41
79325	25	79333	33	79346	46
79326	26	79334	34	79348	48
79327	27	79335	35	79350	50
79328	28	79336	36	79355	55
79329	29	79338	38	79360	60



**Καρυδάκια πίπα**

Κωδικός	Άνοιγμα	Κωδικός	Άνοιγμα
75308	8mm	75317	17mm
75309	9mm	75318	18mm
75310	10mm	75319	19mm
75311	11mm	75320	20mm
75312	12mm	75321	21mm
75313	13mm	75322	22mm
75314	14mm		
75315	15mm		
75316	16mm		

**Σωληνωτά κλειδιά**

Κωδικός	Άνοιγμα	Κωδικός	Άνοιγμα
1600067	6-7	160002528	25-28
1600089	8-9	160003032	30-32
160001011	10-11	160003236	32-36
160001213	12-13	160003641	36-41
160001415	14-15	160004146	41-46
160001617	16-17	180042-0	50-55
160001819	18-19	180043-0	55-60
160002022	20-22		
160002123	21-23		
160002426	24-26		
160002427	24-27		

**Κλειδιά Torx τύπου E ίσια**

Κωδικός	Τύπος	Μήκος
7560607	E6 - E7	112mm
7560608	E6 - E8	112mm
7560711	E7 - E11	125mm
7561012	E10 - E12	140mm
7561418	E14 - E18	180mm
7561622	E16 - E22	200mm
7562024	E20 - E24	224mm

**Κλειδιά Torx τύπου E γωνιακό 75°**

Κωδικός	Τύπος	Μήκος
7561012A	E10 - E12	175mm
7561418A	E14 - E18	215mm
7561622A	E16 - E22	235mm

**Κλειδιά φρένων**

Κωδικός	Τύπος
6080810	8-10 κλειστό
6080911	9-11 κλειστό
6081011	10-11 ανοικτό
6081113	11-13 ανοικτό

**Κλειδί με πείρους για παξιμάδια με εγκοπές**

Κωδικός	Άνοιγμα	Διατομή
23-179002-0	7-40mm	2mm
23-179003-0	11-60mm	3mm
23-179004-0	11-60mm	4mm
23-179005-0	14-100mm	5mm
23-179006-0	14-100mm	6mm

**Σετ γερμανοπώλυωνα καστανίας 12 τεμαχίων**

Κωδικός  
51210

**Σετ γερμανικά κλειδιά 11 τεμαχίων**

6X7-8X9-10X11-12X13-14X15-16X17-18X19-20X22-21X23-24X27-30X32



Κωδικός  
5111



**Σετ γερμανοπολύγωνα καστίνας 12 τεμαχίων**

Μεταλλική κασετίνα



Κωδικός  
51210M



**Σετ γερμανοπολύγωνα 26 τεμαχίων**

6-32mm



Κωδικός  
5261P



**Σετ γερμανοπολύγωνα 12 τεμαχίων**



Κωδικός Τύπος  
5121 8-19mm



**Σετ γερμανοπολύγωνα 12 τεμαχίων**

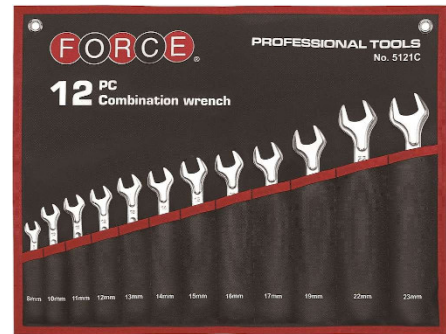

Κωδικός Τύπος  
5121C 8-23mm



**Σετ γερμανοπολύγωνα καστίνας 12 τεμαχίων**

Σπαστά  
8-19mm



Κωδικός  
K51210F



**Σετ πολύγωνα κλειδιά 8 τεμαχίων**

6X7, 8X9, 10X11, 12X13, 14X15, 16X17, 18X19, 21X22



Κωδικός  
5081



**Σετ πολύγωνα κλειδιά 12 τεμαχίων**

6X7 8X9 10X11 12X13 14X15 16X17 18X19 20X22 21X23 24X27 25X28 30X32 mm

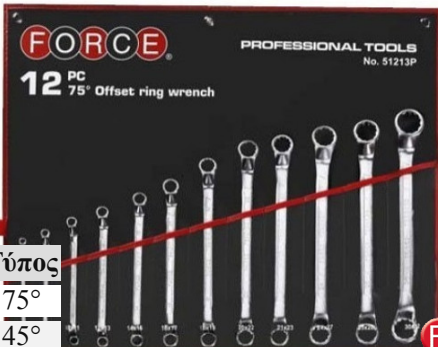

Κωδικός Τύπος  
51213P-8 75°  
51213C 45°



**Σετ γερμανοπολύγωνα κλειδιά 12 τεμαχίων**

8-22 mm



Κωδικός  
5123





## Κλειδιά allen κοντά



Κωδικός	Άνοιγμα	Κωδικός	Άνοιγμα	Κωδικός	Άνοιγμα	Κωδικός	Άνοιγμα
911-0100	1mm	911-0450	4,5mm	911-1100	11mm	911-1900	19mm
911-0127	1,27mm	911-0500	5mm	911-1200	12mm	911-2000	20mm
911-0150	1,5mm	911-0550	5,5mm	911-1300	13mm	911-2100	21mm
911-0200	2mm	911-0600	6mm	911-1400	14mm	911-2200	22mm
911-0250	2,5mm	911-0700	7mm	911-1500	15mm	911-2400	24mm
911-0300	3mm	911-0800	8mm	911-1600	16mm	911-2700	27mm
911-0350	3,5mm	911-0900	9mm	911-1700	17mm	911-3000	30mm
911-0400	4mm	911-1000	10mm	911-1800	18mm	911-3200	32mm

ARNDT

## Κλειδιά allen κοντά σε ίντσες



Κωδικός	Άνοιγμα	Κωδικός	Άνοιγμα	Κωδικός	Άνοιγμα
911-CV-B-0116	1/16"	911-CV-B-0316	3/16"	911-CV-B-0120	1/2"
911-CV-B-0564	5/64"	911-CV-B-0140	1/4"	911-CV-B-0916	9/16"
911-CV-B-0332	3/32"	911-CV-B-0932	9/32"	911-CV-B-0580	5/8"
911-CV-B-0180	1/8"	911-CV-B-0516	5/16"	911-CV-B-0340	3/4"
911-CV-B-0964	9/64"	911-CV-B-0380	3/8"	911-CV-B-0780	7/8"
911-CV-B-0532	5/32"	911-CV-B-0716	7/16"	911-CV-B-10000	1"

ARNDT

## Κλειδιά allen μακριά



Κωδικός	Άνοιγμα	Κωδικός	Άνοιγμα
911L-0200	2mm	911L-0550	5,5mm
911L-0250	2,5mm	911L-0600	6mm
911L-0300	3mm	911L-0700	7mm
911L-0350	3,5mm	911L-0800	8mm
911L-0400	4mm	911L-1000	10mm
911L-0450	4,5mm	911L-1200	12mm
911L-0500	5mm		

ARNDT

## Κλειδιά allen μακριά μπίλιας



Κωδικός	Άνοιγμα	Κωδικός	Άνοιγμα
302-0200	2mm	302-0600	6mm
302-0250	2,5mm	302-0700	7mm
302-0300	3mm	302-0800	8mm
302-0350	3,5mm	302-1000	10mm
302-0400	4mm	302-1200	12mm
302-0500	5mm		
302-0550	5,5mm		

ARNDT

**Σετ κλειδιά allen μπίλιας 6 τεμαχίων**Με σφαιρική κεφαλή  
2-3-4-5-6-8mmΚωδικός  
50637

**Σετ κλειδιά allen 9 τεμαχίων**

1,5-2-2,5-3-4-5-6-8-10mm

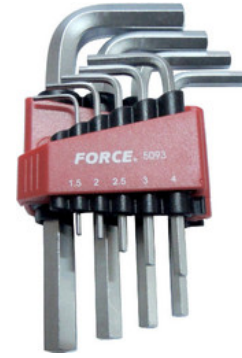
Κωδικός  
5093

**Σετ κλειδιά allen 9 τεμαχίων****Μακριά**  
1,5-2-2,5-3-4-5-6-8-10mmΚωδικός  
5093L

**Σετ κλειδιά allen 9 τεμαχίων****Μπίλας μακριά**  
1,5-2-2,5-3-4-5-6-8-10mmΚωδικός  
5093LB

**Σετ κλειδιά allen σε ίντσες 9 τεμαχίων**

1/16" 5/64" 3/32" 1/8" 5/32" 3/16" 1/4" 5/16" 3/8"

Κωδικός  
5093S

**Σετ κλειδιά allen σε ίντσες 9 τεμαχίων****Μακριά**  
1/16" 5/64" 3/32" 1/8"  
5/32" 3/16" 1/4" 5/16"  
3/8"Κωδικός  
5093LS

**Σετ κλειδιά allen σε ίντσες 9 τεμαχίων****Μπίλας μακριά**  
1/16" 5/64" 3/32" 1/8"  
5/32" 3/16" 1/4" 5/16"  
3/8"Κωδικός  
5093LBS



## Σετ κλειδιά allen 9 τεμαχίων

Μπίλας πολύ μακριά  
1,5-2-2,5-3-4-5-6-8-10mmΚωδικός  
307-9**ARNDT**

## Σετ κλειδιά allen σε ίντσες 9 τεμαχίων

Μπίλας πολύ μακριά  
1/16" 5/64" 3/32" 1/8"  
5/32" 3/16" 1/4" 5/16"  
3/8"Κωδικός  
308-9**ARNDT**

## Σετ κλειδιά allen 13 τεμαχίων

Πολύ μακριά  
2-2,5-3-4-5-6-7-8-10  
12-14-17-19mmΚωδικός  
5137XL**FORCE**

## Σετ κλειδιά άλλεν

Μπίλας πολύ μακριά

Κωδικός Τύπος  
5102XLB 1,27-10mm**FORCE**

## Σετ κλειδιά allen 9 τεμαχίων

Μακριά χρωματιστά  
1,5-2-2,5-3-4-5-6-8-10mmΚωδικός  
450542018**WITTE**  
WERKZEUGE

## Σετ κλειδιά allen 9 τεμαχίων

Μπίλας μακριά χρωματιστά  
1,5-2-2,5-3-4-5-6-8-10mmΚωδικός  
45055**WITTE**  
WERKZEUGE

## Σετ κλειδιά torx

8 τεμαχίων

Κωδικός Τύπος  
450560020 T9-T40**WITTE**  
WERKZEUGE

**Σετ κλειδιά Torx με τρύπα**

9 τεμαχίων  
Πολύ μακριά  
T10-T15-T20  
T25-T27-T30  
T40-T45-T50



**Κωδικός**  
6067-1050

**ARNDT**

**Σετ κλειδιά torx μακριά**

9 τεμαχίων  
T10, T15, T20,  
T25, T27, T30,  
T40, T45, T50

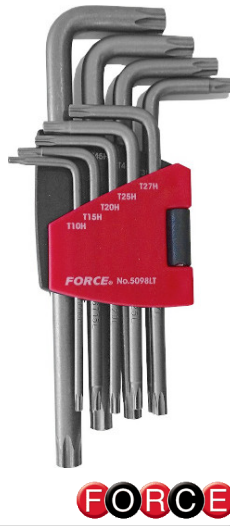

**Κωδικός Τύπος**  
5098L   
5098LT

**FORCE**

**Σετ κλειδιά torx με τρύπα πολύ μακριά** **NEO**

9 τεμαχίων  
T10, T15, T20,  
T25, T27, T30,  
T40, T45, T50



**Κωδικός**  
5098XLT

**FORCE**

**Σετ κλειδιά torx 9 τεμαχίων**

T10, T15, T20,  
T25, T27, T30,  
T40, T45, T50

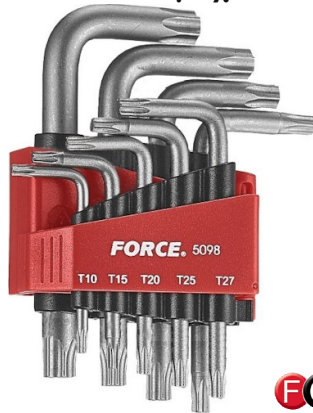

**Κωδικός Τύπος**  
5098   
5098T

**FORCE**

**Κλειδιά torx**

Κωδικός	Ανοιγμα	Κωδικός	Ανοιγμα
600-0600	T6	600-2700	T27
600-0700	T7	600-3000	T30
600-0800	T8	600-4000	T40
600-0900	T9	600-4500	T45
600-1000	T10	600-5000	T50
600-1500	T15	600-5500	T55
600-2000	T20	600-6000	T60
600-2500	T25		



**ARNDT**

**Κλειδιά torx με τρύπα**

Κωδικός	Ανοιγμα	Κωδικός	Ανοιγμα
601-0600	TT6	601-2700	TT27
601-0700	TT7	601-3000	TT30
601-0800	TT8	601-4000	TT40
601-0900	TT9	601-4500	TT45
601-1000	TT10	601-5000	TT50
601-1500	TT15	601-5500	TT55
601-2000	TT20	601-6000	TT60
601-2500	TT25		



**ARNDT**

**Κλειδιά γωνιακά Ribe Polydrive**

Κωδικός	Ανοιγμα	Κωδικός	Ανοιγμα
6030-004	M4	6030-012	M12
6030-005	M5	6030-014	M14
6030-006	M6	6030-016	M16
6030-008	M8		
6030-010	M10		



**ARNDT**

**Κλειδιά γωνιακά πολύσφηνα XZN**

Κωδικός	Ανοιγμα	Κωδικός	Ανοιγμα
200-004	M4	200-012	M12
200-005	M5	200-014	M14
200-006	M6	200-016	M16
200-008	M8		
200-010	M10		



**ARNDT**

**Σετ κλειδιά πεντάστερα με τρύπα**

TS10 - TS15 - TS20  
TS25 - TS27 - TS30  
TS40 - TS45 - TS50



**Κωδικός**  
50913

**FORCE**

**Σετ καρυδάκια 1/4" 46 τεμαχίων**

Καρυδάκια : 4-4,5-5-5,5-6-7-8-9-10-11-12-13-14  
 Καρυδάκια Allen : 3-4-5-6-7-8 ύψους 32 mm  
 Καρυδάκια Torx : T8-T10-T15-T20-T25-T27-T30-T40  
 Καρυδάκια μύτη ίσια : 4-5,5-7  
 Καρυδάκια μύτη phillips : PH1-PH2-PH3  
 Καρυδάκια μύτη rozidrive : PZ1-PZ2-PZ3  
 Καστάνια  
 Προέκταση καστάνιας 50 mm  
 Προέκταση καστάνιας 100 mm  
 Πολύσπαστο σταυρός  
 Μανέλα T  
 Κατσαβιδολαβή για καρυδάκια  
 Προέκταση flexible για καρυδάκια 145 mm  
 Κλειδί Allen : 1,27-1,5-2-2,5 mm

**Κωδικός**

2462

**Σετ καρυδάκια 1/4" και μύτες 57 τεμαχίων**

Καρυδάκια 4-4,5-5-5,5-6-7-8-9-10-11-12-13-14 mm  
 Εξάγωνα μακριά καρυδάκια 6-7-8-10 mm  
 Θηλυκά torx E4-E5-E6-E7-E8-E10  
 Άλλεν 3-4-5-6-7-8 -10 mm  
 Μύτες Phillips PH1-PH2-PH3  
 Μύτες Rozidriv PZ1-PZ2-PZ3  
 Μύτες ίσιες 4-5,5-6,5 mm  
 Μύτες torx T8-T10-T15-T20-T25-T27-T30-T40  
 Καστάνια με 72 δόντια  
 Προκτάσεις 2"-4"  
 Ολισθαίνουσα μανέλα  
 Προσαρμογέα σε εξάγωνο  
 Κατσαβίδι για καρυδάκια  
 Άλλεν 1,27-1,5-2-2,5 mm

**Κωδικός**

2571

**Σετ καρυδάκια 1/4" & 1/2" 94 τεμαχίων**

1/4"  
 Καρυδάκια 4-4,5-5-5,5-6-7-8-9-10-11-12-13-14 mm  
 Μακριά καρυδάκια 6-7-8-10-11-12-13-14 mm  
 Θηλυκά torx E4-E5-E6-E7-E8-E10  
 Άλλεν 3-4-5-6-7-8 -10 mm  
 Μύτες Phillips PH1-PH2-PH3 - Μύτες Rozidriv PZ1-PZ2-PZ3  
 Μύτες ίσιες 4-5,5-6,5 mm  
 Μύτες torx T8-T10-T15-T20-T25-T27-T30-T40  
 1/2"  
 Καρυδάκια 10-11-12-13-14-15-16-17-18-19-20-21-22-24-27-30-32 mm  
 Μακριά καρυδάκια 14-15-17-19-22 mm  
 Καστάνιες - Προκτάσεις - Ολισθαίνουσες μανέλες  
 Προσαρμογέα σε εξάγωνο - Κατσαβίδι για καρυδάκια  
 Άλλεν 1,27-1,5-2-2,5 mm

**Κωδικός**

4941-5



**Σετ καρυδάκια 1/4" & 1/2" 108 τεμαχίων**

1/4"

Καρυδάκια 4-4.5-5-5.5-6-7-8-9-10-11-12-13-14 mm

Μακριά καρυδάκια 6-7-8-10-11-12-13-14 mm

Θηλυκά torx E4-E5-E6-E7-E8-E10

Άλλεν 3-4-5-6-7-8 -10 mm

Μύτες Phillips PH1-PH2-PH3 - Μύτες Pozidriv PZ1-PZ2-PZ3

Μύτες ίσιες 4-5,5-6,5 mm

Μύτες torx T8-T10-T15-T20-T25-T27-T30-T40

1/2"

Καρυδάκια 10-11-12-13-14-15-16-17-18-19-20-21-22-24-27-30-32 mm

Μακριά καρυδάκια 14-15-17-19-22 mm

Καστάνιες - Προκτάσεις - Ολισθαίνουσες μανέλες

Προσαρμογέα σε εξάγωνο - Κατσαβίδι για καρυδάκια

Άλλεν 1,27-1,5-2-2,5 mm

**Κωδικός**

41081-5

**Σετ καρυδάκια 1/2" 24 τεμαχίων**

Καρυδάκια 10-11-12-13-14-15-16-17-18-19-20-21-22-24-27-30-32 mm

Προεκτάσεις 5"-10"

Καστάνια

Μανέλα

Ολισθαίνουσα μανέλα

Αρθρωτή μανέλα

Σταυρός καστάνιας

**Κωδικός**

4243-5

**FORCE****Σετ καρυδάκια 3/8" 24 τεμαχίων**

17 Καρυδάκια:

6-7-8-9-10-11-12-13-14-15-16-17-18-19-20-21-22 mm

Καστάνια

Ολισθαίνουσα μανέλα

Πολύσπαστο

Προεκτάσεις 75 mm

Προεκτάσεις 150 mm

Καρυδάκια για μπουζί 16 mm

Καρυδάκια για μπουζί 20,6 mm

**Κωδικός**

3251

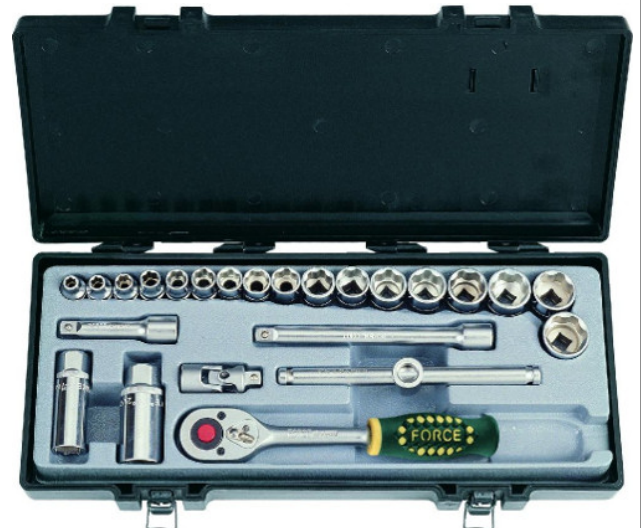
**FORCE**



## Σετ καρδάρια 19 τεμαχίων σε κασετίνα

4-14 mm



Κωδικός Τύπος  
2203-5 1/4"



## Σετ καρδάρια 24 τεμαχίων σε κασετίνα

10-32mm



Κωδικός Τύπος  
4246-5 1/2"



## Σετ καρδάρια 1/4" και 1/2"

Καρδάρια 4-32mm

Καρδάρια μακριά 6-22mm

Καρδάρια μπουζί 16-20,6mm

Καρδάρια E4-E24

Καστάνιες, μανέλες, προεκτάσεις, πολύσπαστα 1/4" και 1/2"

Μύτες ίσιες, Phillips, Pozidrive, Allen, Torx



Κωδικός Τύπος  
41082-5 108 τεμάχια



## Σετ εξάγωνα καρδάρια 3/4" 14 τεμαχίων

22-24-27-30-32-36-38-41-46-50mm



Κωδικός Τύπος  
6141B-5 3/4"



## Σετ καρδάρια 3/4" 20 τεμαχίων

19-21-22-23-24-26-27-29-30-32-35-36-38-41-46-50mm



Κωδικός Τύπος  
6201B-5 εξάγωνα  
6201B πολύγωνα



## Σετ πολύγωνα καρδάρια 1" 14 τεμαχίων

36-41-46-50-55-60-65-70-75-80mm



Κωδικός  
8141



## Σετ εργαλεία για συρτάρι φορμαίου 580X375mm

- ο Σειρά 1/2"
  - Καρδάρια 8-10-11-12-13-14-15-16-17-18-19-20-21-22-23-24-26-27-28-30-32mm
  - Καρδάρια μακριά 10-12-13-14-15-17-19-21-22-23-24-27-30-32mm
  - Καστάνια 24 δοντιών
  - Μανέλα
  - Προέκταση 125mm
  - Προέκταση 250mm
  - Ολισθαίνουσα μπάρα
  - Πολύσπαστο
- ο 4 πέννες ασφαλειών

Κωδικός Τύπος  
4451 45 τεμάχια



**Σετ κοντά καρδιάκια 1/4" NEO**

13 τεμάχια. Σε λάμα στήριξης  
4-4,5-5-5,5-6-7-8-9-10-11-12-13-14mm



Κωδικός	Τύπος
2133-5	Εξάγωνα
2133	Πολύγωνα

**Σετ μακριά καρδιάκια 1/4" NEO**

11 τεμάχια. Σε λάμα στήριξης  
4, 5, 6, 7, 8, 9, 10, 11, 12, 13, 14mm



Κωδικός	Τύπος
21115	Εξάγωνα
21115-9	Πολύγωνα

**Σετ κοντά καρδιάκια 1/2" NEO**

12 τεμάχια. Σε θήκη στήριξης  
10, 12, 13, 14, 15, 16, 17, 18, 19, 21, 22, 24mm



Κωδικός	Τύπος
4125	Εξάγωνα
4125-9	Πολύγωνα

**Σετ μακριά καρδιάκια 1/2" NEO**

9 τεμάχια. Σε λάμα στήριξης  
10, 12, 13, 14, 17, 19, 21, 22, 24mm



Κωδικός	Τύπος
40911	Εξάγωνα
40911-9	Πολύγωνα

**Βάσεις για καρδιάκια**

Κωδικός	Τύπος	Θέσεις	Μήκος
819212	1/4"	12	200mm
819230	1/4"	30	560mm
819409	1/2"	9	260mm
819420	1/2"	20	560mm

**Σετ καρδιάκια 22 τεμαχίων σε κασετίνα NEO**

Καρδιάκια 10, 11, 12, 13, 14,  
15, 16, 17, 18, 19, 22, 24, 27,  
30, 32mm

Καστάνια

Προεκτάσεις 125 και 250mm

Καρδιάκια μπουζί 16 και  
20,6mm

Σταυρός

Adaptor 3/8"(F)x1/2"(M)

Κωδικός	Τύπος
4223	1/2"

**Σετ καρδιάκια 1/2" 24 τεμαχίων σε κασετίνα NEO**

5/16", 3/8", 7/16", 1/2", 9/16", 19/32", 5/8", 11/16", 3/4", 25/32",  
13/16", 7/8", 15/16", 1", 1 1/16", 1 1/8", 1 3/16", 1 1/4"

Σε ίντσες

Κωδικός	Τύπος
4246S-5	Εξάγωνα
4246S-9 (4246S)	Πολύγωνα



**Σετ καρυδάκια 1/4" & 1/2" και εργαλεία 77 τεμαχίων**

Περιέχει μίνι φακό led κλιπ, 9 γερμανοπολύγωνα 8-19mm, πένσα, μυτοσίμπιδο, τσιμπίδα υδραυλικών, μαχαιράκι με σπαστές λάμες, τέσσερ συνεχείας, σετ καρυδάκια 1/4" 4 - 12mm, σετ καρυδάκια 1/2" 10 - 24mm και δύο μπουζόκλειδα, σετ κλειδιά άλλεν 1,27 - 10mm, πριόνι, σφυρί 300gr, μύτες κατσαβιδιού ίσιες - Phillips - Pozidrive και μαγνητικό οδηγό κατσαβίδι

**Κωδικός**

4771

**Σετ καρυδάκια 1/4" 3/8" & 1/2" και εργαλεία 142 τεμαχίων**

Μύτες 1/4": Phillips, Pozidrive, Ίσιες μύτες, Allen, Torx  
Εξάγωνα καρυδάκια 1/4": 4~10mm, Θηλυκά torx E4~E8  
Καρυδάκια πολύγωνα 3/8": 6~22mm  
Εξάγωνα καρυδάκια 1/2": 8~32mm, Θηλυκά torx 1/2": E10~E20  
Μπουζόκλειδα 1/2": 16-20,6mm  
Γερμανοπολύγωνα 6~24mm  
Πολύγωνα κλειδιά: 8X10-10X12-11X13-12X14-17X19  
Κλειδιά άλλεν: 2,5~14mm  
Σφυρί 300 γραμμαρίων, Πένσα 180 χιλιοστών  
Σκύλα (grip) 250 χιλιοστών, Κοντό κατσαβίδι Phillips PH1  
Κατσαβίδι Phillips PH2, Κατσαβίδι κρούσης Phillips PH2  
Κοντό κατσαβίδι ίσιο 5,5mm, Κατσαβίδι ίσιο 6,5mm  
Κατσαβίδι κρούσης ίσιο 6,5mm

**Κωδικός**

41421

**Σετ εργαλεία 34 τεμαχίων**

Περιέχει μίνι φακό led κλιπ, 9 γερμανικά κλειδιά 6-17mm, πένσα, μυτοσίμπιδο, τσιμπίδα υδραυλικών, γαλλικό κλειδί, ψαλίδι, μετροταινία, πριόνι, σφυρί 300gr, 5 κατσαβίδια ίσια - 3 κατσαβίδια Phillips, σετ κλειδιά άλλεν

**Κωδικός**

5341

Σετ καρδιάκια Allen 1/2" 10 τεμαχίων  
4-5-6-7-8-10-12-14-17-19mm



Κωδικός  
4111

**FORCE**

Σετ καρδιάκια Allen ίντσας 1/2" 10 τεμαχίων  
5/32"-3/16"-7/32"-1/4"-5/16"-3/8"-1/2"-9/16"-5/8"-3/4"



Κωδικός  
4111S

**FORCE**

Σετ καρδιάκια Torx 1/2" 9 τεμαχίων  
T20-T25-T27-T30-T40-T45-T50-T55-T60



Κωδικός  
4102

**FORCE**

Σετ Torx καρδιάκια 1/2" 16 τεμαχίων  
T30-T40-T45-T50-T55-T60-T70  
E10-E11-E12-E14-E16-E18-E20-E22-E24



Κωδικός  
4171

**FORCE**

Σετ Torx θηλυκά καρδιάκια 1/2" 9 τεμαχίων  
E10-E11-E12-E14-E16-E18-E20-E22-E24



Κωδικός  
4093

**FORCE**

Σετ πολύσφηγα καρδιάκια 1/2" 8 τεμαχίων  
M5 - M16mm



Κωδικός  
40811

**FORCE**

Σετ καρδιάκια 21 τεμαχίων σε κασετίνα  
8-32mm



Κωδικός Τύπος  
4212 1/2"

**FORCE**

Εκθετήριο με καρδιάκια 163 τεμαχίων



Κωδικός Τύπος  
41631S 1/2"

**FORCE**

**Καστάνια 1/4" με 24 δόντια**Κωδικός Μήκος  
80222 155mm**FORCE****Καστάνια 1/4" με 72 δόντια**Κωδικός Μήκος  
80229 115mm**FORCE****Καστάνια 3/8" με 24 δόντια**Κωδικός Μήκος  
80232 275mm**FORCE****Καστάνια 3/8" με 72 δόντια**Κωδικός Μήκος  
80239 195mm**FORCE****Καστάνια 1/2" με 24 δόντια**Κωδικός Μήκος  
80242 270mm**FORCE****Καστάνια 1/2" με 72 δόντια**Κωδικός Μήκος  
80249 245mm**FORCE****Καστάνια σπαστή 1/2" <sup>NEO</sup>**

72 δόντια

Κωδικός Μήκος  
802423 312mm**FORCE****Καστάνια 3/4" με 72 δόντια**Κωδικός Μήκος  
8026505 505mm**FORCE****Βαθμιδωτό κλειδί με καστάνια**

Σετ 3 τεμαχίων

Κωδικός Τύπος  
4031 1/2"**FORCE****Αναλλακτικό βαθμιδωτό κλειδί**

1,5x8,9mm  
 3/8" 7/16" 15/32" 1/2" 35/64" 3/4" 27/32" 7/8"

Κωδικός Τύπος  
68901 1/2"**FORCE****Καρέ σύνδεσης με καρυδάκια**Κωδικός Τύπος  
802412D 1/2"**FORCE****Αναλλακτικό καρέ για μανέλες 1/2"**Κωδικός  
8014380-P**FORCE**

## Μανέλα γωνία 1/2"



Κωδικός Τύπος  
8154260 260mm

**FORCE**

## Ολισθαίνουσα μανέλα μπάρα T 1/4"



Κωδικός Μήκος  
8032115 115mm

**FORCE**

## Ολισθαίνουσα μανέλα μπάρα T 3/8"

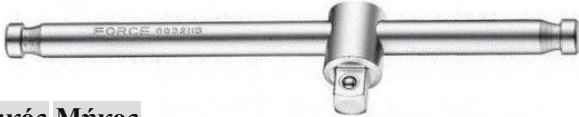

Κωδικός Μήκος  
8033165 165mm

**FORCE**

## Ολισθαίνουσα μανέλα μπάρα T 1/2"



Κωδικός Μήκος  
8034250 250mm

**FORCE**

## Ολισθαίνουσα μανέλα μπάρα T 3/4"



Κωδικός Μήκος  
8036450 450mm  
8036500 500mm

**FORCE**

## Ολισθαίνουσα μανέλα μπάρα T 1"



Κωδικός Μήκος  
8038550 550mm

**FORCE**

## Αρθρωτές μανέλες 1/2" μακριές



Κωδικός Μήκος  
8014380 380mm  
8014600 600mm

**FORCE**

## Προεκτάσεις καστάνιας 1/4"



Κωδικός Μήκος  
8042050 50mm  
8042075 75mm  
8042100 100mm  
8042150 150mm

**FORCE**

## Προεκτάσεις καστάνιας 3/8" ανοικτής γωνίας



Κωδικός Μήκος  
8043075W 75mm  
8043150W 150mm  
8043225W 225mm

**FORCE**

## Προεκτάσεις καστάνιας 3/8"



Κωδικός Μήκος Κωδικός Μήκος  
8043075 75mm 8043150 150mm  
8043100 100mm 8043200 200mm  
8043125 125mm

**FORCE**

## Προεκτάσεις μανέλας 1/2"



Κωδικός Μήκος  
8044050 50mm  
8044075 75mm  
8044125 125mm  
8044250 250mm

**FORCE**

## Προεκτάσεις καστάνιας 1/2" ανοικτής γωνίας



Κωδικός Μήκος Κωδικός Μήκος  
8044050W 50mm 8044125W 125mm  
8044075W 75mm 8044200W 200mm

**FORCE**

## Προεκτάσεις μανέλας 3/4"



Κωδικός Μήκος  
8046125 125mm  
8046200 200mm  
8046400 400mm

**FORCE**

## Προεκτάσεις καστανίας 1"



Κωδικός	Τύπος
8048200	200mm
8048400	400mm

Προέκταση βιδολόγων για καρυδάκια 1/4"  
με εξάγωνη υποδοχή 1/4"

Κωδικός	Μήκος
80922175	175mm



## Εύκαμπτη προέκταση για καρυδάκια 1/4"



Κωδικός	Τύπος
8111	150mm
8112	175mm



## Κατσαβίδι για καρυδάκια 1/4" κοντό



Κωδικός
8142

Κατσαβίδι για καρυδάκια 1/4"  
Με υποδοχή για υποβοήθηση

Κωδικός
8143



## Σπαστό



Κωδικός	Τύπος
80531	3/8"
80541	1/2"
80561	3/4"



## Αντάπτορας για μύτες 1/4"



Κωδικός
81022

Αντάπτορες για εξάγωνες μύτες σε καστανία 1/2"  
Μήκος 38mm

Κωδικός	Τύπος
81042	1/4"
81045	5/16"
81047	10mm



## Συστολές μανέλας



Κωδικός	Τύπος	Κωδικός	Τύπος
80923	1/4"Fx3/8"Μ	80946	1/2"Fx3/4"Μ
80932	3/8"Fx1/4"Μ	80964	3/4"Fx1/2"Μ
80934	3/8"Fx1/2"Μ	80968	3/4"Fx1"Μ
80942	1/2"Fx1/4"Μ	80986	1"Fx3/4"Μ
80943	1/2"Fx3/8"Μ		



## Καρυδάκι 1/2" για μπεκ Diesel ΝΕΟ



Κωδικός	Τύπος
12741-21-210	21mm



## Καρυδάκια εξάγωνα 1/4"



Κωδικός	Τύπος	Κωδικός	Τύπος
52505	5	52510	10
525055	5,5	52511	11
52506	6	52512	12
52507	7	52513	13
52508	8	52514	14
52509	9		

## Καρυδάκια πολύγωνα 1/4"



Κωδικός	Τύπος
5291.2	1/2"
5291.4	1/4"
5293.8	3/8"
5295.16	5/16"
5297.16	7/16"
5299.16	9/16"

## Καρυδάκια εξάγωνα 1/4" σε ίντσες



Κωδικός	Τύπος
5251.4	1/4"
5255.16	5/16"
5253.8	3/8"
5257.16	7/16"

## Καρυδάκια πολύγωνα 1/4" μακριά



Κωδικός	Τύπος	Κωδικός	Τύπος
5295005	5	5295010	10
52950055	5,5	5295011	11
5295006	6	5295012	12
5295007	7	5295013	13
5295008	8	5295014	14
5295009	9		

## Καρυδάκια 1/4" surface drive μακριά



Κωδικός	Τύπος	Κωδικός	Τύπος
5275005	5	5275010	10
52750055	5,5	5275011	11
5275006	6	5275012	12
5275007	7	5275013	13
5275008	8	5275014	14
5275009	9		

## Καρυδάκια εξάγωνα 3/8"



Κωδικός	Τύπος	Κωδικός	Τύπος	Κωδικός	Τύπος
53506	6mm	53513	13mm	53520	20mm
53507	7mm	53514	14mm	53521	21mm
53508	8mm	53515	15mm	53522	22mm
53509	9mm	53516	16mm	53523	23mm
53510	10mm	53517	17mm	53524	24mm
53511	11mm	53518	18mm		
53512	12mm	53519	19mm		

## Καρυδάκια πολύγωνα 3/8"

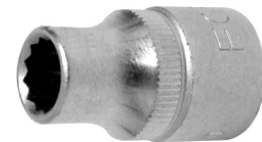

Κωδικός	Τύπος	Κωδικός	Τύπος
5391.4	1/4"	5399.16	9/16"
5395.16	5/16"	5395.8	5/8"
5393.8	3/8"	5393.4	3/4"
5397.16	7/16"		
5391.2	1/2"		

## Εύκαμπτα καρυδάκια για μπουζί με καρτέ 3/8" μήκος 95 χιλιοστά



Κωδικός	Τύπος
807316BM	16mm

## Ειδικά καρυδάκια για μπουζί με καρτέ 3/8" μήκος 250 χιλιοστά



Κωδικός	Τύπος
807325014M	14mm
807325016M	16mm

## Καρυδάκια εξάγωνα 1/2"

Κωδικός	Τύπος	Κωδικός	Τύπος	Κωδικός	Τύπος	Κωδικός	Τύπος
54507	7mm	54515	15mm	54523	23mm	54532	32mm
54508	8mm	54516	16mm	54524	24mm	54533	33mm
54509	9mm	54517	17mm	54525	25mm	54534	34mm
54510	10mm	54518	18mm	54526	26mm	54535	35mm
54511	11mm	54519	19mm	54527	27mm	54536	36mm
54512	12mm	54520	20mm	54528	28mm		
54513	13mm	54521	21mm	54529	29mm		
54514	14mm	54522	22mm	54530	30mm		

**FORCE**

## Καρυδάκια πολύγωνα 1/2"

Κωδικός	Τύπος	Κωδικός	Τύπος	Κωδικός	Τύπος	Κωδικός	Τύπος
54908	8mm	54920	20mm	54933	33mm	5491.4	1/4"
54909	9mm	54921	21mm	54934	34mm	5495.16	5/16"
54910	10mm	54922	22mm	54935	35mm	5493.8	3/8"
54911	11mm	54923	23mm	54936	36mm	5497.16	7/16"
54912	12mm	54924	24mm			5491.2	1/2"
54913	13mm	54925	25mm			5499.16	9/16"
54914	14mm	54926	26mm			5495.8	5/8"
54915	15mm	54927	27mm			54919.32	19/32"
54916	16mm	54928	28mm			54911.16	11/16"
54917	17mm	54929	29mm			5493.4	3/4"
54918	18mm	54930	30mm			54913.16	13/16"
54919	19mm	54932	32mm			54915.16	15/16"
						5491.0	1"
						5491.1.16	1 1/16"
						5491.1.8	1 1/8"
						5491.3.16	1 3/16"
						5491.1.4	1 1/4"

**FORCE**

## Καρυδάκια εξάγωνα 1/2" σε ίντσες

Κωδικός	Τύπος	Κωδικός	Τύπος	Κωδικός	Τύπος
5451.4	1/4"	5455.8	5/8"	5451.0	1
5455.16	5/16"	54511.16	11/16"	5451.1.16	1 1/16"
5453.8	3/8"	5453.4	3/4"	5451.1.8	1 1/8"
5457.16	7/16"	54525.32	25/32"	5451.3.16	1 3/16"
54515.32	15/32"	54513.16	13/16"	5451.1.4	1 1/4"
5451.2	1/2"	5457.8	7/8"		
5459.16	9/16"	54515.16	15/16"		

**FORCE**

## Καρυδάκια μακριά εξάγωνα 1/2"



Κωδικός	Τύπος	Κωδικός	Τύπος
5457708	8mm	5457719	19mm
5457710	10mm	5457721	21mm
545777.16	7/16"	5457724	24mm
5457713	13mm	5457727	27mm
5457715	15mm	5457729	29mm
5457716	16mm	5457730	30mm
5457717	17mm	5457732	32mm

**FORCE**

## Καρυδάκια μπουζί 1/2"



Κωδικός	Τύπος
807414M	14mm
807416M	16mm
807418M	18mm
807420.6	20,6mm
807420.6M	20,6mm

**FORCE**

## Καρυδάκια πολύγωνα 1/2" μακριά

Κωδικός	Τύπος	Κωδικός	Τύπος	Κωδικός	Τύπος
5497708	8mm	5497718	18	5497728	28mm
5497709	9mm	5497719	19mm	5497729	29mm
5497710	10mm	5497720	20mm	5497730	30mm
5497711	11mm	5497721	21mm	5497732	32mm
5497712	12mm	5497722	22mm		
5497713	13mm	5497723	23mm		
5497714	14mm	5497724	24mm		
5497715	15mm	5497725	25mm		
5497716	16mm	5497726	26mm		
5497717	17mm	5497727	27mm		



**FORCE**

## Καρυδάκια κοντά εξάγωνα 3/4"

Κωδικός	Τύπος	Κωδικός	Τύπος	Κωδικός	Τύπος	Κωδικός	Τύπος
56517	17mm	56527	27mm	56537	37mm	56550	50mm
56518	18mm	56528	28mm	56538	38mm	56555	55mm
56519	19mm	56529	29mm	56539	39mm	56560	60mm
56520	20mm	56530	30mm	56540	40mm		
56521	21mm	56531	31mm	56541	41mm		
56522	22mm	56532	32mm	56542	42mm		
56523	23mm	56533	33mm	56543	43mm		
56524	24mm	56534	34mm	56544	44mm		
56525	25mm	56535	35mm	56545	45mm		
56526	26mm	56536	36mm	56546	46mm		



**FORCE**

## Καρυδάκια πολύγωνα 3/4"



Κωδικός	Τύπος	Κωδικός	Τύπος
56917	17mm	56934	34mm
56919	19mm	56935	35mm
56922	22mm	56936	36mm
56924	24mm	56941	41mm
56927	27mm	56946	46mm
56930	30mm	56950	50mm
56932	32mm	56955	55mm
56933	33mm	56960	60mm

## Καρυδάκια Allen 1/4"



Κωδικός	Τύπος
3243203	3X32
3243204	4X32
3243205	5X32
3243206	6X32
3243207	7X32
3243208	8X32
3243210	10X32

## Καρυδάκια Allen 1/2"



Κωδικός	Τύπος
34405504	4X55
34405505	5X55
34405506	6X55
34405507	7X55
34405508	8X55
34405509	9X55
34405510	10X55
34405512	12X55
34406514	14X65
34407017	17X70
34407019	19X70

## Καρυδάκια Allen 1/2" μήκος 100mm



Κωδικός	Τύπος
34410004	4X100
34410005	5X100
34410006	6X100
34410007	7X100
34410008	8X100
34410009	9X100
34410010	10X100
34410011	11X100
34410012	12X100
34410013	13X100
34410014	14X100

## Καρυδάκια Allen 1/2" μήκος 140mm



Κωδικός	Τύπος
34414006	6X140
34414008	8X140
34414010	10X140
34414012	12X140
34414014	14X140

## Καρυδάκια 3/4" Allen



Κωδικός	Τύπος
36408014	14X80
36408017	17X80
36408019	19X80
36408022	22X80

## Καρυδάκι μακρύ άλλεν 5mm σφαιρικό 1/2"

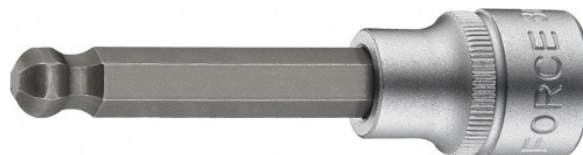

Κωδικός	Μήκος
34524005	240mm

## Καρυδάκι 1/4" Torx



Κωδικός	Τύπος
3263208	T8X32
3263209	T9X32
3263210	T10X32
3263215	T15X32
3263220	T20X32
3263225	T25X32
3263230	T30X32
3263240	T40X32

## Καρυδάκια Torx 1/4" με τρύπα

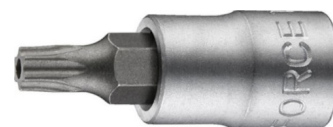

Κωδικός	Τύπος
3273208	TT8X32
3273210	TT10X32
3273215	TT15X32
3273220	TT20X32
3273225	TT25X32
3273227	TT27X32
3273230	TT30X32

## Καρυδάκια Torx 1/2"



Κωδικός	Τύπος
34605520	T20X55
34605525	T25X55
34605527	T27X55
34605530	T30X55
34605540	T40X55
34605545	T45X55
34605550	T50X55
34605555	T55X55
34605560	T60X55
34605570	T70X55
34607080	T80X70



## Καρυδάκια Torx 1/2" μακριά



Κωδικός	Τύπος
34610020	T20X100
34610025	T25X55
34610027	T27X100
34610030	T30X55
34610035	T35X100
34610040	T40X100
34610045	T45X100
34610050	T50X100
34610055	T55X100
34610060	T60X100
34610070	T70X100
34610080	T80X100



## Καρυδάκια torx 3/4"



μήκος 80 χιλιοστά

Κωδικός	Τύπος
36608060	T60
36608070	T70
36608080	T80
36608090	T90
366080100	T100

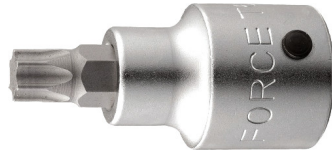

## Καρυδάκια torx θηλυκά 1/4"



Κωδικός	Τύπος	Κωδικός	Τύπος
52604	E4	52610	E10
52605	E5	52611	E11
52606	E6	52612	E12
52607	E7	52613	E14
52608	E8	52616	E16



## Καρυδάκια torx θηλυκά μακριά 1/4"

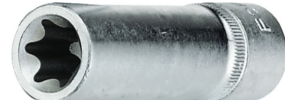

Κωδικός	Τύπος	Κωδικός	Τύπος
5265004	E4	5265010	E10
5265005	E5	5265011	E11
5265006	E6	5265012	E12
5265007	E7	5265014	E14
5265008	E8	5265016	E16



## Καρυδάκια torx θηλυκά 1/2"



Κωδικός	Τύπος	Κωδικός	Τύπος
54608	E8	54618	E18
54610	E10	54620	E20
54611	E11	54622	E22
54612	E12	54624	E24
54614	E14		
54616	E16		



## Καρυδάκια θηλυκά torx μακριά 1/2"



Μήκος 77mm



Κωδικός	Τύπος	Κωδικός	Τύπος
5467708	E8	5467718	E18
5467710	E10	5467720	E20
5467712	E12	5467722	E22
5467714	E14	5467724	E24
5467716	E16		



**Καρυδάκια πολύσφηνα 1/2"****Κωδικός Τύπος**

34805505 5X55  
 34805506 6X55  
 34805508 8X55  
 34805509 9X55  
 34805510 10X55  
 34805512 12X55  
 34805514 14X55  
 34805516 16X55

**Καρυδάκια πολύσφηνα 1/2" μακριά****Κωδικός Τύπος**

34810005 5X100  
 34810006 6X100  
 34810008 8X100  
 34810009 9X100  
 34810010 10X100  
 34810012 12X100  
 34810014 14X100  
 34810016 16X100

**Καρυδάκια Ribe (Polydrive) 1/2"****Κωδικός Τύπος**

34910005 M5X100  
 34910006 M6X100  
 34910007 M7X100  
 34910008 M8X100  
 34910009 M9X100  
 34910010 M10X100  
 34910012 M12X100  
 34910013 M13X100  
 34910014 M14X100  
 34910016 M16X100

**Καρυδάκια πολύσφηνο μακριά 1/2"****Κωδικός Τύπος Μήκος**

34812009 M9 120mm  
 34814010 M10 140mm

**Καρυδάκια Ribe (Polydrive) με σύνδεση 1/2"**

Μήκος 140mm

**Κωδικός Τύπος**

34914008 M8  
 34914009 M9  
 34914010 M10  
 34914010V M10

**Καρυδάκι πολύσφηνο με τρύπα καρέ 1/2"****Κωδικός Τύπος**

34805516T M16T

**Καρυδάκια πολύσφηνο με τρύπα καρέ 3/4"**

Μήκος 80mm

**Κωδικός Τύπος**

36808016T M16T  
 36808018T M18T

**Καρυδάκια Ribe (Polydrive) 1/2"**

Αρσενικά με τρύπα  
 Μήκος 63mm

**Κωδικός Τύπος**

34906308T M8  
 34906309T M9  
 34906312T M12



### Μίνι αερόκλειδο

- ο Καρέ 1/2"
- ο Μήκος 109mm
- ο Βάρος 1300gr
- ο Μέγ. ροπή 677Nm
- ο Στροφές 9000rpm
- ο Εισαγωγή 1/4"
- ο Κατανάλωση αέρα 135 l/min
- ο Πίεση λειτουργίας 6,2bar



**Κωδικός Τύπος**  
825411 1/2"



### Αερόκλειδο με διπλό σφυρί

- ο Καρέ 1/2"
- ο Μήκος 180mm
- ο Βάρος 2560gr
- ο Μέγ. ροπή 542Nm
- ο Στροφές 8000rpm
- ο Εισαγωγή 1/4"
- ο Κατανάλωση αέρα 119 l/min
- ο Πίεση λειτουργίας 6,2bar



**Κωδικός Τύπος**  
82541 1/2"



### Αερόκλειδο με διπλό σφυρί

- ο Καρέ 1/2"
- ο Μήκος 171mm
- ο Βάρος 1950gr
- ο Μέγ. ροπή 1054Nm
- ο Στροφές 8000rpm
- ο Εισαγωγή 1/4"
- ο Κατανάλωση αέρα 113 l/min
- ο Πίεση λειτουργίας 6,2bar



**Κωδικός Τύπος**  
82549 1/2"



### Αερόκλειδο με διπλό σφυρί

- ο Καρέ 3/4"
- ο Μήκος 234mm
- ο Βάρος 4550gr
- ο Μέγ. ροπή 1016Nm
- ο Στροφές 6500rpm
- ο Εισαγωγή 1/4"
- ο Κατανάλωση αέρα 198 l/min
- ο Πίεση λειτουργίας 6,2bar

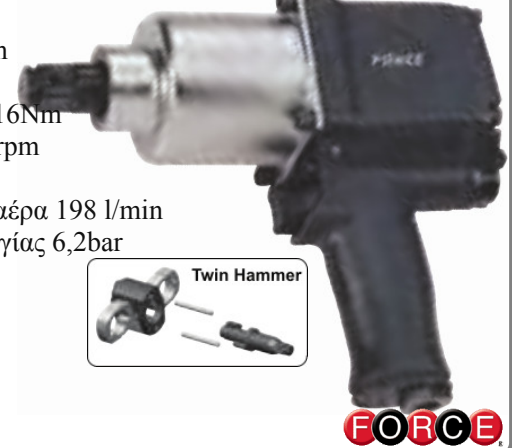

**Κωδικός Τύπος**  
82563 3/4"



### Αερόκλειδο με διπλό σφυρί

- ο Καρέ 1/2"
- ο Μήκος 183mm
- ο Βάρος 1900gr
- ο Μέγ. ροπή 813Nm
- ο Στροφές 7000rpm
- ο Εισαγωγή 1/4"
- ο Κατανάλωση αέρα 113 l/min
- ο Πίεση λειτουργίας 6,3bar



**Κωδικός Τύπος**  
70000001 1/2"



### Αερόκλειδο με διπλό σφυρί

- ο Καρέ 3/4"
- ο Μήκος 215mm
- ο Βάρος 3300gr
- ο Μέγ. ροπή 1898Nm
- ο Στροφές 5500rpm
- ο Εισαγωγή 3/8"
- ο Κατανάλωση αέρα 198 l/min
- ο Πίεση λειτουργίας 6,3bar



**Κωδικός Τύπος**  
70000002 3/4"



### Αεροκαστίανια

- ο Καρέ 1/2"
- ο Μήκος 250mm
- ο Βάρος 1200gr
- ο Μέγ. ροπή 100Nm
- ο Στροφές 160rpm
- ο Εισαγωγή 1/4"
- ο Κατανάλ. αέρα 198 l/min
- ο Πίεση λειτουργίας 6,2bar



**Κωδικός Τύπος**  
82441 1/2"



### Σετ καρυδάκια αέρος 1/2" 10 τεμάχια

- 11, 12, 13,  
14, 16, 17,  
19, 21, 22, 24



**Κωδικός Τύπος**  
4109 Κοντά  
4107 Μακριά





## Καρυδάκια αερόκλειδου 1/2"



Κωδικός	Τύπος	Κωδικός	Τύπος	Κωδικός	Τύπος	Κωδικός	Τύπος
44510	10	44519	19	44528	28	4453.8	3/8"
44511	11	44520	20	44529	29	4451.2	1/2"
44512	12	44521	21	44530	30	4453.4	3/4"
44513	13	44522	22	44532	32	4455.8	5/8"
44514	14	44523	23	44533	33	4457.16	7/16"
44515	15	44524	24	44534	34	4459.16	9/16"
44516	16	44525	25	44536	36	4457.8	7/8"
44517	17	44526	26			4451.0	1"
44518	18	44527	27			4451.1.8	1 1/8"



FORCE

## Καρυδάκια αερόκλειδου 1/2" μακριά



Κωδικός	Τύπος	Κωδικός	Τύπος	Κωδικός	Τύπος
4458510	10	4458519	19	4458528	28
4458511	11	4458520	20	4458529	29
4458512	12	4458521	21	4458530	30
4458513	13	4458522	22	4458532	32
4458514	14	4458523	23	4458533	33
4458515	15	4458524	24	4458534	34
4458516	16	4458525	25	4458536	36
4458517	17	4458526	26		
4458518	18	4458527	27		



FORCE

## Καρυδάκια αέρος θηλυκά Torx 3/4"



Για μπουλόνια κυλινδροκεφαλής βαρέων οχημάτων MAN

Για μπουλόνια καλύματος στροφαλοφόρου βαρέων οχημάτων SCANIA

Κωδικός	Τύπος	Μήκος
46611018	E18	110mm
46611020	E20	110mm
46611022	E22	110mm
46611024	E24	110mm
46611028	E28	110mm



FORCE

## Καρυδάκια αέρος κοντά πολύγωνα μαύρα 3/4"



Κωδικός	Τύπος	Κωδικός	Τύπος
46817	17mm	46832	32mm
46819	19mm	46834	34mm
46821	21mm	46835	35mm
46822	22mm	46836	36mm
46824	24mm	46838	38mm
46827	27mm	46841	41mm
46830	30mm		



FORCE

## Καρυδάκια αερόκλειδου 3/4"



Κωδικός	Τύπος	Κωδικός	Τύπος	Κωδικός	Τύπος
46517	17mm	46532	32mm	46546	46mm
46518	18mm	46533	33mm	46547	47mm
46519	19mm	46534	34mm	46548	48mm
46521	21mm	46535	35mm	46550	50mm
46522	22mm	46536	36mm	46552	52mm
46523	23mm	46537	37mm	46554	54mm
46524	24mm	46538	38mm	46555	55mm
46525	25mm	46540	40mm	46557	57mm
46526	26mm	46541	41mm	46558	58mm
46527	27mm	46542	42mm	46560	60mm
46528	28mm	46543	43mm	46565	65mm
46529	29mm	46544	44mm		
46530	30mm	46545	45mm		



FORCE

## Καρυδάκια αερόκλειδου 3/4" μακριά

Κωδικός	Τύπος	Κωδικός	Τύπος	Κωδικός	Τύπος
46510017	17mm	46510032	32mm	46510046	46mm
46510018	18mm	46510033	33mm	46510050	50mm
46510019	19mm	46510034	34mm	46510055	55mm
46510022	22mm	46510036	36mm	46510060	60mm
46510024	24mm	46510038	38mm	46510065	65mm
46510027	27mm	46510040	40mm		
46510030	30mm	46510041	41mm		



FORCE

## Καρυδάκια αερόκλειδου 1"

Κωδικός	Τύπος	Κωδικός	Τύπος	Κωδικός	Τύπος
48519	19mm	48536	36mm	48570	70mm
48522	22mm	48538	38mm	48575	75mm
48524	24mm	48540	40mm	48580	80mm
48527	27mm	48541	41mm	48585	85mm
48528	28mm	48546	46mm	48590	90mm
48530	30mm	48550	50mm	48595	95mm
48532	32mm	48555	55mm		
48533	33mm	48560	60mm		
48534	34mm	48565	65mm		



FORCE

## Καρυδάκια αερόκλειδου 1" μακριά

Κωδικός	Τύπος
48510024	24mm
48510027	27mm
48510028	28mm
48510030	30mm
48510032	32mm
48510033	33mm
48510036	36mm
48510038	38mm
48510041	41mm
48510046	46mm
48510050	50mm
48510055	55mm
48510060	60mm
48510065	65mm
48510070	70mm



FORCE

## Συστολές αέρος

Κωδικός	Τύπος
80934MPB	3/8"FX1/2"M
80943MPB	1/2"FX3/8"M
80946MPB	1/2"FX3/4"M
80964MPB	3/4"FX1/2"M
80968MPB	3/4"FX1"M
80986MPB	1"FX3/4"M
809812MPB	1"FX1 1/2"M



FORCE

## Καρυδάκια αέρος 3/4" σε ίντσες

Κωδικός	Τύπος
46513.16	13/16"
46515.16	15/16"
4651.0	1"
4651.3.16	1 3/16"



FORCE

## Καρυδάκια εξάγωνα μπουλονόκλειδου καρέ 1/2"

Με επικάλυψη teflon για να μην πληγώνουν τις ζάντες.  
Μήκος 85mm



Κωδικός	Τύπος
4458517C	17mm
4458519C	19mm
4458521C	21mm

FORCE

## Σπαστά για καρυδάκια αέρος

Κωδικός	Τύπος
80541MPB	1/2'
80561MPB	3/4'



FORCE

**Καρυδάκια αερόκλειδου πολύγωνο με καρέ 1/2"**

Κωδικός	Τύπος
44810	10mm
44813	13mm
44817	17mm
44818	18mm
44819	19mm
44821	21mm
44822	22mm
44824	24mm

**Καρυδάκια αερόκλειδου πολύγωνο με καρέ 1/2"**

Μήκος 85mm



Κωδικός	Τύπος	Κωδικός	Τύπος
4488513	13mm	4488527	27mm
4488517	17mm	4488530	30mm
4488519	19mm	4488532	32mm
4488521	21mm	4488534	34mm
4488522	22mm	4488535	35mm
4488524	24mm	4488536	36mm

**Καρυδάκια αερόκλειδου τετράγωνα 3/4"**

Μήκος 50mm



Κωδικός	Επαναφορά
46117	17mm
46119	19mm
46121	21mm

**Καρυδάκια αερόκλειδου εξάγωνο με καρέ 1 1/2"**

Κωδικός	Τύπος
4125100	100mm
4125105	105mm
4125110	110mm

**Καρυδάκια αερόκλειδου τύπου Locknut (KM)**

1/2"



Κωδικός	Επαναφορά
9TS4KM04	32mm
9TS4KM05	38mm
9TS4KM06	45mm
9TS4KM07	55mm

**Καρυδάκια αερόκλειδου τύπου Locknut (KM)**

3/4"



Κωδικός	Επαναφορά
9TS6KM08	58mm
9TS6KM09	65mm
9TS6KM10	70mm
9TS6KM11	75mm
9TS6KM12	80mm
9TS6KM13	85mm
9TS6KM14	90mm

**Καρυδάκι εξαέρωσης αντλιών με καρέ 1/2"**

Κωδικός	Τύπος	Μήκος
44322	22mm	85mm
44327	27mm	85mm
44315022	22mm	150mm

**Καρυδάκι αέρος 1/2" σε ίντσες**

Εξάγωνο



Κωδικός	Τύπος
4453.8	3/8"
4457.8	7/8"



**Εξολκέας τροχαλίας μάντα**Για VW GOLF, VENTO, PASSAT, AUDI A3,  
VOLVO

Κωδικός	Τύπος
67402	Για κλειδί 17mm

**Προεκτάσεις αέρος 1/2"**

Κωδικός	Τύπος
8044075MPB	75mm
8044125MPB	125mm
8044250MPB	250mm

**Προεκτάσεις αέρος 3/4"**

Κωδικός	Τύπος
8046100MPB	100mm
8046175MPB	175mm
8046250MPB	250mm
8046330MPB	330mm

**Προεκτάσεις αέρος 1"**

Κωδικός	Τύπος
8048100MPB	100mm
8048175MPB	175mm
8048250MPB	250mm
8048330MPB	330mm



**Διαμαντοτρώπανα OPAL**

Κωδικός	Τύπος	Κωδικός	Τύπος
190000030	3X70	190000100	10X120
190000040	4X75	190000120	12X150
190000050	5X85	190000140	14X150
190000060	6X100	190000160	16X150
190000070	7X100	190000200	20X160
190000080	8X120		

**Διαμαντοτρώπανα OPAL μακριά**

Κωδικός	Τύπος	Κωδικός	Τύπος
29005150	5X150	29014200	14X200
29006150	6X150	29016200	16X200
29006200	6X200		
29008200	8X200		
29010200	10X200		
29012200	12X200		

**Διαμαντοτρώπανα TURBOKEIL**

Κωδικός	Τύπος	Κωδικός	Τύπος
258000040	4X75	258000100	10X120
258000050	5X85	258000120	12X150
258000060	6X100	258000140	14X150
258000070	7X100	258000160	16X150
258000080	8X120		

**Διαμαντοτρώπανα γρανίτη PRIMUS**

Κωδικός	Τύπος	Κωδικός	Τύπος
15404075	4X75	15414150	14X150
15405085	5X85	15416150	16X150
15406100	6X100	15418160	18X160
15408120	8X120	15420160	20X160
15410120	10X120		
15412150	12X150		

**Διαμαντοτρώπανα GOLDCRAFT**

Χωρίς κρούση. Για όλα τα υλικά.  
Μεγάλη απόδοση σε μάρμαρα.

Κωδικός	Τύπος	Κωδικός	Τύπος
11903070	3X70	11910120	10X120
11904075	4X75	21910200	10X200
11905085	5X85	11912150	12X150
21905150	5X150	21912200	12X200
11906100	6X100	11914150	14X150
11965250	6,5X250	11916150	16X150
21906150	6X150		
11907100	7X100		
11908120	8X120		
21908200	8X200		

**Διαμαντοτρώπανα KEILER**

Κωδικός	Τύπος	Κωδικός	Τύπος
150000060	6X150	600000120	12X600
200000060	6X200	400000140	14X400
300000060	6X300	600000140	14X600
400000060	6X400	400000160	16X400
200000080	8X200	600000160	16X600
400000080	8X400	600000180	18X160
200000100	10X200	400000180	18X400
400000100	10X400	600000180	18X600
600000100	10X600	400000200	20X400
200000120	12X200	600000200	20X600
400000120	12X400		

**Τρωπάνια χωρίς κρούση**

Profi multicut



Κωδικός	Τύπος
0017200400100	4X120mm
0017200500100	5X120mm
0017200600100	6X120mm
0017200700100	7X120mm
0017200800100	8X120mm
0017201000100	10X120mm
0017201200100	12X120mm

**Τρωπάνια χωρίς κρούση με καρέ 1/4"**

Profi multicut



Κωδικός	Τύπος
0027200400100	4mm
0027200500100	5mm
0027200600100	6mm
0027200800100	8mm
0027201000100	10mm



**Διαμαντοτρώπανα μακριά**

Profi multicut

**Κωδικός****Τύπος**

0072900650100 6,5X200mm

**alpen**  
drill better.**Διαμαντοτρώπανα μακριά SDS Plus**

Profi multicut

**Κωδικός****Τύπος**

0053900650100 6,5X260mm

**alpen**  
drill better.**Διαμαντοτρώπανα χωρίς κρούση HARDTEC****Κωδικός****Τύπος**

168000040 4X40X75mm

168000050 5X50X85mm

168000060 6X60X100mm

168000080 8X75X120mm

168000100 10X75X120mm

**KEIL****Διαμαντοτρώπανα γρανιτοπλακιδίων****Κωδικός****Τύπος****Κωδικός****Τύπος**

786090050 5X67 786090150 15X80

786090060 6X67 786090200 20X70

786090080 8X80 786090250 25X70

786090100 10X80 786090300 30X70

786090120 12X80

**KEIL****Τρωπάνια SDS-Plus MS5 TURBOKEIL****Κωδικός****Τύπος****Κωδικός****Τύπος****Κωδικός****Τύπος**

253040110 4X110 253080600 8X600 253160165 16X160

253050110 5X110 253100110 10X110 253160215 16X210

253050160 5X160 253100160 10X160 253160265 16X260

253055110 5,5X110 253100210 10X210 253160450 16X450

253055160 5,5X160 253100260 10X260 253160600 16X600

253060110 6X110 253100310 10X310 253161000 16X1000

253060160 6X160 253100460 10X460 253180300 18X300

253060210 6X210 253100600 10X600 253180450 18X450

253060260 6X260 253101000 10X1000 253180600 18X600

253060360 6X360 253120160 12X160 253181000 18X1000

253060460 6X460 253120210 12X210 253200300 20X300

253065160 6,5X160 253120260 12X260 253200450 20X450

253065210 6,5X210 253120310 12X310 253200600 20X600

253065260 6,5X260 253120450 12X450 253201000 20X1000

253070110 7X110 253120600 12X600 253220250 22X250

253070160 7X160 253121000 12X1000 253220450 22X450

253080110 8X110 253140165 14X165 253220600 22X600

253080160 8X160 253140210 14X210 253221000 22X1000

253080210 8X210 253140265 14X265 253240250 24X250

253080260 8X260 253140450 14X450 253240450 24X450

253080310 8X310 253140600 14X600 253250450 25X450

253080460 8X460 253141000 14X1000

**KEIL****Διαμαντοτρώπανα γρανιτοπλακιδίων**Ειδική κοπή  
1000/3000rpm**Κωδικός****Τύπος**

56752 6mm

56753 8mm

56754 10mm

56755 12mm

56756 14mm

**Kapriol****Τρωπάνια τετράκοπα SDS-Plus XPRO****Κωδικός****Τύπος****Κωδικός****Τύπος**

251060160 6X100X160mm 251140160 14X100X160mm

251060210 6X150X210mm 251140210 14X100X210mm

251080160 8X100X160mm 251160260 16X200X260mm

251080210 8X150X210mm 251160450 16X400X450mm

251100160 10X100X160mm 251180250 18X200X250mm

251100210 10X150X210mm 251180450 18X400X450mm

251120160 12X100X160mm 251200250 20X200X250mm

251120210 12X150X210mm 251200450 20X400X450mm

**KEIL****Διαμαντοτρώπανα βιδολόγων**

KEILBIT MULTICUT

**Κωδικός****Τύπος**

166000030 3X75

166000040 4X85

166000050 5X95

166000060 6X100

166000080 8X120

166000100 10X120

166000120 12X151

**KEIL**

**Τρωπάνια SDS-Plus GOLDCRAFT**

Χωρίς κρούση. Για όλα τα υλικά.  
Μεγάλη απόδοση σε μάρμαρα.

Κωδικός	Τύπος
119255001	6X160
119255002	8X160
119255003	8X210
119255004	10X160
119255005	10X260
119255006	12X165
119255007	12X260
119255008	14X260

**Τρωπάνια SDS-Plus TURBOKEIL**

Κωδικός	Τύπος	Κωδικός	Τύπος
252116250	16X250	252124450	24X450
252118250	18X250	252125450	25X450
252120250	20X250	252128450	28X450
252116450	16X450	252130450	30X450
252118450	18X450		
252120450	20X450		
252122450	22X450		

**Τρωπάνια SDS-Plus τεράκοπα F8**

Κωδικός	Τύπος	Κωδικός	Τύπος
M81616010050	Ø5X160X100mm	M84601000100	Ø10X310X250mm
M826210150060	Ø6X210X150mm	M81616010012	Ø12X160X100mm
M836260200060	Ø6X260X200mm	M826210150012	Ø12X210X150mm
M81616010065	Ø6,5X160X100mm	M836260200120	Ø12X260X200mm
M82621015065	Ø6,5X210X150mm	M846012001000	Ø12X310X250mm
M836260200065	Ø6,5X260X200mm	M816014001000	Ø14X160X100mm
M81616010007	Ø7X160X100mm	M826210150014	Ø14X210X150mm
M81616010008	Ø8X160X100mm	M836260200140	Ø14X260X200mm
M836280210150	Ø8X210X150mm	M846014001000	Ø14X310X250mm
M836260200080	Ø8X260X200mm	M816016001000	Ø16X160X100mm
M846008001000	Ø8X310X250mm	M826210150016	Ø16X210X150mm
M81616010010	Ø10X160X100mm	M836016001000	Ø16X260X200mm
M826210150010	Ø10X210X150mm	M846016001000	Ø16X310X250mm
M836260200100	Ø10X260X200mm	M83625020018	Ø18X250X200mm
		M83625020020	Ø20X250X200mm

**Διαμαντοτρώπανα SDS MAX**

Κωδικός	Τύπος	Κωδικός	Τύπος	Κωδικός	Τύπος	Κωδικός	Τύπος
270160340	16X340	270201320	20X1320	270250920	25X920	270321320	32X1320
270160540	16X540	270220320	22X320	270251320	25X1320	270350570	35X570
270160940	16X940	270220520	22X520	270280370	28X370	270380570	38X570
270180340	18X340	270220920	22X920	270160570	28X570	270400570	40X570
270180540	18X540	270221320	22X1320	270280370	30X370	270400920	40X920
270180940	18X940	270240320	24X320	270300570	30X570	270401320	40X1320
270200320	20X320	270240520	24X520	270320370	32X370	270450570	45X570
270200520	20X520	270250320	25X320	270320570	32X570	270500570	50X570
270200920	20X920	270250520	25X520	270320920	32X920		

**Διαμαντοκεφαλές SDS-MAX**

Κωδικός	Τύπος
269550550	55mm
269650550	65mm
269800550	80mm



## Διαμαντοτρώπανα SDS-Plus τεράκοπα **NEO**

Power-4ce



Κωδικός	Τύπος	Μήκος	Κωδικός	Τύπος	Μήκος	Κωδικός	Τύπος	Μήκος
267050110	5mm	110mm	267080310	8mm	310mm	267120400	12mm	400mm
267050160	5mm	160mm	267100160	10mm	160mm	267140160	14mm	160mm
267060110	6mm	110mm	267100210	10mm	210mm	267140200	14mm	200mm
267060160	6mm	160mm	267100260	10mm	260mm	267140250	14mm	250mm
267060210	6mm	210mm	267100310	10mm	310mm	267160200	16mm	200mm
267060260	6mm	260mm	267120160	12mm	160mm	267160250	16mm	250mm
267080160	8mm	160mm	267120210	12mm	210mm	267160300	16mm	300mm
267080210	8mm	210mm	267120260	12mm	260mm			
267080260	8mm	260mm	267120310	12mm	310mm			



### Ποτηροκορώνες σκέτες με κρούση

για μπετόν - τούβλο  
Πάσο: M16



Κωδικός	Τύπος	Κωδικός	Τύπος
710000025	Ø25	711000060	Ø60
710000030	Ø30	711000065	Ø65
710000035	Ø35	711000068	Ø68
710000040	Ø40	711000080	Ø80
710000045	Ø45	711000090	Ø90
710000050	Ø50	711000100	Ø100
711000045	Ø55		



### Ποτηροκορώνες σκέτες χωρίς κρούση

για δομικά υλικά  
Πάσο: M16



Κωδικός	Τύπος
719000025	Ø25X73
719000030	Ø30X73
719000035	Ø35X73
719000040	Ø40X73
719000045	Ø45X73
719000050	Ø50X73
719000060	Ø60X73
719000068	Ø68X73



### Οδηγοί για ποτηροκορώνες εξάγωνοι

Πάσο: M16



Κωδικός	Τύπος
712080120	80mm
712200120	200mm
712350120	350mm



### Οδηγοί για ποτηροκορώνες SDS-Plus

Πάσο: M16



Κωδικός	Τύπος
713080120	105mm
713200120	200mm
713350120	350mm



### Τρυπάνι πιλότος για ποτηροκορώνες

για δομικά υλικά



Κωδικός	Τύπος
719080120	8X120mm



### Σετ αδαμαντοκορώνες

33-53-67-73mm



Κωδικός
715033073



**Τρυπάνια αέρος μαύρα DIN338**

Κωδικός	Τύπος	Κωδικός	Τύπος	Κωδικός	Τύπος	Κωδικός	Τύπος
333800100	Ø1mm	333800500	Ø5mm	333801000	Ø10mm	333801600	Ø16mm
333800150	Ø1,5mm	333800520	Ø5,2mm	333801050	Ø10,5mm	333801650	Ø16,5mm
333800200	Ø2mm	333800550	Ø5,5mm	333801100	Ø11mm	333801700	Ø17mm
333800250	Ø2,5mm	333800570	Ø5,7mm	333801150	Ø11,5mm	333801750	Ø17,5mm
333800300	Ø3mm	333800600	Ø6mm	333801200	Ø12mm	333801800	Ø18mm
333800320	Ø3,2mm	333800650	Ø6,5mm	333801250	Ø12,5mm	333801850	Ø18,5mm
333800350	Ø3,5mm	333800700	Ø7mm	333801300	Ø13mm	333801900	Ø19mm
333800370	Ø3,7mm	333800750	Ø7,5mm	333801350	Ø13,5mm	333801950	Ø19,5mm
333800400	Ø4mm	333800800	Ø8mm	333801400	Ø14mm	333802000	Ø20mm
333800420	Ø4,2mm	333800850	Ø8,5mm	333801450	Ø14,5mm		
333800450	Ø4,5mm	333800900	Ø9mm	333801500	Ø15mm		
333800470	Ø4,7mm	333800950	Ø9,5mm	333801550	Ø15,5mm		

**PTG****Τρυπάνια αέρος μαύρα με άξονα 13mm**

Κωδικός	Τύπος	Κωδικός	Τύπος
333131350	Ø13,5mm	333131950	Ø19,5mm
333131400	Ø14mm	333132000	Ø20mm
333131450	Ø14,5mm	333132200	Ø22mm
333131500	Ø15mm	333132300	Ø23mm
333131550	Ø15,5mm	333132400	Ø24mm
333131600	Ø16mm	333132500	Ø25mm
333131650	Ø16,5mm	333132600	Ø26mm
333131700	Ø17mm	333132700	Ø27mm
333131750	Ø17,5mm	333132800	Ø28mm
333131800	Ø18mm	333132900	Ø29mm
333131850	Ø18,5mm	333133000	Ø30mm
333131900	Ø19mm		

**PTG****Τρυπάνια μαύρα μακριά DIN340**

Κωδικός	Τύπος	Κωδικός	Τύπος
334000200	Ø2mm	334000800	Ø8mm
334000250	Ø2,5mm	334000850	Ø8,5mm
334000300	Ø3mm	334000900	Ø9mm
334000350	Ø3,5mm	334000950	Ø9,5mm
334000400	Ø4mm	334001000	Ø10mm
334000450	Ø4,5mm	334001050	Ø10,5mm
334000500	Ø5mm	334001100	Ø11mm
334000550	Ø5,5mm	334001150	Ø11,5mm
334000600	Ø6mm	334001200	Ø12mm
334000650	Ø6,5mm	334001250	Ø12,5mm
334000700	Ø7mm	334001300	Ø13mm
334000750	Ø7,5mm		

**PTG****Τρυπάνια με κωνικό morse DIN345**

Κωδικός	Τύπος	Κωδικός	Τύπος	Κωδικός	Τύπος	Κωδικός	Τύπος
334501600	Ø16mm	334502200	Ø22mm	334502800	Ø28mm	334503400	Ø34mm
334501650	Ø16,5mm	334502250	Ø22,5mm	334502850	Ø28,5mm	334503450	Ø34,5mm
334501700	Ø17mm	334502300	Ø23mm	334502900	Ø29mm	334503500	Ø35mm
334501750	Ø17,5mm	334502350	Ø23,5mm	334502950	Ø29,5mm	334503550	Ø35,5mm
334501800	Ø18mm	334502400	Ø24mm	334503000	Ø30mm	334503600	Ø36mm
334501850	Ø18,5mm	334502450	Ø24,5mm	334503050	Ø30,5mm	334503650	Ø36,5mm
334501900	Ø19mm	334502500	Ø25mm	334503100	Ø31mm	334503700	Ø37mm
334501950	Ø19,5mm	334502550	Ø25,5mm	334503150	Ø31,5mm	334503750	Ø37,5mm
334502000	Ø20mm	334502600	Ø26mm	334503200	Ø32mm	334503800	Ø38mm
334502050	Ø20,5mm	334502650	Ø26,5mm	334503250	Ø32,5mm		
334502100	Ø21mm	334502700	Ø27mm	334503300	Ø33mm		
334502150	Ø21,5mm	334502750	Ø27,5mm	334503350	Ø33,5mm		

**PTG**

**Τρυπάνια αέρος HSS Sprint Master DIN338**

γρήγορα &amp; εύκαμπτα



Κωδικός	Τύπος	Κωδικός	Τύπος
A338H0100	Ø1mm	A338H0750	Ø7,5mm
A338H0150	Ø1,5mm	A338H0800	Ø8mm
A338H0200	Ø2mm	A338H0850	Ø8,5mm
A338H0250	Ø2,5mm	A338H0900	Ø9mm
A338H0300	Ø3mm	A338H0950	Ø9,5mm
A338H0350	Ø3,5mm	A338H1000	Ø10mm
A338H0400	Ø4mm	A338H1050	Ø10,5mm
A338H0450	Ø4,5mm	A338H1100	Ø11mm
A338H0500	Ø5mm	A338H1150	Ø11,5mm
A338H0550	Ø5,5mm	A338H1200	Ø12mm
A338H0600	Ø6mm	A338H1250	Ø12,5mm
A338H0650	Ø6,5mm	A338H1300	Ø13mm
A338H0700	Ø7mm		

**Τρυπάνια κοντά με εξάγωνο καρέ ¼"**

Κωδικός	Τύπος	Κωδικός	Τύπος
67110	1mm	67160	6mm
67115	1,5mm	67165	6,5mm
67120	2mm	67170	7mm
67125	2,5mm	67175	7,5mm
67130	3mm	67180	8mm
67135	3,5mm	67185	8,5mm
67140	4mm	67190	9mm
67145	4,5mm	67195	9,5mm
67150	5mm	67198	10mm
67155	5,5mm		

**Τρυπάνια κοβαλτίου 5% DIN338**

Κωδικός	Τύπος	Κωδικός	Τύπος	Κωδικός	Τύπος	Κωδικός	Τύπος
233850030	Ø0,3mm	233850320	Ø3,2mm	233850610	Ø6,1mm	233850900	Ø9mm
233850040	Ø0,4mm	233850330	Ø3,3mm	233850620	Ø6,2mm	233850910	Ø9,1mm
233850050	Ø0,5mm	233850340	Ø3,4mm	233850630	Ø6,3mm	233850920	Ø9,2mm
233850060	Ø0,6mm	233850350	Ø3,5mm	233850640	Ø6,4mm	233850930	Ø9,3mm
233850070	Ø0,7mm	233850360	Ø3,6mm	233850650	Ø6,5mm	233850940	Ø9,4mm
233850080	Ø0,8mm	233850370	Ø3,7mm	233850660	Ø6,6mm	233850950	Ø9,5mm
233850090	Ø0,9mm	233850380	Ø3,8mm	233850670	Ø6,7mm	233850960	Ø9,6mm
233850100	Ø1mm	233850390	Ø3,9mm	233850680	Ø6,8mm	233850970	Ø9,7mm
233850110	Ø1,1mm	233850400	Ø4mm	233850690	Ø6,9mm	233850980	Ø9,8mm
233850120	Ø1,2mm	233850410	Ø4,1mm	233850700	Ø7mm	233850990	Ø9,9mm
233850130	Ø1,3mm	233850420	Ø4,2mm	233850710	Ø7,1mm	233851000	Ø10mm
233850140	Ø1,4mm	233850430	Ø4,3mm	233850720	Ø7,2mm	233851020	Ø10,2mm
233850150	Ø1,5mm	233850440	Ø4,4mm	233850730	Ø7,3mm	233851030	Ø10,3mm
233850160	Ø1,6mm	233850450	Ø4,5mm	233850740	Ø7,4mm	233851050	Ø10,5mm
233850170	Ø1,7mm	233850460	Ø4,6mm	233850750	Ø7,5mm	233851100	Ø11mm
233850180	Ø1,8mm	233850470	Ø4,7mm	233850760	Ø7,6mm	233851150	Ø11,5mm
233850190	Ø1,9mm	233850480	Ø4,8mm	233850770	Ø7,7mm	233851200	Ø12mm
233850200	Ø2mm	233850490	Ø4,9mm	233850780	Ø7,8mm	233851220	Ø12,2mm
233850210	Ø2,1mm	233850500	Ø5mm	233850790	Ø7,9mm	233851250	Ø12,5mm
233850220	Ø2,2mm	233850510	Ø5,1mm	233850800	Ø8mm	233851300	Ø13mm
233850230	Ø2,3mm	233850520	Ø5,2mm	233850810	Ø8,1mm	233851350	Ø13,5mm
233850240	Ø2,4mm	233850530	Ø5,3mm	233850820	Ø8,2mm	233851400	Ø14mm
233850250	Ø2,5mm	233850540	Ø5,4mm	233850830	Ø8,3mm	233851450	Ø14,5mm
233850260	Ø2,6mm	233850550	Ø5,5mm	233850840	Ø8,4mm	233851500	Ø15mm
233850270	Ø2,7mm	233850560	Ø5,6mm	233850850	Ø8,5mm	233851550	Ø15,5mm
233850280	Ø2,8mm	233850570	Ø5,7mm	233850860	Ø8,6mm	233851600	Ø16mm
233850290	Ø2,9mm	233850580	Ø5,8mm	233850870	Ø8,7mm		
233850300	Ø3mm	233850590	Ø5,9mm	233850880	Ø8,8mm		
233850310	Ø3,1mm	233850600	Ø6mm	233850890	Ø8,9mm		



**Τρυπάνια κοβαλτίου 5% με άξονα 13mm**

Κωδικός	Τύπος	Κωδικός	Τύπος
253131350	Ø13,5mm	253131750	Ø17,5mm
253131400	Ø14mm	253131800	Ø18mm
253131450	Ø14,5mm	253131850	Ø18,5mm
253131500	Ø15mm	253131900	Ø19mm
253131550	Ø15,5mm	253131950	Ø19,5mm
253131600	Ø16mm	253132000	Ø20mm
253131650	Ø16,5mm		
253131700	Ø17mm		

**PTG****Τρυπάνια κοβαλτίου 8% DIN338**

Κωδικός	Τύπος	Κωδικός	Τύπος
283380300	Ø3mm	283380700	Ø7mm
283380350	Ø3,5mm	283380750	Ø7,5mm
283380400	Ø4mm	283380800	Ø8mm
283380450	Ø4,5mm	283380850	Ø8,5mm
283380500	Ø5mm	283380900	Ø9mm
283380550	Ø5,5mm	283380950	Ø9,5mm
283380600	Ø6mm	283381000	Ø10mm
283380650	Ø6,5mm		

**PTG****Τρυπάνια κοβαλτίου 5% μακριά DIN340**

Κωδικός	Τύπος	Κωδικός	Τύπος	Κωδικός	Τύπος	Κωδικός	Τύπος
234000200	Ø2mm	234000500	Ø5mm	234000800	Ø8mm	234001100	Ø11mm
234000250	Ø2,5mm	234000550	Ø5,5mm	234000850	Ø8,5mm	234001150	Ø11,5mm
234000300	Ø3mm	234000600	Ø6mm	234000900	Ø9mm	234001200	Ø12mm
234000350	Ø3,5mm	234000650	Ø6,5mm	234000950	Ø9,5mm	234001250	Ø12,5mm
234000400	Ø4mm	234000700	Ø7mm	234001000	Ø10mm	234001300	Ø13mm
234000450	Ø4,5mm	234000750	Ø7,5mm	234001050	Ø10,5mm		

**PTG****Τρυπάνια αέρος πολύ μακριά DIN1869**

Κωδικός	Τύπος	Κωδικός	Τύπος	Κωδικός	Τύπος
228690300	Ø3X190mm	218690600	Ø6X205mm	228690850	Ø8,5X305mm
228690350	Ø3,5X210mm	228690600	Ø6X260mm	228690900	Ø9X320mm
228690400	Ø4X220mm	228690650	Ø6,5X275mm	228690950	Ø9,5X320mm
228690450	Ø4,5X235mm	228690700	Ø7X290mm	228691000	Ø10X340mm
228690500	Ø5X245mm	228690750	Ø7,5X290mm		
228690550	Ø5,5X260mm	228690800	Ø8X305mm		

**PTG****Τρυπάνια καρβιδίου DIN6539**

Κωδικός	Τύπος	Κωδικός	Τύπος
296530100	Ø1	296530600	Ø6
296530150	Ø1,5	296530650	Ø6,5
296530200	Ø2	296530700	Ø7
296530250	Ø2,5	296530750	Ø7,5
296530300	Ø3	296530800	Ø8
296530350	Ø3,5	296530850	Ø8,5
296530400	Ø4	296530900	Ø9
296530450	Ø4,5	296530950	Ø9,5
296530500	Ø5	296531000	Ø10
296530550	Ø5,5		

**PTG****Τρυπάνια αέρος με καρέ 1/4"**

HSS Super



Κωδικός	Τύπος
0095200200100	2mm
0095200300100	3mm
0095200400100	4mm
0095200500100	5mm
0095200600100	6mm
0095200800100	8mm

 drill better.  
**alpen**

### Τρυπάνια για hardox



Κωδικός	Διατομή	Τύπος	Κωδικός	Διατομή	Τύπος
234581600	Ø16	MK2	234582700	Ø27	MK4
234581800	Ø18	MK2	234582800	Ø28	MK4
234582000	Ø20	MK3	234582900	Ø29	MK4
234582200	Ø22	MK3	234583000	Ø30	MK4
234582400	Ø24	MK3	234583100	Ø31	MK4
234582500	Ø25	MK3	234583200	Ø32	MK4
234582600	Ø26	MK3			

**PTG**

### Κεντραδόροι τόννου



Κωδικός	Τύπος
233300200	2mm
233300250	2,5mm
233300315	3,15mm
233300400	4mm
233300500	5mm

**PTG**

### Φρεζάκια κοβαλτίου



Κωδικός	Τύπος
3533520800	8mm
3533521000	10mm
3533521240	12,40mm
3533501650	16,50mm
3533502050	20,50mm
3533502500	25mm
3533503100	31mm

**PTG**

### Τρυπάνια ξεπονταρίσματος DIN1897



Κωδικός	Τύπος
218980600	6X66mm Κοβαλτίου
218980800	8mm Κοβαλτίου
218960800	8mm Τιτανίου

**PTG**

### Τρυπάνια κοβαλτίου 5% DIN1412C **ΝΕΟ**

Uni-Fl Ιδανικά για Inox λόγω διαφορετικής ελίκωσης



Κωδικός	Τύπος	Κωδικός	Τύπος
PTG-33890300	3mm	PTG-33890700	7mm
PTG-33890350	3,5mm	PTG-33890750	7,5mm
PTG-33890400	4mm	PTG-33890800	8mm
PTG-33890450	4,5mm	PTG-33890850	8,5mm
PTG-33890500	5mm	PTG-33890900	9mm
PTG-33890550	5,5mm	PTG-33890950	9,5mm
PTG-33890600	6mm	PTG-33891000	10mm
PTG-33890650	6,5mm		

**PTG**

### Τρυπάνια αέρος ράσπα

Universal



Κωδικός	Τύπος
72106	6mm
72108	8mm

**alpen** drill better.

### Φρεζάκια ξύλου



Κωδικός	Τύπος
2101-005	5mm
2101-006	6mm
2101-007	7mm

**TopMan**

**Τρυπάνια για γυαλί**

Κωδικός	Τύπος	Κωδικός	Τύπος
130000030	3X58	130000080	8X78
130000040	4X58	130000090	9X98
130000050	5X58	130000100	10X98
130000055	5,5X58	130000120	12X98
130000060	6X58		
130000070	7X78		

**Τρυπάνια κεραμικών**

Keramo Extreme



Κωδικός	Τύπος
0030000500100	5mm
0030000600100	6mm
0030000800100	8mm
0030001000100	10mm
0030001200100	12mm

**Τρυπάνια κεραμικών**

Κωδικός	Τύπος
151018040	4X75
151018050	5X85
151018060	6X100
151018080	8X120
151018100	10X120
151018120	12X150
151017140	14X150

**Τρυπάνια ξύλου**

Κωδικός	Τύπος	Κωδικός	Τύπος
18003061	3X61	18014151	14X151
18004075	4X75	18016160	16X160
18005086	5X86	18018180	18X180
18006093	6X93	18020200	20X200
18008117	8X117	18022205	22X205
18010120	10X120	18024215	24X215
18012151	12X151		

**Τρυπάνια μεντεσέδων**

Κωδικός	Τύπος
183000260	26X90
183000280	28X90
183000300	30X90
183000350	35X90
183000400	40X90

**Τρυπάνια ξύλου μακριά**

Κωδικός	Τύπος	Κωδικός	Τύπος
350060400	6X400	350120600	12X600
350060600	6X600	350140400	14X400
350080400	8X400	350140600	14X600
350080600	8X600	350160400	16X400
350100400	10X400	350160600	16X600
350100600	10X600	350180400	18X400
350120400	12X400	350200400	20X400

**Τρυπάνια ξύλου μακριά ελικοειδή**

Κωδικός	Τύπος
181080450	8X460
181100450	10X460
181120450	12X460
181140450	14X460
181160450	16X460

**Τρυπάνια ξύλου φτερού**

Κωδικός	Τύπος	Κωδικός	Τύπος
185080150	8X150	185240160	24X160
185100150	10X150	185250160	25X160
185120150	12X150	185280160	28X160
185140150	14X150	185300160	30X160
185160150	16X150	185320160	32X160
185180150	18X150	185350160	35X160
185200150	20X150	185400160	40X160
185220160	22X160		





**Σετ τρυπάνια αέρος σε πλαστική θήκη**  
Ratioline®



**Σετ τρυπάνια κοβαλτίου σε μεταλλική θήκη**  
Ratioline®



Κωδικός	Τύπος
33380 7519 19	τεμάχια (1-10mm)
33380 7525 25	τεμάχια (1-13mm)

**PTG**

Κωδικός	Τύπος
43385 7519-A18 19	τεμάχια (1-10mm)
43385 7525-A18 25	τεμάχια (1-13mm)

**PTG**

**Σετ τρυπάνια αέρος με εξαγωνο καρέ 1/4"**



Κωδικός	Τύπος
67100	Ø1-Ø10 19 τεμάχια

**VÖLKEL**

**Σετ διαμαντοτρύπανα**



Κωδικός	Τύπος
190350410	Ø4-Ø10mm 5 τεμάχια

**KEIL**

**Σετ διαμαντοτρύπανα με εξαγωνο καρέ 1/4"**  
Profi Multicut ATM 5  
4-5-6-8-10mm



Κωδικός	Τύπος
001008051	5 τεμάχια

**alpen** drill better.

**Σετ τρυπάνια αέρος**  
Sprint Master TM 10  
1-2-3-4-5-6-7-8-9-10mm



Κωδικός	Τύπος
008110921	10 τεμάχια

**alpen** drill better.

**Φρεζάκια ZYA**

Με άξονα Ø6mm



Κωδικός	Τύπος
11.3001.065	Ø6
11.3001.080	Ø8
11.3001.090	Ø10
11.3001.105	Ø12

**Karnasch**  
PROFESSIONAL TOOLS**Φρεζάκια ZYA-S**

Με άξονα Ø6mm



Κωδικός	Τύπος
11.3011.050	Ø6
11.3011.075	Ø8
11.3011.085	Ø10
11.3011.100	Ø12

**Karnasch**  
PROFESSIONAL TOOLS**Φρεζάκια WRC**

Με άξονα Ø6mm



Κωδικός	Τύπος
11.3021.055	Ø6
11.3021.075	Ø8
11.3021.085	Ø10
11.3021.100	Ø12

**Karnasch**  
PROFESSIONAL TOOLS**Φρεζάκια KUD**

Με άξονα Ø6mm



Κωδικός	Τύπος
11.3031.055	Ø6
11.3031.060	Ø8
11.3031.070	Ø10
11.3031.080	Ø12

**Karnasch**  
PROFESSIONAL TOOLS**Φρεζάκια TRE**

Με άξονα Ø6mm



Κωδικός	Τύπος
11.3041.020	Ø6
11.3041.025	Ø8
11.3041.030	Ø10
11.3041.035	Ø12

**Karnasch**  
PROFESSIONAL TOOLS**Φρεζάκια RBF**

Με άξονα Ø6mm



Κωδικός	Τύπος
11.3051.030	Ø6
11.3051.035	Ø8
11.3051.040	Ø10
11.3051.050	Ø12

**Karnasch**  
PROFESSIONAL TOOLS**Φρεζάκια SPG**

Με άξονα Ø6mm



Κωδικός	Τύπος
11.3061.035	Ø6
11.3061.040	Ø8
11.3061.045	Ø10
11.3061.055	Ø12

**Karnasch**  
PROFESSIONAL TOOLS**Φρεζάκια KEL**

Με άξονα Ø6mm



Κωδικός	Τύπος
11.3081.020	Ø6
11.3081.025	Ø8
11.3081.035	Ø10
11.3081.045	Ø12

**Karnasch**  
PROFESSIONAL TOOLS**Φρεζάκια SKM**

Με άξονα Ø6mm



Κωδικός	Τύπος
11.3091.020	Ø6
11.3091.025	Ø8
11.3091.035	Ø10
11.3091.045	Ø12

**Karnasch**  
PROFESSIONAL TOOLS**Stand με καρβίδια με άξονα Ø3**

Κωδικός	Τύπος
4831U	

**Karnasch**  
PROFESSIONAL TOOLS

### Βύσματα ξύλου βιδωτά γαλβανιζέ

BUSSOLA



Κωδικός	Τύπος
---------	-------

22200b61215	6X15mm
22200b81220	8X20mm
22200b10020	10X20mm

**FRIULSIDER**

### Βύσματα ξύλου ορειχάλκινα

TO

Κωδικός	Τύπος
---------	-------

75100005000	M5X20
75100006000	M6X23
75100008000	M8X28
75100010000	M10X32
75100012000	M12X38



**FRIULSIDER**

### Βύσματα ξύλου χτυπητά γαλβανιζέ

DCG



Κωδικός	Τύπος
---------	-------

22500b04000	M4
22500b05000	M5
22500b06000	M6
22500b08000	M8
22500b10000	M10

**FRIULSIDER**

### Στηρίγματα σωλήνα

CP

χωρίς πλαστικό βύσμα



Κωδικός	Σωλήνας
---------	---------

50416b00002	1/2"
50416b00003	3/4"
50416b00004	1"
50416b00005	1 1/4"
50416b00006	1 1/2"

**FRIULSIDER**

### Στηρίγματα σωλήνα

CFC

με πλαστικό βύσμα



Κωδικός	Τύπος	Σωλήνας
---------	-------	---------

50201b10000	6X30mm	Ø10
50201b12000	6X30mm	Ø12
50201b14000	6X30mm	Ø14
50201b16000	6X30mm	Ø16
50201b18000	6X30mm	Ø18
50201b20000	6X30mm	Ø20

**FRIULSIDER**

### Στηρίγματα σωλήνα βαρέως τύπου

CPI

με μόνωση



Κωδικός	Σωλήνας
---------	---------

50505b00003	3/4"
50505b00004	1"
50505b00005	1 1/4"
50505b00006	1 1/2"
50505b00007	2"
50502b00008	2 1/2"
50502b00009	3"

**FRIULSIDER**

### Ζυγκιά σωλήνα

CSA



Κωδικός	Σωλήνας
---------	---------

50801b00002	1/2"
50801b00003	3/4"
50801b00004	1"
50801b00006	1 1/2"
50801b00007	2"
50801b00009	2 1/2"
50801b00010	3"

**FRIULSIDER**

### Στηρίγματα σωλήνων INOX W5 (316)

Κωδικός	Σωλήνας	Πάσο
---------	---------	------

2APRI018	Ø18	M8
2APRI022	Ø22 1/2"	M8
2APRI028	Ø28 3/4"	M8
2APRI035	Ø35 1"	M8
2APRI040	Ø40	M8
2APRI048	Ø48 1 1/2"	M8
2APRI054	Ø54	M8
2APDRI060	Ø60 2"	M8&M10
2APDRI070	Ø70	M8&M10
2APDRI075	Ø75 2 1/2"	M8&M10
2APDRI084	Ø84	M8&M10
2APDRI090	Ø90 3"	M8&M10
2APDRI100	Ø100	M8&M10
2APDRI110	Ø110	M8&M10
2APDRI150	Ø150	M8&M10



**Lifial**

## Στηρίγματα σωλήνων (ζυγκιά)

Κωδικός	Σωλήνας	Πάσο
2AB12	½"	M6
2AB114	¼"	M8
2AB112	½"	M8
2AB212	2½"	M8
2AB3	3"	M8



## Στηρίγματα σωλήνων

Κωδικός	Σωλήνας	Πάσο
2ΑΕΡ050	½"	M8
2ΑΕΡ075	¾"	M8
2ΑΕΡ100	1"	M8
2ΑΕΡ125	1¼"	M8
2ΑΕΡ150	1½"	M8
2ΑΕΡ300	3"	M8



## Στηρίγματα σωλήνων ΒΤ με μόνωση

Κωδικός	Σωλήνας	Πάσο
2ΑΕΡΒ8075	¾"	M8
2ΑΕΡΒ8100	1"	M8
2ΑΕΡΒ8150	1½"	M8
2ΑΕΡΒ8200	2"	M8



## Τσέρκια 10m INOX W5 (316)

Κωδικός	Τύπος
1RFPI12	12X0,8mm
1RFPI17	17X0,8mm

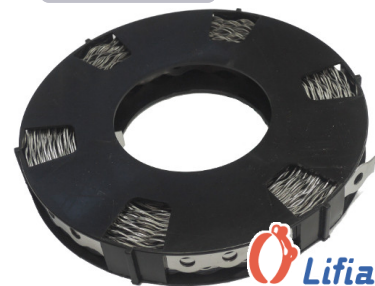

## Πλαστικά βύσματα τοίχου γενικής χρήσης

TMT



Κωδικός	Τύπος	Κωδικός	Τύπος
65000006033	6X33	65000010066	10X66
65000006046	6X46	65000012072	12X72
65000008051	8X51		

FRİULSIDER

## Πλαστικά βύσματα τοίχου γενικής χρήσης

TMT  
(με βίδα)

Κωδικός	Τύπος	Κωδικός	Τύπος
65002006033	6X33	65002010066	10X66
65002006046	6X46		
65002008051	8X51		

FRİULSIDER

## Βύσματα τοίχου νάιλον

TU



Κωδικός	Τύπος	Κωδικός	Τύπος
60100005025	5X25	60100010050	10X50
60100006030	6X30	60100012060	12X60
60100007035	7X35	60100014080	14X80
60100008040	8X40		

FRİULSIDER

## Βύσματα τοίχου

X1 Κατάλληλα και για μηχανόβιδες

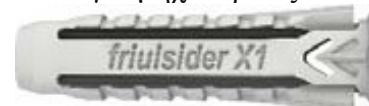

Κωδικός	Τύπος	Κωδικός	Τύπος
60070006030	6X30	60070010050	10X50
60070006050	6X50	60070012060	12X60
60070008040	8X40		

FRİULSIDER

## Βύσματα τούβλου

TDE



Κωδικός	Τύπος
63200012070	12X70
63200014075	14X75

FRİULSIDER

## Βύσματα τοίχου μακριά σκέτα

TUP1



Κωδικός	Τύπος	Κωδικός	Τύπος
60300008080	8X80	60300016160	16X160
60300010080	10X80		
60300010110	10X100		

FRİULSIDER

## Βύσματα τοίχου μακριά σκέτα

TUP4



Κωδικός	Τύπος	Κωδικός	Τύπος
6410000808000	8x80	6410001010000	10x100
6410000810000	8x100	6410001011500	10x115
6410000812000	8x120	6410001013500	10x135
6410001008500	10x85		

FRİULSIDER

## Βύσματα γυψοσανίδας νάιλον

FX



Κωδικός	Τύπος
60036006040	6X40mm
60036008050	8X50mm
60036010060	10X60mm

FRİULSIDER

**Βύσμα νάιλον χωρίς βίδα**

XP



Κωδικός	Τύπος
---------	-------

66000006045f2 6X45mm

66000008052f2 8X52mm

**FRiULSiDER****Βύσμα νάιλον με βίδα**

XP



Κωδικός	Τύπος
---------	-------

66001006045f2 6X45mm

66001008052f2 8X52mm

**FRiULSiDER****Πλαστικά βύσματα τοίχου χτυπητά**

TPP (με γαλβανιζέ βίδες)



Κωδικός	Τύπος
---------	-------

62700b05040 5X40

62700b05050 5X50

62700b06050 6X50

62700b06060 6X60

62700b08060 8X60

62700b08080 8X80

62700b08100 8X100

62700b08120 8X120

**FRiULSiDER****Βύσματα τοίχου με γαλβανιζέ βίδες**

TSS



Κωδικός	Τύπος
---------	-------

62200b06040f2 6X50

62200b06060f2 6X60

**FRiULSiDER****Βύσματα βαρέως τύπου**

TUPP



Κωδικός	Τύπος
---------	-------

64001b16160 16X160

**FRiULSiDER****Βύσμα μακρύ με βίδα καρφωτό**

TCS



Κωδικός	Τύπος
---------	-------

60301b08135 8X135mm

**FRiULSiDER****Βύσματα τοίχου με γαλβανιζέ βίδες**

TUP4 φρεζάτες βίδες με Torx T30



Κωδικός	Τύπος
---------	-------

64103b08080 8X80

64103b08100 8X100

64103b08120 8X120

64103b10085 10X85

64103b10100 10X100

64103b10115 10X115

64103b10135 10X135

**FRiULSiDER****Βύσματα τοίχου με ανοξείδωτες βίδες INOX A4**

TUP4 φρεζάτες βίδες με Torx T30



Κωδικός	Τύπος
---------	-------

64103008080 8X80

64103008100 8X100

64103008120 8X120

64103010085 10X85

64103010100 10X100

64103010115 10X115

64103010135 10X135

**FRiULSiDER****Θηλιές με βύσμα**

TAL



Κωδικός	Τύπος
---------	-------

60802b09049 9X49

**FRiULSiDER****Βύσματα με εξάγωνο άξονα**

MDE



Κωδικός	Τύπος
---------	-------

62800b00100 12X70X100X8

62800b00080 12X70X80X10

62800b00145 14X75X145X12

**FRiULSiDER**

**Γάντζοι γυψοσανίδας γαλβανιζέ**

AM

**Κωδικός** | **Τύπος**

76210b05070 M5X70mm

76210b06075 M6X75mm

**FRIULSIDER****Θηλιές γυψοσανίδας γαλβανιζέ**

AM

**Κωδικός** | **Τύπος**

76310b04070 M4X70mm

76310b05070 M5X70mm

**FRIULSIDER****Βύσματα γυψοσανίδας πλαστικά**

TAN

**Κωδικός** | **Τύπος**

65503015033 15X33mm

**FRIULSIDER****Βύσματα γυψοσανίδας μεταλλικά**

TRZ

**Κωδικός** | **Τύπος**

75006013030 13X30mm

**FRIULSIDER****Πλαστικά βύσματα YTONG**

TML

**Κωδικός** | **Τύπος**

62601006050 M6 10X50

62601008060 M8 12X60

62601010070 M10 14X70

**FRIULSIDER****Βύσματα θερμοπρόσοψης**

FOX (Βιδώνουν με Torx T40)

**Κωδικός** | **Τύπος**

61951025050 25X50

61951025085 25X85

**FRIULSIDER****Βύσματα γυψοσανίδας αρθρωτά**

TMC

**Κωδικός** | **Τύπος**

75001004038 M4X41 8X33mm

75001004045 M4X47 8X39mm

75001005045 M5X43 10X37mm

75001005058 M5X60 10X53mm

75001005071 M5X74 10X65mm

75001006045 M6X45 12X37mm

75001006058 M6X60 12X53mm

75001006071 M6X74 12X66mm

**FRIULSIDER****Πένσα αρθρωτών βυσμάτων**

TMC tool

**Κωδικός**

49901000000

**FRIULSIDER**

**Γάντζοι γαλβανιζέ**

GF



Κωδικός	Τύπος
---------	-------

77602b06050	M6X50mm
77602b08060	M8X60mm
77602b10073	M10X73mm
77602b12090	M12X90mm

**FRIULSIDER****Βίδες θηλιές γαλβανιζέ**

FM776

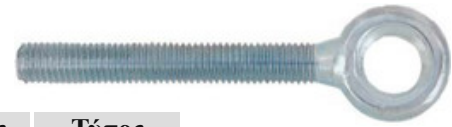

Κωδικός	Τύπος
---------	-------

77601b06050	M6X50mm
77601b08060	M8X60mm
77601b10073	M10X73mm
77601b12090	M12X90mm

**FRIULSIDER****Ξυλόβιδες γωνίες γαλβανιζέ**

NFER



Κωδικός	Τύπος
---------	-------

85000b20050	20X50
85000b20060	20X60
85000b20070	20X70
85000b21080	21X80
85000b22100	22X100
85000b22100	23X100
85000b23120	23X120

**FRIULSIDER****Ξυλόβιδες γάντζοι γαλβανιζέ**

NFEG



Κωδικός	Τύπος
---------	-------

85200b18050	18X50
85200b19060	19X60
85200b19070	19X70
85200b20080	20X80
85200b21090	21X90
85200b23100	23X100
85200b23120	23X120

**FRIULSIDER****Ξυλόβιδες θηλιές γαλβανιζέ**

NFEO



Κωδικός	Τύπος	Κωδικός	Τύπος
---------	-------	---------	-------

85300b18050	18X50	85300b22100	22X100
85300b19060	19X60	85300b22120	22X120
85300b20080	20X80	85300b23100	23X100
85300b21090	21X90	85300b23120	23X120
85300b22080	22X80	85300b23140	23X140

**FRIULSIDER****Ξυλόβιδες κρίκοι γαλβανιζέ**

TUVL-P



Κωδικός	Τύπος	Οπή
---------	-------	-----

85302b12120	12X80	23mm
85310b12120	12X80	50mm
85302b12160	12X80	23mm
85310b12160	12X80	50mm

**FRIULSIDER****Στριφονόβιδες γαλβανιζέ**

VSS / VCS



Κωδικός	Τύπος	Κωδικός	Τύπος	Κωδικός	Τύπος
---------	-------	---------	-------	---------	-------

01100b06050	6X50	01000b08070	8X70	01000b10090	10X90
01100b06060	6X60	01000b08080	8X80	01000b10100	10X100
01100b06070	6X70	01000b08090	8X90	01000b10120	10X120
01100b06080	6X80	01000b08100	8X100	01000b10140	10X140
01100b06090	6X90	01000b08120	8X120	01000b10180	10X180
01100b06100	6X100	01000b08140	8X140		
01100b06110	6X110	01000b08160	8X160		
01000b08050	8X50	01000b10070	10X70		
01000b08060	8X60	01000b10080	10X80		

**FRIULSIDER**

**Βίδες ντίζες γαλβανιζέ**BFK  
για χημικά βύσματα

Κωδικός	Τύπος
21911b10115	M10X115mm
21911b12120	M12X120mm
21911b12160	M12X160mm
21911b16190	M16X190mm

**FRIULSIDER****Πλαστικά δίχτυα χημικής αγκύρωσης**

BRP



Κωδικός	Τύπος
63300015085	15X85mm
63300015130	15X130mm

**FRIULSIDER****Φυσίγγιο χημικής αγκύρωσης NEO**

KEM955 [HR955]



Κωδικός	Τύπος
95500000000	300ml

**FRIULSIDER****Βύσματα ντίζας γαλβανιζέ χωρίς χείλος**

TAP



Κωδικός	Τύπος
75203b06000	M6 8X25
75203b08000	M8 10X30
75203b10000	M10 12X40
75203b12000	M12 15X50
75203b16000	M16 20X65

**FRIULSIDER****Βύσματα ντίζας γαλβανιζέ με χείλος**

TAP



Κωδικός	Τύπος
75205b0800000	M8 10X30
75205b1000000	M10 12X40
75205b1200000	M12 15X50

**FRIULSIDER****Βύσματα ντίζας ανοξείδωτα INOX A2**

TAP



Κωδικός	Τύπος
75204006000	8X25 M6
75204008000	10X30 M8
75204010000	12X40 M10
75204012000	15X50 M12

**FRIULSIDER****Μεταλλικά βύσματα χωρίς βίδα γαλβανιζέ**

FM744 galv



Κωδικός	Τύπος	Οπή
74400b10040	10X40mm	M6
74400b14050	14X50mm	M8
74400b16060	16X60mm	M10
74400b20080	20X80mm	M12
74400b25100	25X100mm	M16

**FRIULSIDER****Μεταλλικά βύσματα χωρίς βίδα INOX**

FM744 inox



Κωδικός	Τύπος	Οπή
74400b12050	12X50mm	M6
74400b14050	14X55mm	M8
74400b16060	16X65mm	M10
74400b20080	20X80mm	M12

**FRIULSIDER**

**Μεταλλικά βύσματα κουφωμάτων**

TMF



Κωδικός	Τύπος
77202b10092	10X92 M6
77202b10112	10X112 M6

**FRIULSIDER****Μεταλλικά βύσματα μπετού**

TSA



Κωδικός	Τύπος
79602b08060	8X60
79602b08080	8X80
79602b10080	10X80
79602b12100	12X100
79602b16150	16X150

**FRIULSIDER****Μεταλλικά βύσματα βαρέως τύπου γαλβανιζέ**

ATS

**Μεταλλικά βύσματα με πάσο γαλβανιζέ**

ATS-evo B

Βαρέως τύπου



Κωδικός	Τύπος	Οπή
79402b18200	18X200mm	M12

**FRIULSIDER**

Κωδικός	Τύπος	Οπή
79302b10080	10X80mm	M6
79302b10110	10X110mm	M6
79302b12080	12X80mm	M8
79302b12120	12X120mm	M8
79302b15100	15X100mm	M10
79302b15130	15X130mm	M10
79302b15180	15X180mm	M10
79302b18125	18X125mm	M12
79302b18150	18X150mm	M12
79302b18200	18X200mm	M12
79302b24140	24X140mm	M16
79302b24165	24X165mm	M16

**FRIULSIDER****Μεταλλικά βύσματα με πάσο γαλβανιζέ**

WA Ελαφρού τύπου FM18000b



Τύπος	Τύπος
6X55mm	12X135mm
6X65mm	12X160mm
8X75mm	12X180mm
8X90mm	16X125mm
8X115mm	16X140mm
10X90mm	16X175mm
10X120mm	20X130mm
10X140mm	20X160mm
12X110mm	20X220mm

**FRIULSIDER****Μεταλλικά βύσματα χτυπητά γαλβανιζέ**

FM753 galv



Κωδικός	Τύπος	Κωδικός	Τύπος	Κωδικός	Τύπος
75320b06065	M6X65mm	75320b10170	M10X170mm	75320b14200	M14X200mm
75320b06085	M6X85mm	75320b12080	M12X80mm	75320b16125	M16X125mm
75320b08050	M8X50mm	75320b12110	M12X110mm	75320b16145	M16X145mm
75320b08075	M8X75mm	75320b12135	M12X135mm	75320b16175	M16X175mm
75320b08090	M8X90mm	75320b12160	M12X160mm	75320b16215	M16X215mm
75320b08115	M8X115mm	75320b12185	M12X185mm	75320b20170	M20X170mm
75320b10075	M10X75mm	75320b14110	M14X110mm	75320b20215	M20X215mm
75320b10090	M10X90mm	75320b14130	M14X130mm		
75320b10120	M10X120mm	75320b14150	M14X150mm		
75320b10145	M10X145mm	75320b14170	M14X170mm		

**FRIULSIDER**



## Στριφώνια φρεζάτα γαλβανιζέ



FM-WOOD PRO



Κωδικός	Τύπος	Κωδικός	Τύπος	Κωδικός	Τύπος
07310d06080	6X80	07310d08120	8X120	07310d10100	10X100
07310d06100	6X100	07310d08140	8X140	07310d10140	10X140
07310d06120	6X120	07310d08160	8X160	07310d10160	10X160
07310d06140	6X140	07310d08180	8X180	07310d10200	10X200
07310d06160	6X160	07310d08200	8X200	07310d10240	10X240
07310d06180	6X180	07310d08240	8X240	07310d10260	10X260
07310d06200	6X200	07310d08260	8X260	07310d10280	10X280
07310d08080	8X80	07310d08300	8X300	07310d10300	10X300
07310d08100	8X100	07310d10080	10X80		

**FRIULSIDER**

## Μπετονόβιδες γαλβανιζέ



VF



Κωδικός	Τύπος
19419b07040	7,5X40
19419b07060	7,5X60
19419b07080	7,5X80
19419b07100	7,5X100
19419b07120	7,5X120
19419b07150	7,5X150
19419b07180	7,5X180

**FRIULSIDER**

## Μπετονόβιδες εξάγωνες γαλβανιζέ



VF



Κωδικός	Τύπος
19063b06060	6,6X60
19063b06070	6,6X70
19063b06085	6,6X85
19063b06105	6,6X105

**FRIULSIDER**

**Τζαμοκόφτης**



**Κωδικός**

71561 28-239000-0



**Τζαμοκόφτης επαγγελματικός**



**Κωδικός**

71710



**Τζαμοκόφτης επαγγελματικός**

Βαρέως τύπου

\*για πάχος έως 10mm



**Κωδικός**

28-250014-0  
50000



**Τζαμοκόφτης επαγγελματικός**

Βαρέως τύπου

\*για πάχος έως 20mm



**Κωδικός**

28-25000-0  
71750



**Βεντούζα τζαμιών διπλή**

\*για βάρος έως 100 κιλά



**Κωδικός**

63403A



**Μαγνητικό πιάτο στρόγγυλο Ø150**



**Κωδικός**

88001



**Μαγνητικό πιάτο ορθογώνιο 360X160**



**Κωδικός**

88003



**Χωνιά πλαστικά σετ 4 τεμ. NEO**

Κωδικός	Τύπος
02360	Ø50-75-100-120

**PRESSOL****Χωνιά πλαστικά NEO**

Κωδικός	Τύπος
02366	Ø200
02367	Ø250
02367 020	Ø250 με σίτα

**PRESSOL****Χωνιά πλαστικά NEO**

Κωδικός	Τύπος
02372	Ø160 χωρίς ρουξούνι
02674	Ø160 με ρουξούνι

**PRESSOL****Χωνιά μεταλλικά NEO**

Με σίτα



Κωδικός	Τύπος
02342	Ø160
02344	Ø200

**PRESSOL****Ρουξούνια NEO**

Κωδικός	Τύπος
02640	Μεταλλικό Ø40X300mm
00241	Πλαστικό Ø45X320mm

**PRESSOL****Πλαστικές κανάτες ογκομέτρησης NEO**PP Πολυπροπυλένιο  
Κατάλληλα για τρόφιμα

Κωδικός	Τύπος
07061	0,5ℓ
07062	1ℓ
07063	2ℓ
07071	Σετ και τα 3

**PRESSOL****Μπετόνια καυσίμων NEO**

Κωδικός	Τύπος
21131	5ℓ
21133	10ℓ
21137	20ℓ

**PRESSOL****Μπετόνια νερού NEO**

Κωδικός	Τύπος
21163	10ℓ
21167	20ℓ
21088	βρυσάκι

**PRESSOL**

**Ταινίες συσκευασίας διαφανείς**



Κωδικός	Τύπος	
	48mmX50m θορυβώδεις	36
5213200005	48mmX60m θορυβώδεις	36
5100300006	48mmX50m αθόρυβες	36
5100300004	48mmX60m αθόρυβες	36



**Ταινίες συσκευασίας καφέ**



Κωδικός	Τύπος	
5100600006	48mmX50m θορυβώδεις	36
5213400004	48mmX60m θορυβώδεις	36
	48mmX50m αθόρυβες	36
5100600004	48mmX60m αθόρυβες	36



**Ταινίες συσκευασίας PVC διαφανείς**



Κωδικός	Τύπος	
0801900038	48mmX60m	36



**Ταινίες συσκευασίας PVC καφέ**



Κωδικός	Τύπος	
0802200043	48mmX60m	36



**Χαρτοταινίες**



Κωδικός	Τύπος	
5013900013	19mmX41m	96
5013900012	24mmX41m	72
5013900011	30mmX41m	60
5013900010	36mmX41m	48
5013900009	48mmX41m	36



**Ταινίες σήμανσης άσπρο κόκκινο**



Κωδικός	Τύπος
5310000004	70mmX200m



**Αυτοκόλλητες αλουμινοταινίες**



Κωδικός	Τύπος
5300200000	48mmX10m



**Στρες φιλμ χειρός**

Μαδρέν: 200gr



Κωδικός	Τύπος	
1703700051	1,60kg 23μm Διαφανές	6
1703400005	1,60kg 23μm Μαύρο	6



**Μονωτικές ταινίες PVC**

Κωδικός	Τύπος
DJ-5403800004	17mm λευκή
DJ-5403800002	17mm μαύρη
DJ-5403800006	17mm γκρι
DJ-5403800000	17mm κόκκινη
DJ-5403800001	17mm κίτρινη
DJ-5303800002	48mm λευκή
DJ-5303800003	48mm μαύρη



**Νυστέρι με 16 λεπίδες****Κωδικός**  
D-12YE**KDS®****Φαλτσέτα με σπαστή λεπίδα 9mm****Κωδικός**  
S-11**KDS®****Φαλτσέτα με σπαστή λεπίδα 9mm 30°****Κωδικός**  
S-18**KDS®****Φαλτσέτα με σπαστή λεπίδα 18mm****Κωδικός**  
GC-401**KDS®****Φαλτσέτα με σπαστή λεπίδα 18mm****Κωδικός**  
L-18**KDS®****Φαλτσέτα με σπαστή λεπίδα 18mm  
με μαύρες λεπίδες****Κωδικός**  
G-15**KDS®****Φαλτσέτα με σπαστή λεπίδα 18mm NEO**

με ροδάκι και 3 μαύρες λεπίδες

**Κωδικός**  
L-23**KDS®****Φαλτσέτα με σπαστή λεπίδα 18mm**

με ανοικτήρι κουτιών χρωμάτων και μαύρες λεπίδες

**Κωδικός**  
L-24**KDS®****Φαλτσέτα με σπαστή λεπίδα 25mm**

με μαύρες λεπίδες

**Κωδικός**  
H-13**KDS®****Φαλτσέτα με σπαστή λάμα 18mm**

Σώμα αλουμινίου

**Κωδικός**  
L-33**KDS®****Φαλτσέτα παπαγαλάκι**

Με σπαστά ανταλλακτικά

**Κωδικός**  
HK-11**KDS®****Φαλτσέτα με 2 τραπεζοειδείς λεπίδες**

Με αυτόματο κλείσιμο

**Κωδικός**  
SA-14**KDS®****Φαλτσέτα σουγιάς**

Με τραπεζοειδή λεπίδα

**Κωδικός**  
DBKWH-EU**BESSEY****Αντιολισθητικές επιφάνειες κοπής NEO**Διπλής όψης. 3 στρώσεων.  
Για πάγκους εργασίας

Κωδικός	Τύπος
SSO-1000F	300x220x3mm
SMO-2000F	450x300x3mm
MMO-3900F	620x450x3mm

**KDS®**

**Ανταλλακτικές λεπίδες 9mm**

Σετ 10 τεμαχίων

**Κωδικός**

SB-10 EVO

**KDS.****Ανταλλακτικές λεπίδες 9mm 30°**

Σετ 10 τεμαχίων

**Κωδικός**

VB-10 EVO

**KDS.****Ανταλλακτικές λεπίδες 18mm**

Σετ 10 τεμαχίων Πάχος: 0,5mm

**Κωδικός**

LB-10 EVO

**KDS.****Ανταλλακτικές λεπίδες 18mm μαύρες**

Σετ 10 τεμαχίων Πάχος: 0,6mm

**Κωδικός**

GB-10B EVO

**KDS.****Ανταλλακτικές λεπίδες ξύστρας 18mm μαύρες**Χωρίς εγκοπές  
Σετ 10 τεμαχίων**Κωδικός**

LB-10BNL EVO

**KDS.****Ανταλλακτικές λεπίδες 25mm μαύρες**

Σετ 10 τεμαχίων

**Κωδικός**

HB-10B EVO

**KDS.****Ανταλλακτικές λάμμες παπαγαλάκια**

Σετ 5 τεμαχίων

**Κωδικός**

HK-5 EVO

**KDS.****Ανταλλακτικές λεπίδες για D-12**

10 τεμάχια

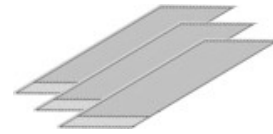
**Κωδικός**

DB-48

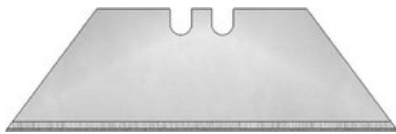
**KDS.****Ανταλλακτικές λεπίδες τραπεζοειδείς****Κωδικός**

195000

**Ανταλλακτικές λεπίδες τραπεζοειδείς μαύρες**

Σετ 5 τεμαχίων

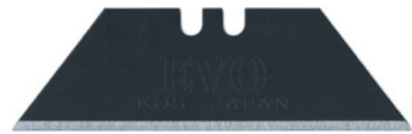
**Κωδικός**

TB-5B

**KDS.**



**Λεπίδες σέγας σετ**

HC12  
HG13  
HGS14  
MG11  
MG12



Κωδικός  
ASSOR2000



**Λεπίδες σέγας ξύλο-πλαστικό 75mm**

5 τεμάχια  
**10 τρι**



Κωδικός  
HC12



**Λεπίδες σέγας ξύλο ταχείας κοπής 50mm**

5 τεμάχια  
**19 τρι**



Κωδικός  
HC12K



**Λεπίδες σέγας ξύλο-πλαστικό 75mm**

ανάποδα δόντια 5 τεμάχια  
**10 τρι**

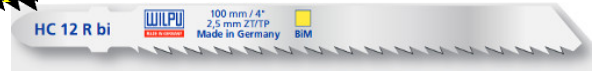

Κωδικός  
HC12Rbi



**Λεπίδες σέγας ξύλο-πλαστικό 75mm**

5 τεμάχια  
**8,5 τρι**



Κωδικός  
HC13bi



**Λεπίδες σέγας ξύλο-πλαστικό 75mm**

5 τεμάχια  
**6,35**



Κωδικός  
HC14



**Λεπίδες σέγας ξύλου 105mm**

5 τεμάχια  
**10 τρι**



Κωδικός  
HC32



**Λεπίδες σέγας ξύλο-πλαστικό 105mm**

5 τεμάχια  
**6,35**



Κωδικός  
HC34



**Λεπίδες σέγας ξύλο-πλαστικό 75mm**

5 τεμάχια  
**8,5 τρι**



Κωδικός  
HG13



**Λεπίδες σέγας ξύλο-πλαστικό 75mm**

5 τεμάχια  
**8,5 τρι**



Κωδικός  
HG13G



**Λεπίδες σέγας ξύλου ταχείας κοπής 75mm**

5 τεμάχια  
**6,35**



Κωδικός  
HGS14



**Λεπίδες σέγας ξύλου ταχείας κοπής 155mm**

5 τεμάχια  
**6,35**



Κωδικός  
HGS54



## Λεπίδες σέγας για laminate 60mm

ανάποδα δόντια 5 τεμάχια

13 τρι

Κωδικός  
HC19Rbi

## Λεπίδες σέγας για λάστιχο-πλαστικό 75mm

5 τεμάχια

Κωδικός  
HWL100

## Λεπίδες σέγας για λάστιχο-δέρμα-χαρτί 75mm

5 τεμάχια

Κωδικός  
HWL54

## Λεπίδες σέγας για μέταλλα 75mm

5 τεμάχια

8,5 τρι

Κωδικός  
K14

## Λεπίδες σέγας για μέταλλα 55mm

5 τεμάχια

21 τρι

Κωδικός  
MG11

## Λεπίδες σέγας για inox 55mm

5 τεμάχια

21 τρι

Κωδικός  
MG11bi

## Λεπίδες σέγας για inox 55mm

5 τεμάχια

13 τρι

Κωδικός  
MG12

## Λεπίδες σέγας για inox 105mm

5 τεμάχια

25 τρι

Κωδικός  
MG31bi

## Λεπίδες σέγας για panel 155mm

5 τεμάχια

25 τρι

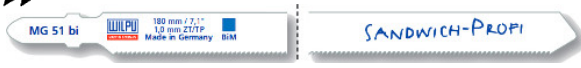
Κωδικός  
MG51bi

## Λεπίδες σέγας πλαστικά-μέταλλα 75mm

5 τεμάχια

Κωδικός  
ST006/bi

## Λεπίδες σέγας για ξύλο-πλαστικό 91mm

PVC - Plexiglass - Πάγκους κουζίνας

5 τεμάχια

10 τρι

Κωδικός  
HC123Star

## Λεπίδες σέγας για ξύλο-πλαστικό 91mm

Για κούρμπες σε πάγκους κουζίνας

5 τεμάχια

10 τρι

Κωδικός  
HC22DV



**Διαμαντολεπίδα σέγας για γυαλί-κεραμικά  
100mm**

1 τεμάχιο



Κωδικός  
DT1



**Λεπίδες σέγας μέταλλα 75mm**

5 τεμάχια

**21 τρι**



Κωδικός  
MMG1



**Λεπίδες σέγας ξύλο-πλαστικό 75mm**

5 τεμάχια

**10 τρι**



Κωδικός  
UHC12



**Λεπίδες σέγας ξύλο-πλαστικό 105mm**

5 τεμάχια

**6,35**



Κωδικός  
UHC32



**Λεπίδες σέγας ξύλο-πλαστικό 75mm**

5 τεμάχια

**8,5 τρι**



Κωδικός  
UHG13



**Λεπίδες σέγας για ξύλο 105mm**

5 τεμάχια

**10 τρι**



Κωδικός  
UHGS34



**Λεπίδες σέγας για μέταλλο 75mm**

5 τεμάχια

**8,5 τρι**



Κωδικός  
UK14bi



**Λεπίδες σέγας για μέταλλο 55mm**

5 τεμάχια

**21 τρι**



Κωδικός  
UMG11



**Λεπίδες σέγας για μέταλλο 55mm**

5 τεμάχια

**21 τρι**



Κωδικός  
UMG11bi



## Λεπίδες σπαθοσέγας ξύλο-μέταλλο

5 τεμάχια



Κωδικός Μήκος

1014C/150 130mm

1014C/225 205mm

1014C/280 260mm



## Λεπίδες σπαθοσέγας ξύλο-μέταλλο

5 τεμάχια



Κωδικός Μήκος

1014CD/150 130mm

1014CD/225 205mm



## Λεπίδες σπαθοσέγας για inox

5 τεμάχια



Κωδικός Μήκος

3018/150 130mm

3018/200 180mm

3018/280 260mm



## Λεπίδες σπαθοσέγας για inox

5 τεμάχια



Κωδικός Μήκος

3013/250 250mm



## Λεπίδες σπαθοσέγας για ξύλο-πλαστικό

5 τεμάχια



Κωδικός Μήκος

3019/150 130mm

3019/225 205mm



## Λεπίδες σπαθοσέγας για ξύλο-πλαστικό

5 τεμάχια



Κωδικός Μήκος

3021/150 130mm

3021/225 205mm

3021/300 280mm



## Λεπίδες σπαθοσέγας για ξύλο-πλαστικό

5 τεμάχια



Κωδικός Μήκος

3021/150bi 130mm

3021/225bi 205mm

3021/300bi 280mm



## Λεπίδες σπαθοσέγας για ξύλο-πλαστικό

5 τεμάχια



Κωδικός Μήκος

3025/150 150mm

3025/300 300mm



## Λεπίδες σπαθοσέγας για ξύλο-μέταλλο

3 τεμάχια



Κωδικός Μήκος

3028/230 195mm



## Λεπίδες σπαθοσέγας για ξύλο

5 τεμάχια



Κωδικός Μήκος

3029/240 220mm



**Λεπίδες σπαθοσέγας Hypercut**

3 τεμάχια

**10 τρι****Κωδικός Μήκος**

3050/150 130mm

3050/225 225mm

3050/300 280mm

**Λεπίδες σπαθοσέγας Hypercut**

3 τεμάχια

**8/10****Κωδικός Μήκος**

3060/125 125mm

3060/225 225mm

3060/300 280mm

**Λεπίδες σπαθοσέγας για inox**

5 τεμάχια

**14 τρι****Κωδικός Μήκος**

3014/150 150mm

3014/200 200mm

3014/280 280mm

**Λεπίδες σπαθοσέγας για inox**

5 τεμάχια

**18 τρι****Κωδικός Μήκος**

3015/200 200mm

**Λεπίδες σπαθοσέγας για inox**

5 τεμάχια

**10 τρι****Κωδικός Μήκος**

3018/150 150mm

3018/200 200mm

3018/280 280mm

**Λεπίδες σπαθοσέγας Dominator**

5 τεμάχια

**10/14****Κωδικός Μήκος**

3056/225 225mm

3056/300 300mm

**Λεπίδες σπαθοσέγας για νωπά ξύλα**

5 τεμάχια

**Κωδικός Μήκος**

3039/300 300mm

**Διαμαντολεπίδα σπαθοσέγας για γυαλί - κεραμικά**

1 τεμάχιο

**Κωδικός Μήκος**

DT200 100mm

**Λεπίδες σπαθοσέγας για κατεψυγμένα κρέατα****INOX**

1 τεμάχιο

**Κωδικός Μήκος**

INOX 300 300mm

INOX 400 400mm

**Λεπίδα σπαθοσέγας για Y-tong και τούβλα****NEO**

1 τεμάχιο

Χάλυβας με επικάλυψη καρβιδίου βολφραμίου

Για σπαθοσέγες 1000W και άνω

**Κωδικός Μήκος**

3048/445HM 455mm



## Ψαλίδια εργασίας

D840



Κωδικός	Μήκος
BCSCHPN150	150mm
BCSCHPN180	180mm
BCSCHPN250	250mm



## Ψαλίδια ραπτικής

D860



Κωδικός	Μήκος
BCSCN200	200mm
BCSCN225	225mm
BCSCN250	250mm



## Ψαλίδι γενικής χρήσης

ERDI D53



Κωδικός	Μήκος
BCSCN180	125mm



## Ψαλίδι γενικής χρήσης



Κωδικός	Μήκος
KSC-1	140mm



## Ψαλίδι καλωδίων



Κωδικός	Μήκος
9505155SB	155mm



## Πολυχρηστικό ψαλίδι



Κωδικός	Μήκος
9505190	190mm



## Κλαδευτήρι χυτό



Κωδικός	Τύπος
8020-000	210mm





**Ψαλίδι πελεκάνος**



**Κωδικός Μήκος**  
BCSP 300mm



**Ψαλίδι πελεκάνος**



**Κωδικός Μήκος**  
D22A 280mm



**Ψαλίδι ίσιο**



**Κωδικός Μήκος**  
D16S 240mm



**Ψαλίδι λαμαρίνας αριστερό**



**Κωδικός Μήκος**  
D16L 240mm



**Ψαλίδι λαμαρίνας δεξί**



**Κωδικός Μήκος**  
D16R 240mm



**Ψαλίδι nibbler**



**Κωδικός Μήκος**  
D24 265mm



**Ψαλίδι ένωσης μπουριών**



**Κωδικός Μήκος**  
D36



**Σιδηροπρίονο χειρός μίνι**



**Κωδικός** Μήκος λάμας  
242 150mm



**Σιδηροπρίονο χειρός**



**Κωδικός** Μήκος λάμας  
240 300mm



**Λάμες σιδηροπριονιού**

12 τεμάχια (PUK)



**Κωδικός** Μήκος λάμας  
238A 150mm



**Πριόνι χειροτεχνίας**

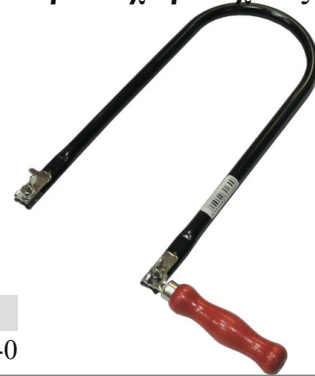

**Κωδικός**  
53010 6-178030-0



**Ανταλλακτικά πριονιού χειροτεχνίας Νο0**

Δωδεκάδες

**Κωδικός** Τύπος  
26-190000-0 Pinguin Gold  
26-187500-0 Crafta  
26-188003-0 Herkules

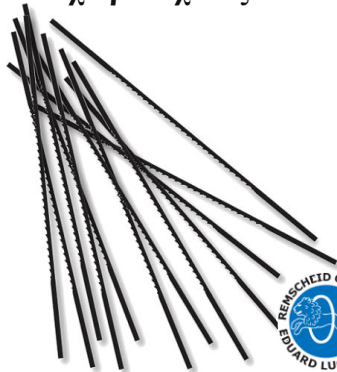

**Πριόνι ξύλου - PVC ακριβείας**



**Κωδικός** Μήκος λάμας  
PW-235 235mm



**Ανταλλακτική λάμα για το PW-235**



**Κωδικός** Μήκος λάμας  
PWB-235 235mm



**Πριόνι ξύλου γρήγορης κοπής**



**Κωδικός** Τύπος  
8007-265 265mm  
8007-B26 Ανταλλακτική λεπίδα



**Πριόνι PVC**



**Κωδικός** Τύπος  
8006-240 240mm  
8006-B24 Ανταλλακτική λεπίδα



## Πριονοκορδέλες M42

Κωδικός	Πλάτος	Πάχος	Δόντια
50M42136481?	12,7mm	0,64mm	10/14
50M421390101	12,7mm	0,90mm	10/14
50M42199010?	19mm	0,90mm	10/14
50M42199061?	19mm	0,90mm	6/10
50M421990812	19mm	0,90mm	8/12
50M42279010?	27mm	0,90mm	10/14
50M42279010?	27mm	0,90mm	4/6
50M42279058	27mm	0,90mm	5/8
50M42279061?	27mm	0,90mm	6/10
50M422790812	27mm	0,90mm	8/12
50M42341146	34mm	1,10mm	4/6
50M42341158	34mm	1,10mm	5/8
50MAT1364101	12,7mm	0,64mm	10/14
50MAT136412?	12,7mm	0,64mm	12/16
50MAT136414?	12,7mm	0,64mm	14/18

**M42**



### Δίσκοι σμυριδόπανου 115mm

Τρύπα: 22mm

Κωδικός	Grit
115ZK40	40
115ZK60	60
115ZK80	80
115ZK120	120



### Δίσκοι σμυριδόπανου 125mm

Τρύπα: 22mm

Κωδικός	Grit
125ZK40	40
125ZK60	60
125ZK80	80
125ZK120	120



### Δίσκοι λείανσης

Τρύπα: 22mm

Κωδικός	Τύπος
80271156M	115X6mm
80271256M	125X6mm
80271806M	180X6mm
80272306M	230X6mm



### Δίσκοι λείανσης inox

PREMIUMFLEX A24/30S-BF  
INOX T27



Κωδικός	Διάμετρος	Πάχος
GI1156022	115mm	6mm
GI1256422	125mm	6,4mm

### Δίσκοι λείανσης μετάλλων

PREMIUMFLEX A24/30S-BF  
T27



Κωδικός	Διάμετρος	Πάχος
GM1156022	115mm	6mm
GM1256022	125mm	6mm
GM1806522	180mm	6,5mm
GM2306522	230mm	6,5mm

### Δίσκοι κοπής μαρμάρου πάχους 1,6mm

PREMIUMFLEX C46R-BF  
BEST LIFE

Κωδικός	Τύπος
CS1151622	115X1,6mm
CS1251622	125X1,6mm



### Δίσκοι κοπής ξύλου με 14 δόντια

Αν πρόκειται να κόψετε μέταλλο, θα πρέπει να χρησιμοποιήσετε χαμηλές στροφές. Κόβει ακόμα και τα σκληρότερα ξύλα, "σάντουιτς" υλικών ακόμα και αν περιέχουν και μέταλλο.

Κωδικός	Διάμετρος
10.8050230	230mm



**Δίσκοι κοπής μετάλλων**

Τρύπα: 22mm

Κωδικός	Τύπος
80411151	115X1mm
804111525M	115X2,5mm
80411251	125X1mm
804112525M	125X2,5mm
804118025M	180X2,5mm
804123019	230X1,9mm
804123025M	230X2,5mm



**Δίσκοι κοπής inox special**

Τρύπα: 22mm

Κωδικός	Τύπος
P804111519S	115X1mm
P804112519S	125X1mm
P804123019S	230X1,9mm



**Δίσκοι κοπής all in one**

Κατάλληλοι για ασφάλι, ανοξείδωτα, PVC, αλουμίνιο, μπετόν  
Τρύπα: 22mm

Κωδικός	Τύπος
SPC80411151	115X1mm
SPC80411251	125X1mm

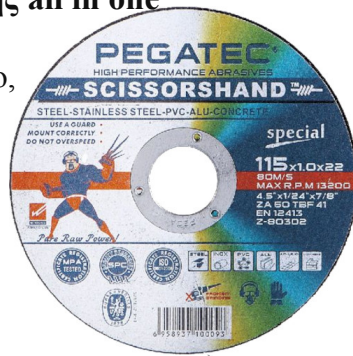

**Δίσκοι κοπής πέτρας**

Τρύπα: 22mm

Κωδικός	Τύπος
804111516S	115X1,6mm
804112516S	125X1,6mm
80412303S	230X3,0mm



**Δίσκοι κοπής μετάλλων ίσιοι για inox**

PROMAX A60X-BF INOX T41  
Πάχος 1mm

Κωδικός	Διάμετρος
CM1151022	115mm
CM1251022	125mm



**Δίσκοι κοπής μετάλλων ίσιοι**

PROMAX A36U-BF T41  
BEST SPEED  
Πάχος 2mm

Κωδικός	Διάμετρος
CMP1152022	115mm
CMP1252022	125mm
CMP1802022	180mm
CMP2302022	230mm



**Δίσκοι κοπής inox ίσιοι**

PREMIUMFLEX A24-30S-BF  
INOX T27  
Πάχος 2mm

Κωδικός	Διάμετρος
CP1802022	180mm
CP2302022	230mm



**Σμυριδοτροχοί γενικής χρήσης**

ALU-OXIDE CERAMIC WHEEL

Για μέταλλα  
Τρύπα: 32mm

Κωδικός	Τύπος	Grit
A1252032A36	125X20mm	A36
A1252032A46	125X20mm	A46
A1502032A36	150X20mm	A36
A1502032A46	150X20mm	A46
A2002032A36	200X20mm	A36
A2002032A46	200X20mm	A46
A2002532A36	200X25mm	A36
A2002532A46	200X25mm	A46



**Σμυριδοτροχοί για βίντια**

GREEN SIC CERAMIC WHEEL

Τρύπα: 32mm

Κωδικός	Τύπος	Grit
CAR1252032	125X20mm	80
CAR1502032	150X20mm	80
CAR2002032	200X20mm	80
CAR2002532	200X25mm	80



**Διαμαντόδισκος**

Κόβει: μπετόν

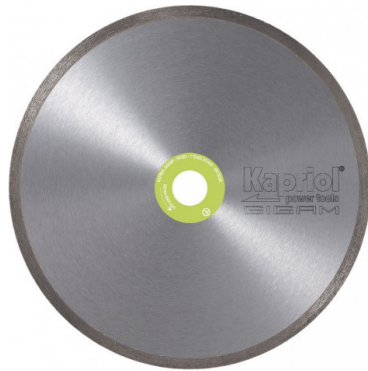

Κωδικός	Διάμετρος	Πάχος
54318	115mm	
54317	125mm	
54319	230mm	



**Διαμαντόδισκος**

Κόβει: μπετόν, τούβλο, πέτρα

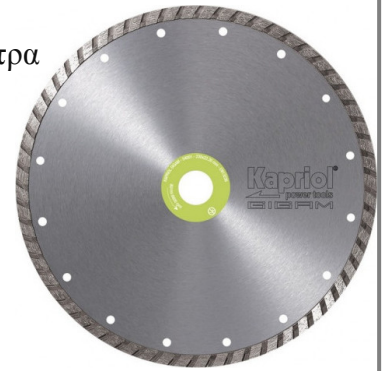

Κωδικός	Διάμετρος	Πάχος
54115	115mm	
54107	125mm	
54116	230mm	



**Διαμαντόδισκος**

Κόβει: μπετόν, τούβλο, πέτρα

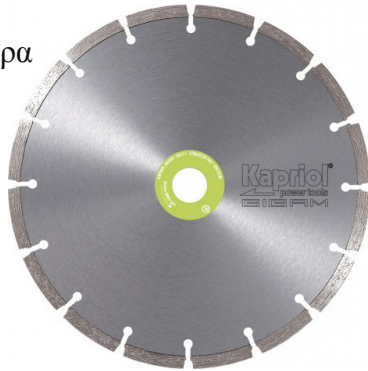

Κωδικός	Διάμετρος	Πάχος
54108	115mm	
54104	125mm	
54109	230mm	



**Διαμαντόδισκος κοπής πλακιδίων**

DS 100 T

Υγρής & ξηράς κοπής.

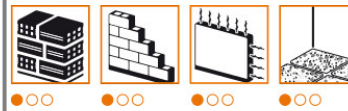

Κωδικός	Διάμετρος	Πάχος
54001	230mm	3mm



**Δίσκος κοπής για ξύλο - γυψοσανίδες - PVC**

Expert  
Ξηράς κοπής

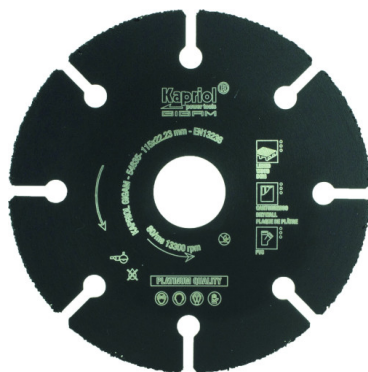

Κωδικός	Διάμετρος	Πάχος
54835	115mm	
54837	230mm	



**Διαμαντόδισκος κοπής δομικών υλικών**

JC 190

Υγρής & ξηράς κοπής

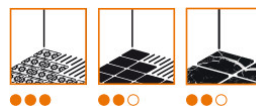

Κωδικός	Διάμετρος	Πάχος
54366	230mm	1,6mm



## Δίσκοι κοπής HSS

Κωδικός	Τύπος	Δόντια
D2001832200	200X1,80X32	200
D2251932180	225X1,80X32	180
D2251932220	225X1,90X32	220
D2252032180	225X2,00X32	180
D2252032220	225X2,00X32	220
D2502032160	250X2,00X32	160
D2502032200	250X2,00X32	200
D2752532220	275X2,500X32	220
D3002532220	300X2,500X32	220
D3152532220	315X2,500X32	220

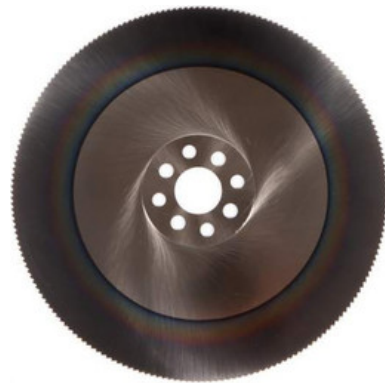

## Δίσκοι κοπής HSS κοβαλτίου

Κωδικός	Τύπος	Δόντια
DC2250232180	225X2,00X32	180
DC2250232220	225X2,00X32	220
DC2502032200	250X2,00X32	200
DC2502032160	250X2,00X32	160
DC2752532220	275X2,500X32	220
DC3002532220	300X2,500X32	220
DC3152532220	315X2,500X32	220

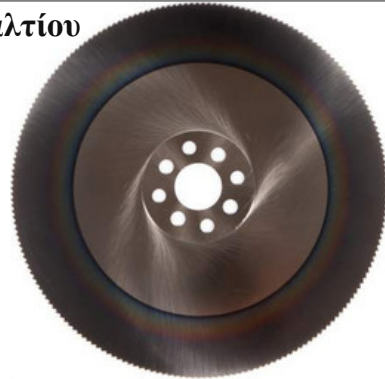

## Κοπτικά τρύπας μετάλλων ET

ART.20.1020

Κωδικός	Τύπος	Κωδικός	Τύπος	Κωδικός	Τύπος	Κωδικός	Τύπος
20.1020.014	Ø14	20.1020.028	Ø28	20.1020.042	Ø42	20.1020.060	Ø60
20.1020.016	Ø16	20.1020.030	Ø30	20.1020.045	Ø45	20.1020.063	Ø63
20.1020.018	Ø18	20.1020.032	Ø32	20.1020.048	Ø48	20.1020.065	Ø65
20.1020.020	Ø20	20.1020.034	Ø34	20.1020.050	Ø50	20.1020.068	Ø68
20.1020.022	Ø22	20.1020.035	Ø35	20.1020.052	Ø52		
20.1020.024	Ø24	20.1020.038	Ø38	20.1020.054	Ø54		
20.1020.025	Ø25	20.1020.040	Ø40	20.1020.058	Ø58		



## Ποτηροκορώνες με βίντια

ART.20.1315 για μαγνητικά δράπανα

Κωδικός	Τύπος	Κωδικός	Τύπος	Κωδικός	Τύπος
20.1315.014	Ø14	20.1315.024	Ø24	20.1315.038	Ø38
20.1315.015	Ø15	20.1315.025	Ø25	20.1315.040	Ø40
20.1315.016	Ø16	20.1315.028	Ø28	20.1315.042	Ø42
20.1315.017	Ø17	20.1315.030	Ø30	20.1315.045	Ø45
20.1315.018	Ø18	20.1315.032	Ø32	20.1315.048	Ø48
20.1315.020	Ø20	20.1315.034	Ø34	20.1315.050	Ø50
20.1315.022	Ø22	20.1315.035	Ø35		



**Κοπτικά τρύπας μετάλλων με βίντια**

Κωδικός	Τύπος	Κωδικός	Τύπος	Κωδικός	Τύπος
20.1130.014	Ø14	20.1130.030	Ø30	20.1130.063	Ø63
20.1130.015	Ø15	20.1130.032	Ø32	20.1130.065	Ø65
20.1130.016	Ø16	20.1130.034	Ø34	20.1130.068	Ø68
20.1130.017	Ø17	20.1130.036	Ø36	20.1130.070	Ø70
20.1130.018	Ø18	20.1130.038	Ø38	20.1130.073	Ø73
20.1130.019	Ø19	20.1130.040	Ø40	20.1130.075	Ø75
20.1130.020	Ø20	20.1130.042	Ø42	20.1130.080	Ø80
20.1130.021	Ø21	20.1130.045	Ø45	20.1130.085	Ø85
20.1130.022	Ø22	20.1130.046	Ø46	20.1130.090	Ø90
20.1130.023	Ø23	20.1130.048	Ø48	20.1130.095	Ø95
20.1130.024	Ø24	20.1130.050	Ø50	20.1130.100	Ø100
20.1130.025	Ø25	20.1130.052	Ø52	20.1130.110	Ø110
20.1130.026	Ø26	20.1130.055	Ø55	20.1130.120	Ø120
20.1130.027	Ø27	20.1130.058	Ø58		
20.1130.028	Ø28	20.1130.060	Ø60		

**Karnasch**  
PROFESSIONAL TOOLS**Ποτηροτρύπανα**

Κωδικός	Τύπος	Κωδικός	Τύπος	Κωδικός	Τύπος
20.1500.014	Ø14	20.1500.041	Ø41	20.1500.076	Ø76
20.1500.016	Ø16	20.1500.043	Ø43	20.1500.079	Ø79
20.1500.017	Ø17	20.1500.044	Ø44	20.1500.083	Ø83
20.1500.019	Ø19	20.1500.046	Ø46	20.1500.089	Ø89
20.1500.020	Ø20	20.1500.048	Ø48	20.1500.092	Ø92
20.1500.021	Ø21	20.1500.050	Ø50	20.1500.095	Ø95
20.1500.022	Ø22	20.1500.051	Ø51	20.1500.098	Ø98
20.1500.024	Ø24	20.1500.052	Ø52	20.1500.102	Ø102
20.1500.025	Ø25	20.1500.054	Ø54	20.1500.105	Ø105
20.1500.027	Ø27	20.1500.057	Ø57	20.1500.108	Ø108
20.1500.028	Ø28	20.1500.059	Ø59	20.1500.114	Ø114
20.1500.029	Ø29	20.1500.060	Ø60	20.1500.121	Ø121
20.1500.030	Ø30	20.1500.064	Ø64	20.1500.127	Ø127
20.1500.032	Ø32	20.1500.065	Ø65	20.1500.140	Ø140
20.1500.033	Ø33	20.1500.067	Ø67	20.1500.152	Ø152
20.1500.035	Ø35	20.1500.068	Ø68	20.1500.160	Ø160
20.1500.038	Ø38	20.1500.070	Ø70		
20.1500.040	Ø40	20.1500.073	Ø73		

**Karnasch**  
PROFESSIONAL TOOLS

### Σετ ποτηροτρώπανα ξύλου

Νέου τύπου με 6 λεπίδες  
32/38/45/51/57/63mm

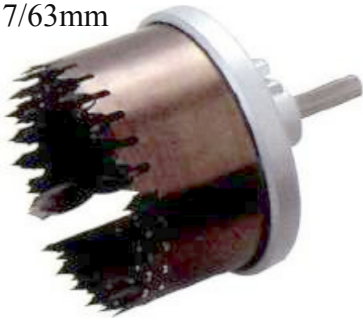

Κωδικός	Τύπος	Βάθος
2073-006	32-63mm	50mm

**TopMan**

### Σετ ποτηροτρώπανα ξύλου

Με 7 λεπίδες  
25/32/38/45/51/57/63mm

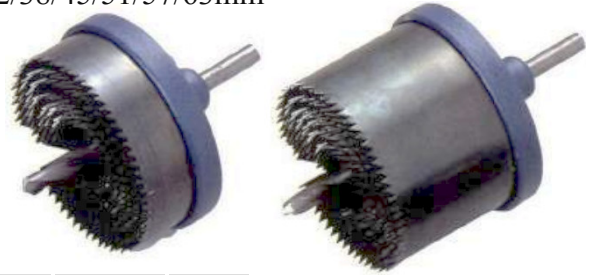

Κωδικός	Τύπος	Βάθος
2072-020	25-63mm	20mm
2072-045	25-63mm	45mm

**TopMan**

### Σετ ποτηροτρώπανα ξύλου B/T

Βάθος κοπής: 40mm



Κωδικός	Τύπος
2077-040	46-53-59-66-73-82-94mm
2077-121	68-74-83-92-102-114-121mm

**TopMan**

### Κώνικες φρέζες κοβαλτίου



Κωδικός	Τύπος
20.1447	Ø4-12
20.1448	Ø4-20
20.1449	Ø6-32
20.1450	Ø6-36
20.1470U	Ø6-38

**Karnasch**  
PROFESSIONAL TOOLS

### Κεντραδόροι ποτηροτρώπανου

μαγνητικών δρασίων



Κωδικός	Τύπος
20.1249	Ø6,34X90
20.1273	Ø7,98X105
20.1403	Ø7,98X145
20.1151	Ø7,98X157

**Karnasch**  
PROFESSIONAL TOOLS

### Αντάπτορας ποτηροτρώπανων

N2 3/8"



Κωδικός	Τύπος
20.1503	32-152

**Karnasch**  
PROFESSIONAL TOOLS

### Αντάπτορας ποτηροτρώπανων

SDS plus



Κωδικός	Τύπος
20.1511	32-152

**Karnasch**  
PROFESSIONAL TOOLS

### Αντάπτορας ποτηροτρώπανων

N1



Κωδικός	Τύπος
20.1507	14-30

**Karnasch**  
PROFESSIONAL TOOLS

### Κεντραδόρος κοπτικών



Κωδικός	Τύπος
20.1133	8X80mm

**Karnasch**  
PROFESSIONAL TOOLS

### Κεντραδόρος κοπτικών

Βαρύς τύπου



Κωδικός	Τύπος
20.1445	6X80mm

**Karnasch**  
PROFESSIONAL TOOLS

### Κεντραδόρος κοπτικών



Κωδικός	Τύπος
20.1505	6X80

**Karnasch**  
PROFESSIONAL TOOLS

### Κεντραδόρος κοπτικών

Για το 20.1020



Κωδικός	Τύπος
20.1114	6X47

**Karnasch**  
PROFESSIONAL TOOLS

**Βελόνι SDS plus**

Κωδικός Μήκος  
50200250 250mm

**Κοπίδι SDS plus**

Κωδικός Τύπος  
50220250 20X250mm

**Κοπίδι φαρδύ SDS plus**

Κωδικός Μήκος  
50240250 40X250mm

**Καλέμι λούκι SDS plus**

Κωδικός Μήκος  
276P250/22 22X250mm

**Καλέμι πεταλούδα SDS plus**

Κωδικός Μήκος  
277P250/22 22X250mm

**Κοπίδι κυρτό SDS plus**

Κωδικός Τύπος  
279P200/40 40X200mm

**Βελόνι SDS plus**

Κωδικός Μήκος  
21225001 250mm

**Κοπίδι SDS plus**

Κωδικός Μήκος  
21225000 250mm

**Κοπίδι φαρδύ SDS top**

Κωδικός Μήκος  
275240250 250mm

**Κοπίδι κυρτό SDS MAX**

Κωδικός Μήκος  
279M300/50 50X300mm

**Καλέμι λούκι SDS MAX**

Κωδικός Μήκος  
276M300/26 26X300mm

**Καλέμι πεταλούδα SDS MAX**

Κωδικός Μήκος  
277M380/35 35X380mm

**Βελόνια SDS MAX**

Κωδικός Μήκος  
273M280 280mm  
273M400 400mm  
273M600 600mm

**Κοπίδια SDS MAX**

Κωδικός Μήκος  
273M280/25 280mm  
273M400/25 400mm  
273M600/25 600mm

**Κοπίδια φαρδιά SDS MAX**

Κωδικός Τύπος  
275M300/80 80X300mm  
275M400/50 50X400mm



**Μαχαίρια προσώπου K/10, P30, R, L**

DIN 4980 ISO 6

**Τετράγωνα****Τύπος**

10X10X90  
12X12X100  
16X16X110  
20X20X125  
25X25X140  
32X32X170

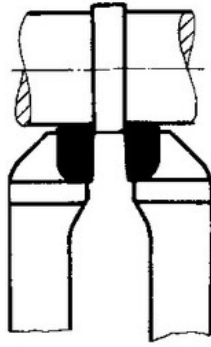
**Werner Wilke**  
Zerspanungstechnik
**Τρύπας ξεχονδρίσματος R3 P30 K/10**

DIN 4974 ISO 9

**Τύπος**

8X8X125  
10X10X150  
12X12X180  
16X16X210  
20X20X250  
25X25X300

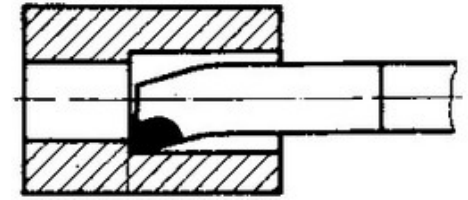
**Werner Wilke**  
Zerspanungstechnik
**Σχισίματος R, L, K/10, P30**

DIN 4981 ISO 7

**Τύπος**

12X8X10X3  
16X10X110X4  
20X12X125X5  
25X16X140X6  
32X20X170X8

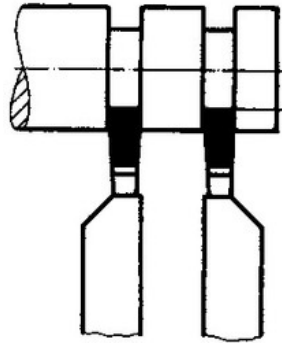
**Werner Wilke**  
Zerspanungstechnik
**Εσωτερικού σπειρώματος R, R30**

WN 283 ISO 13

**Τύπος**

10X10  
12X12  
16X16  
20X20  
25X25

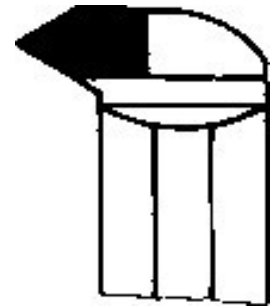
**Werner Wilke**  
Zerspanungstechnik
**Εσωτερικού σχισίματος R, P30**

WN 263 ISO 11

**Τύπος**

10X10  
12X12  
16X16  
20X20  
25X25

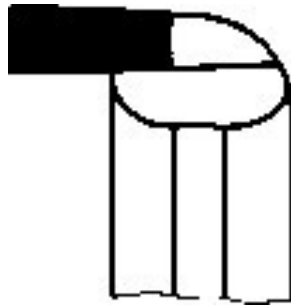
**Werner Wilke**  
Zerspanungstechnik
**Εξωτερικού σπειρώματος R, R30**

WN 282 ISO 12

**Τύπος**

12X8  
16X10  
20X12  
25X16  
32X20

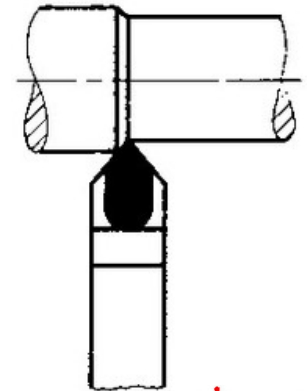
**Werner Wilke**  
Zerspanungstechnik
**Σχισίματος 12,5% Κοβάλτιο****Τύπος**

3/4"X3X150  
3/4"X4X150  
1"X4X150  
7/8"X3X150  
7/8"X4X150  
1"X5X150  
5/8"X3X150  
1/2"X3X150

**Werner Wilke**  
Zerspanungstechnik
**Τετράγωνα 12,5% Κοβάλτιο****Τύπος**

6X6X100  
8X8X100  
10X10X100  
12X12X100

**Werner Wilke**  
Zerspanungstechnik

**Κονδύλια κοβαλτίου δίπτερα**

Art.4420

**Κωδικός Τύπος**

44255	3mm
44261	4mm
44267	5mm
44273	6mm
44279	7mm
44285	8mm
44297	10mm
44306	12mm
44312	14mm
44318	16mm
44324	18mm
44330	20mm

**Κονδύλια κοβαλτίου δίπτερα μακριά**

Art.4426

**Κωδικός Τύπος**

44366	4mm
44369	5mm
44372	6mm
44378	8mm
44384	10mm
44390	12mm

**Κονδύλια τετράπτερα κοντά**

Art.4400

**Κωδικός Τύπος**

43784	3mm
43790	4mm
43796	5mm
43802	6mm
43808	7mm
43814	8mm
43826	10mm
43832	12mm
43838	14mm
43844	16mm
43850	18mm
43856	20mm
43859	22mm
43862	24mm
43865	25mm

**Κονδύλια πολύπτερα μακριά**

Art.4606

**Κωδικός Τύπος**

46391	4mm
46394	5mm
46397	6mm
46403	8mm
46409	10mm
46415	12mm
46418	14mm
46421	16mm
46424	18mm
46427	20mm

**Κονδύλι μονόπτερο αλουμινίου**

ART.4414

**Κωδικός Τύπος**

44129	8mm
-------	-----



**Τηλεσκοπικός καθρέπτης**



Κωδικός Μήκος  
6061



**Τηλεσκοπικός καθρέπτης με μαγνήτη**



Κωδικός Μήκος  
617 ≤630mm



**Εύκαμπτη αρπάγη**

για συλλογή αντικειμένων από δύσκολα σημεία

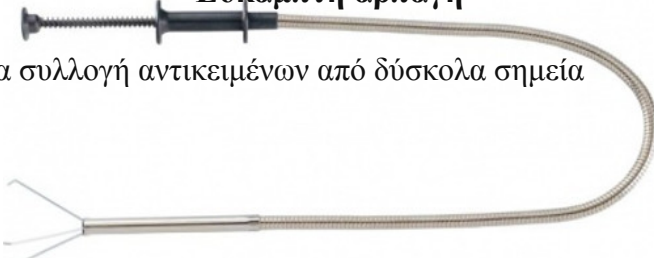

Κωδικός Μήκος  
88901 560mm



**Τηλεσκοπικός μαγνήτης**



Κωδικός Τύπος  
88902 1,6kg



**Εύκαμπτο σπирάλ με μαγνήτη**

για συλλογή αντικειμένων ≤1,6kg από δύσκολα σημεία



Κωδικός Μήκος  
61701 440mm



**Εύκαμπτο σπирάλ με μαγνήτη**

για συλλογή αντικειμένων ≤0,7kg από δύσκολα σημεία



Κωδικός Μήκος  
61702 510mm



**Σετ εργαλείων επιθεώρησης**



Κωδικός  
617A



**Μαγνητιστής - απομαγνητιστής**



Κωδικός  
88601



**Τηλεσκοπικός μαγνήτης με καθρέπτη**

Εύκαμπτος φωτιζόμενος



Κωδικός Μήκος  
617L 530mm



**Θερμόμετρο υπερύθρων**



Κωδικός Τύπος  
9U0401 -20°C - +500°C





### Αλοιφές κοπτικών



**Κωδικός Συσκευασία**

60.1155 125gr

60.1156 750gr



### Λιπαντικό κεριά κοπτικών



**Κωδικός Συσκευασία**

60.1200 350ml



### Σπρέι υγρό κοπής

OLIO TAGLIO



**Κωδικός**

83010/04

**Συσκευασία**

400ml



### Σπρέι τσιμπιδας

ANTIADESIVO  
SALDATURA



**Κωδικός**

80610/04

**Συσκευασία**

400ml



### Σπρέι καλουπιών σιλικονούχο

DISTACCANTE



**Κωδικός**

83610/04

**Συσκευασία**

400ml



### Σπρέι μάντων

ANTISLITTANTE  
CINGHIE



**Κωδικός**

83110/04

**Συσκευασία**

400ml



### Σαπουνέλια



**Κωδικός**

83050/05

**Συσκευασία**

5l



### Σαπουνέλια λευκά



**Κωδικός**

84450/05

**Συσκευασία**

5l



**Σπρέι υπεσυντηρητής 8 λειτουργιών**

W8



Κωδικός	Συσκευασία
81710/02W8	200 ml
81710/04W8D	400 ml
81710/04W8DJ	400 ml Smart

**Eco Service**  
CHEMICAL PRODUCTS  
MADE IN ITALY

**Σπρέι αντισκωριακό**

SUPER SBLOCCANTE



**Κωδικός**  
81710/04  
**Συσκευασία**  
400ml

**Eco Service**  
CHEMICAL PRODUCTS  
MADE IN ITALY

**Σπρέι κατά του σκουριάσματος**

ANTIOSSIDANTE



**Κωδικός**  
85110/04  
**Συσκευασία**  
400ml

**Eco Service**  
CHEMICAL PRODUCTS  
MADE IN ITALY

**Σπρέι σιλικόνης**

SILICONE SPRAY



**Κωδικός**  
80410/04  
**Συσκευασία**  
400ml

**Eco Service**  
CHEMICAL PRODUCTS  
MADE IN ITALY

**Σπρέι λιπαντικό ξηρό τεφλών**

LUBRIFICANTE SECCO



**Κωδικός**  
85210/04  
**Συσκευασία**  
400ml

**Eco Service**  
CHEMICAL PRODUCTS  
MADE IN ITALY

**Σπρέι βαζελίνης**

OLIO VASELINA



**Κωδικός**  
81910/04  
**Συσκευασία**  
400ml

**Eco Service**  
CHEMICAL PRODUCTS  
MADE IN ITALY

**Σπρέι ελέγχου διαρροής αερίου**

RICERCA GAS



**Κωδικός**  
81110/04  
**Συσκευασία**  
400ml

**Eco Service**  
CHEMICAL PRODUCTS  
MADE IN ITALY

**Σπρέι ελέγχου διαρροής αερίων**

GAS CONTROL



**Κωδικός** **Συσκευασία**  
405000 400 ml

**oxyturbo**  
gervani



**Σπρέι γράσο γενικής χρήσης**

GRASSO MILLEUSI



**Κωδικός**  
83810/04  
**Συσκευασία**  
400ml



**Σπρέι γράσο θαλάσσης**  
GRASSO NAUTICA



**Κωδικός**  
83910/04  
**Συσκευασία**  
400ml



**Σπρέι γράσο καδένας**  
GRASSO CATENE



**Κωδικός**  
84010/04  
**Συσκευασία**  
400ml



**Σπρέι γράσο υψηλής θερμοκρασίας 700°C**

GRASSO 700°C



**Κωδικός**  
84110/04  
**Συσκευασία**  
400ml



**Γράσο γενικής χρήσης**  
GRASSO MILLEUSI



Κωδικός	Συσκευασία
83830/125	125 ml
83830/50	500 ml
83830/01	Φυσίγγιο
83830/01	900 γρ
83830/45	4,6 κιλά



**Γράσο βαζελίνης**  
GRASSO VASELINA



**Κωδικός** **Συσκευασία**  
81930/125 125 ml



**Γράσο θαλάσσης**  
GRASSO NAUTICA



Κωδικός	Συσκευασία
83930/125	125 ml
83930/50	500 ml
83930/01	Φυσίγγιο
83930/01	900 γρ



**Γράσο υψηλής θερμοκρασίας**  
GRASSO ALTE TEMPERATURE



**Κωδικός** **Συσκευασία**  
84130/125 125 ml  
84130/01 900 γρ



**Γράσο σιλικόνης**  
GRASSO SILICONICO



**Κωδικός** **Συσκευασία**  
84230/125 125 ml



**Σταντ με σωληνάρια γράσσου 125ml**



**Κωδικός** **Συσκευασία**  
85030/MIX1 30 τεμ.



### Κόλλα στιγμής UNIRAPID



Κωδικός Συσκευασία  
69510/03 3gr



### Εποξική κόλλα σύριγγα ADESIVO EPOSSIDICO



Κωδικός Συσκευασία  
68910/25 25ml



### Κόλλα μετάλλων SALDA METALLI



Κωδικός Συσκευασία  
69310/25 25ml



### Βενζινόκολλα



Κωδικός Συσκευασία  
BALLY CTU 50ml

### Σπρέι κόλλα

COLA SPRAY



Κωδικός Συσκευασία  
81410/04 400ml



### Ασφαλιστικά μπουλονιών 50ml FRENAFILETTI



Κωδικός Τύπος  
67201/50 F1222  
67202/50 F1243  
67203/50 F1270



### Υγρό τεφλόν 50ml PTFE LIQUIDO

PTFE LIQUIDO



Κωδικός Τύπος  
67204/50 572



### Ατσάλοστοκος EPOXY STICK



Κωδικός Συσκευασία  
69010/57 57gr



### Ράβδοι σιλικόνης διαφανείς

Ø11,5mm μήκος 30cm  
Ιξώδες: 8000 ±500 @180°C  
Σημείο πήξης: 82°C  
Χρόνος τήξης: 15-20 sec  
Open time: 20-30 sec  
Θερμοκρασία εφαρμογής:  
140-180°C

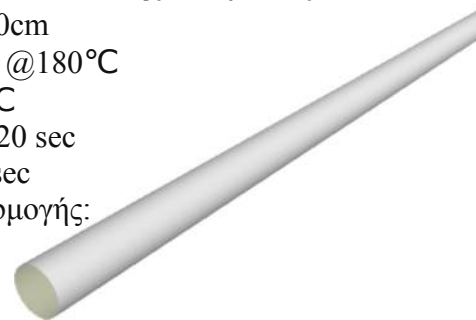

Τύπος  
Κιβώτιο 25 κλών  
Κιλό





**Κόλλα γενικής χρήσης**

VINYLPROF



**Κωδικός Συσκευασία**  
69850/75 750gr



**Καθαριστικά χεριών**

STAR



**Κωδικός Συσκευασία**  
60010/01 1 λίτρο  
60010/04 4 λίτρα



**Καθαριστικό χεριών με αντλία**

PLUS



**Κωδικός Συσκευασία**  
60110/05 5 λίτρα



**Καθαριστικό για ανοξείδωτα**

PULINOX



**Κωδικός Συσκευασία**  
62510/75 750 ml



**Σπρέυ αέρας**

ARIA SPRAY



**Κωδικός Συσκευασία**  
89110/04 400ml



**Σπρέι καθαρισμού  
κλιματιστικών αυτοκινήτου**

ECO CLIMAT



**Κωδικός Συσκευασία**  
84710/04 400ml



**Σπρέι λίπανσης επαφών**

PROTETTIVO CONTATTI



**Κωδικός Συσκευασία**  
83710/02 200 ml



**Σπρέι καθαρισμού επαφών**

PULITORE CONTATTI



**Κωδικός Συσκευασία**  
85710/02 200 ml



**Αποφρακτικό υγρό**

SGORG LIQUIDO



**Κωδικός Συσκευασία**  
61850/01 1l



**Καθαριστικό υγρό**

για σκουριά,  
κονιάματα, άλατα  
PULIMETAL



**Κωδικός Συσκευασία**  
61710/750 750ml



**Αλοιφή γαλίσματος**

SHINE



**Κωδικός Συσκευασία**  
29-100000-0 75 ml



**Αλοιφή γαλίσματος για μέταλλα**

METAL POLISH



**Κωδικός Συσκευασία**  
29-101000-0 75 ml



**Αλοιφή γαλίσματος για inox**

STAINLESS STEEL



**Κωδικός Συσκευασία**  
29-103000-0 75 ml



**Αλοιφή γαλίσματος marine**

MARINE SHINE



**Κωδικός Συσκευασία**  
01-001190 75 ml  
29-106200-0



**Διαλυτικό νίτρου**

DILUENTE



**Κωδικός Συσκευασία**  
60750/01 1l



**Χρώμα ψυχρού γαλβανίσματος 1 κιλό**



**Κωδικός Χρώμα**  
81350/75C Ασημί





## Ακρυλικά σπρέι 400ml

Κωδικός	Χρώμα	Κωδικός	Χρώμα
90010/001P	RAL9005 Μαύρο	90010/011P	RAL1007 Ώχρα
90010/030P	RAL9005 Μαύρο ματ	90010/044P	RAL1023 Κίτρινο
90010/002P	RAL9010 Λευκό	90010/010P	RAL1021 Κίτρινο
90010/031P	RAL9010 Λευκό ματ	90010/028P	RAL1015 Μπεζ
90010/002P	RAL3000 Κόκκινο	90010/015P	RAL6002 Πράσινο
90010/004P	RAL3001 Κόκκινο	90010/022P	RAL6029 Μέντα
90010/013P	RAL3003 Κόκκινο	90010/020P	RAL2004 Πορτοκαλί
90010/027P	RAL3020 Κόκκινο	90010/025P	RAL5003 Μπλε σκούρο
90010/016P	RAL8017 Καφέ	90010/007P	RAL5017 Μπλε
90010/006P	RAL8016 Καφέ	90010/024P	RAL5015 Ουρανό
90010/021P	RAL8011 Καφέ	90010/051P	RAL4006 Μωβ
90010/057P	RAL8003 Καφέ	90010/029P	RAL9006 Αλουμίνιο



## Σπρέι φωσφοριζέ 400ml

FLUORESCENTE

Κωδικός	Χρώμα
70110/101	Κίτρινο
70110/103	Κόκκινο



## Σπρέι μεταλλικό 400ml

EFFECT

Κωδικός	Χρώμα
90310/304P	Χρυσό
90310/304P	Χαλκός
90710/706P	Νίκελ καθρέπτης
90710/705P	Χρυσό καθρέπτης



## Σπρέι υψηλής θερμοκρασίας 400ml

ALTE TEMPERATURE

Κωδικός	Χρώμα
70510/501	Μαύρο γαλιστερό
70510/501	Μαύρο ματ
70510/504	Αλουμίνιο



## Σπρέι σμάλτο 400ml

SPECIAL  
BIANCO  
ELETTRODOMESTICI

Κωδικός	Χρώμα
90610/603P	Λευκό

Σπρέι βαφής για ζάντες 400ml **NEO**SPECIAL  
ALLUMINIO  
RUOTE

Κωδικός	Χρώμα
90610/607P	Αλουμίνιο



## Σπρέι μαγνητικό 400ml

MAGNETIC

Κωδικός	Χρώμα
86110/034	Γκρι



## Σπρέι γαλβανίσματος 400ml

ZINCO CHIARO



**Κωδικός** **Χρώμα**  
81310/04 Γκρι  
λαμπερό



## Σπρέι inox 400ml

ACCIAIO INOX



**Κωδικός** **Χρώμα**  
81810/04



## Σπρέι βερνίκι διαφανές 400ml

SPECIAL TRASPARENTE



**Κωδικός** **Χρώμα**  
90610/601P Γυαλιστερό  
90610/605P Ματ



## Σπρέι αντισκωριακό 400ml

SPECIAL FONDO ANTIRUGGINE GRIGIA



**Κωδικός** **Χρώμα**  
90610/604P Γκρι



## Σπρέι λαστιχόπισσα 500ml

CATRAMIX



**Κωδικός**  
86810/05



## Σπρέι καθαριστικό κινητήρα 400ml

LAVAMOTORI



**Κωδικός**  
82110/04



## Σπρέι καθαρισμού φρένων 500ml

PULITORE FRENI



**Κωδικός**  
82210/04

Σπρέι γράσο κατάλληλο για τρόφιμα 400ml **NEO**

LG1



**Κωδικός**  
86710/04





**Μετροταινία 2m**

KS13



Κωδικός  
530044

**KDS.**

**Μετροταινία 3,5m**

JM19-35



Κωδικός  
562632

**KDS.**

**Μετροταινία 5,5m**

JM19-55



Κωδικός  
552503

**KDS.**

**Μετροταινία 5,5m**

GT25-55



Κωδικός  
562656

**KDS.**

**Μετροταινία 5,5m**

κλίμακα σε εκατοστά & ίντσες  
JM19-55YMEB BP



Κωδικός  
ME5519J

**KDS.**

**Μετροταινία 7,5m**

GT25-75



Κωδικός  
562663

**KDS.**

**Μετροταινία 5,5m**

GGEVO-25-55



Κωδικός  
530259

**KDS.**

**Μετροταινία 7,5m**

GGEVO-25-75



Κωδικός  
530310

**KDS.**

**Μετροταινία 7,5m**

GT27-75 διπλής όψης - τριπλή  
επίστρωση - inox ελατήριο - 4  
περτσίνια

Japan



Κωδικός Τύπος  
GT27-75 27mm

**KDS.**

**Μετροταινία 8m** INOX

SS25-80



Κωδικός Τύπος  
SS2580VBG 25mm

**KDS.**

**Μετροταινία 10m**

ZS25-10



Κωδικός Τύπος  
SME10 25mm

**KDS.**

**Μετροταινίες**

KACLONG 10



Κωδικός Τύπος  
KL10-20 10mmX20m  
KL10-30 10mmX30m

**KDS.**

**Αυτοκόλλητες μεζούρες 13mm**

δεξιές



Κωδικός	Τύπος
562380	1 μέτρο
562397	2 μέτρα
510190	5 μέτρα

**KDS**

**Αυτοκόλλητες μεζούρες 13mm**

αριστερές



Κωδικός	Τύπος
TAIN213L	2 μέτρα
TAIN513L	5 μέτρα

**KDS**

**Αυτοκόλλητες μεζούρες 13mm**

μεσαίες



Κωδικός	Τύπος
TAIN513C	5 μέτρα

**KDS**

**Ρίγες (Πασέτα) INOX**

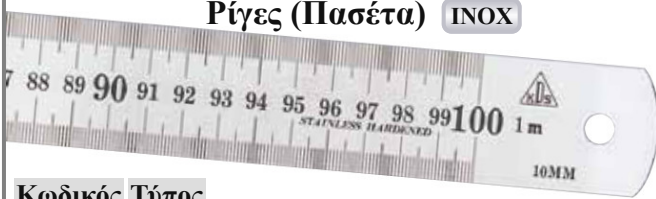

Κωδικός	Τύπος
SSL1500	15cm
SSL300	30cm
539726	60cm
SSL1000	1m

**KDS**

**Μετροταινία PVC**



Κωδικός	Τύπος
24505	50m

**Kapriol**

**Γωνίες σιδηρουργού**

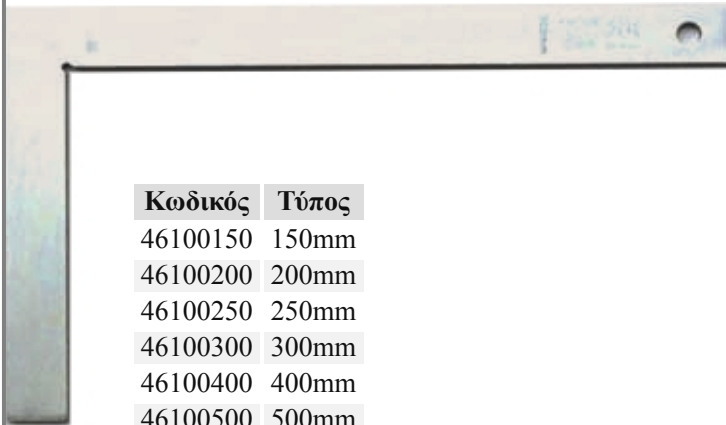

Κωδικός	Τύπος
46100150	150mm
46100200	200mm
46100250	250mm
46100300	300mm
46100400	400mm
46100500	500mm
46100600	600mm
46100800	800mm
461001000	1000mm



**Γωνίες σιδηρουργού με πατούρα**

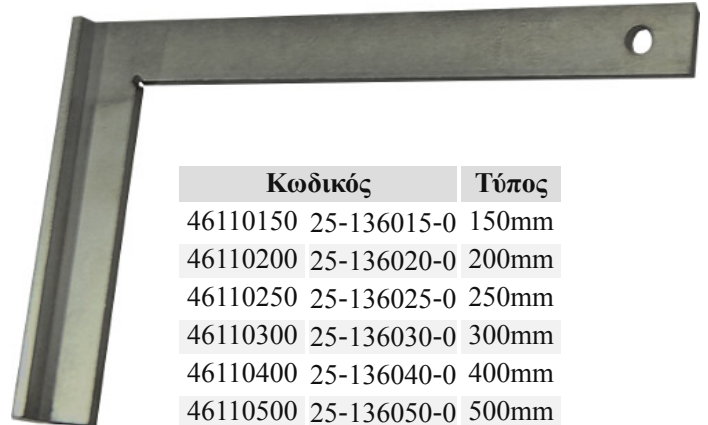

Κωδικός	Τύπος
46110150	25-136015-0 150mm
46110200	25-136020-0 200mm
46110250	25-136025-0 250mm
46110300	25-136030-0 300mm
46110400	25-136040-0 400mm
46110500	25-136050-0 500mm
46110600	25-136060-0 600mm
46110800	25-136080-0 800mm
461101000	25-136010-0 1000mm



**Οδόμετρο αναδιπλούμενο**

WM-10KDX

Με πενταπήφιο μηχανικό μετρητή (4 ακέραια + 1 δεκαδικό).  
Μετράει μέχρι 9999,9 μέτρα.  
Κατασκευή από αλουμίνιο.  
Συνοδεύεται με θήκη μεταφοράς.



Κωδικός	Τύπος
520984	104cm

**KDS**

**Ξύλινα μέτρα δίχρωμα NEO**



Κωδικός	Τύπος
HF 2/10	2m

**SOLA**



**Παχύμετρο**

COLUMBUS



**Κωδικός Τύπος**  
40029 120mm



**Παχύμετρα**

INOX



**Κωδικός Τύπος**  
0188501 150mm  
0184505 200mm  
0184508 300mm



**Παχύμετρο**

INOX



**Κωδικός Τύπος**  
180015 150mm



**Παχύμετρο ψηφιακό**

INOX



**Κωδικός Τύπος**  
150 150mm



**Παχύμετρο ρολόι**

INOX



**Κωδικός Τύπος**  
25-185015-9 150mm



**Παχύμετρο με μεγάλη σιαγόνα 90mm**

INOX



**Κωδικός Τύπος**  
2244522 300mm



**Παχύμετρο σημαδέματος**

INOX



**Κωδικός Τύπος**  
0322501 200mm



**Μικρόμετρα**

INOX



**Κωδικός Τύπος**  
0800501 0-25mm  
0800501 25-50mm  
0800501 50-75mm



### Φύλλερ



Κωδικός	Τύπος
4216013	13 τεμαχίων
4217020	20 τεμαχίων
204126	26 τεμαχίων
25-199120-0	20 τεμ. 0,05-1mm 200mm
25-199130-0	20 τεμ. 0,05-1mm 300mm



### Σπειρόμετρο



Κωδικός	Τύπος
25-209148-9	48 φύλλα
208058	58 φύλλα



### Σετ όργανα μέτρησης



Κωδικός  
5096



### Γωνία Στέλλα



Κωδικός Τύπος  
46100200 200mm



### Μοιρογώνια



Κωδικός Τύπος  
45660120150 150mm  
45660150200 200mm



### Μοιρογώνιο **NEO**



Κωδικός Τύπος  
G012-03-145 195mm



### Εξωτερικά κομπάσα



Κωδικός Τύπος  
47510150 150mm  
47510175 175mm  
47510200 200mm  
47510250 250mm



### Εσωτερικά κομπάσα



Κωδικός Τύπος  
47520150 150mm  
47520175 175mm  
47520200 200mm  
47520250 250mm



### Διαβήτες



Κωδικός Τύπος  
25-168515-0 150mm  
47209175 175mm  
25-171017-9 175mm  
με ρύθμιση  
25-168520-0 200mm  
25-168525-0 250mm  
47209300 300mm





**Εξολκείς μηχανικών με τρία σκέλη εξωτερικός**  
Μέγιστο βάθος: 147mm



**Κωδικός Τύπος**  
66625 7-140mm



**Εξολκείς μηχανικών με τρία σκέλη εσωτερικός**  
Μέγιστο βάθος: 140mm



**Κωδικός Τύπος**  
66624 23-130mm



**Εξολκείς με δύο σκέλη εσωτερικοί - εξωτερικοί**



**Κωδικός Τύπος**  
6590103 3"  
6590104 4"  
6590106 6"  
6590108 8"



**Εξολκείς με τρία σκέλη εσωτερικοί - εξωτερικοί**





**Κωδικός Τύπος**  
6590203 3"  
6590204 4"  
6590206 6"  
6590208 8"



**Εξολκείς δίποδοι**





**Κωδικός**    
36/1 10-55mm 40mm  
36/2 10-75mm 65mm



**Εξολκείς τρίποδοι**





**Κωδικός**    
37/1 10-55mm 40mm  
37/2 10-75mm 65mm



**Εξολκείς δίποδοι**





**Κωδικός**    
28/1 20-170mm 130mm  
28/2 20-230mm 200mm



**Εξολκείς τρίποδοι**



**Κωδικός**    
29/1 20-170mm 130mm  
29/2 20-230mm 200mm



## Εξολκείς δίποδοι



**BUCO**  
Made in Germany

## Κωδικός



20/1	20-150mm	80mm
20/2	40-200mm	130mm

## Εξολκείς τρίποδοι



**BUCO**  
Made in Germany

## Κωδικός



21/1	20-150mm	80mm
21/2	40-200mm	130mm

## Εξολκείας δίποδος



Κωδικός	Τύπος
65910	40-90mm

**FORCE**

## Εξολκείς δίποδοι

## Κωδικός



22/01	15-85mm	85mm
22/0	20-120mm	120mm
22/1	20-165mm	145mm
22/2	35-230mm	220mm
22/3	50-300mm	270mm
22/4	50-400mm	400mm
22/5	50-500mm	500mm



**BUCO**  
Made in Germany

## Εξολκείς τρίποδοι

## Κωδικός



23/01	15-85mm	85mm
23/0	20-120mm	120mm
23/1	20-165mm	145mm
23/2	35-230mm	220mm
23/3	50-300mm	270mm
23/4	50-400mm	400mm
23/5	50-500mm	500mm



**BUCO**  
Made in Germany

## Εξολκείς μηχανικών με τρία σκέλη εξωτερικοί



Κωδικός	Τύπος
65910090	90mm
65910130	130mm
65910160	160mm
65910200	200mm
65910250	250mm

**FORCE**

## Σταντ με εξολκείς σειράς 16



Κωδικός
16/ST

**BUCO**  
Made in Germany

## Εξολκείς δίποδοι εξωτερικοί

## Κωδικός

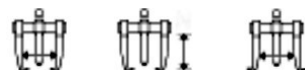

16/1	25-80mm	100mm	70-130mm
16/1A	25-130mm	100mm	80-180mm
16/2	50-160mm	150mm	105-220mm
16/2A	60-200mm	150mm	120-270mm
16/3	80-250mm	200mm	160-330mm
16/3A	80-350mm	200mm	160-420mm
16/4	110-520mm	200mm	195-600mm



**BUCO**  
Made in Germany

## Πόδια για εξολκείς τεμάχιο

## Κωδικός



16A-200	200mm
16A-300	300mm
16A-400	400mm



**BUCO**  
Made in Germany



### Δίποδο σετ εξολκείων



Κωδικός



S16/0A 130mm 100-200-250mm  
S16/2AS 200mm 150-300mm



### Τρίποδο σετ εξολκείων



Κωδικός



S17/0A 130mm 100-200-250mm



### Εξολκείς ακρόμπαρων

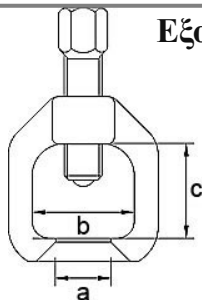

Κωδικός	A	B	C
180/2	18mm	37mm	37mm
180/3	23mm	45mm	45mm
180/4	29mm	55mm	60mm
180/5	39mm	70mm	80mm



### Εξολκείς ακρόμπαρων



Κωδικός	Τύπος
628E18	18mm
628E23	23mm
628E29	29mm
628E40	40mm
628E46	46mm



### Εξολκείας ακρόμπαρων



Κωδικός	Τύπος
183/1	Ø22mm



### Εξολκείας ακρόμπαρων



Κωδικός	Τύπος
185/1	12-50mm
185/2	60-80mm



### Εξολκείας ακρόμπαρων



Κωδικός	Τύπος
62802	Ø20mm



### Εξολκείας ακρόμπαρων



Κωδικός	Τύπος
62805	Ø20mm



## Καρυδάκια εξολκείς μπουζονιών

Κωδικός	Καρέ	Τύπος	Μήκος
81805	3/8	5mm	60mm
81806	1/2	6mm	60mm
81807	1/2	7mm	60mm
81808	1/2	8mm	60mm
81810	1/2	10mm	68mm
81812	1/2	12mm	68mm
81814	1/2	14mm	68mm



**FORCE**  
Made in Germany

## Καρυδάκια εξολκείς μπουζονιών

Κωδικός	Μήκος
75/6	6mm
75/8	8mm
75/10	10mm
75/12	12mm



**BUCO**  
Made in Germany

## Εξολκείας μπουζονιών



Κωδικός	Τύπος
71/1	Ø4-13mm

**BUCO**  
Made in Germany

## Εξολκείας μπουζονιών

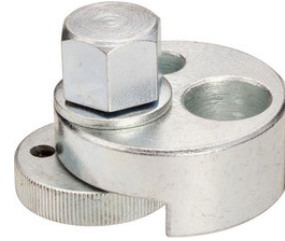

Κωδικός	Τύπος
74	Ø4-19mm

**BUCO**  
Made in Germany

## Εξολκείας αδρανείας



Κωδικός
54/1

**BUCO**  
Made in Germany

## Εξολκείας αδρανείας



Κωδικός
54/2

**BUCO**  
Made in Germany

## Κόφτες παξιμαδιών



Κωδικός	Μήκος
220/1	4-10mm
220/2	10-18mm
220/3	18-27mm

**BUCO**  
Made in Germany

## Πηρούνες εξολκείων



Κωδικός	Ανοιγμα
190/1	18mm
190/2	23mm
190/3	29mm

**BUCO**  
Made in Germany

## Λεβιέδες ελαστικών



Κωδικός	Μήκος
2111/3	300mm
2111/4	400mm
2111/5	500mm
2111/6	600mm

**BUCO**  
Made in Germany

## Λεβιέδες ελαστικών



Κωδικός	Τύπος
750200	200mm 162gr
750300	300mm 370gr
750380	380mm 556gr
750500	500mm 732gr
750650	650mm 1160gr

**FORCE**  
Made in Germany

**Εξολκείας ρουλεμάν**

Κωδικός	Τύπος
50/02	5-6mm
50/01	6-8mm
50/0	8-12mm
50/1	12-16mm
50/2	16-20mm
50/3	20-27mm
50/3A	24-30mm
50/4	27-36mm
50/5	36-46mm
50/6	46-58mm
50/7	58-70mm
50/8	70-100mm

**BUCO**  
Made in Germany**Γέφυρα πιάτων ρουλεμάν**

Κωδικός	Τύπος
62/0	45-110mm 110mm 60/0, 61/0
62/1	55-140mm 155mm 60/1, 61/1
62/2	45-110mm 110mm 60/2, 61/2
62/3	55-140mm 155mm 60/3, 61/3
62/4	45-110mm 110mm 60/4, 61/4

**BUCO**  
Made in Germany**Πιάτα για ρουλεμάν**

Κωδικός	Τύπος
60/0	5-60mm
60/1	12-75mm
60/2	22-115mm
60/3	30-155mm
60/4	40-280mm

**BUCO**  
Made in Germany**Εξολκείας ρουλεμάν επίπεδος**

Κωδικός	Εύρος	Βίδα	Οπή
666050	30-50mm	3/8"x24x125mm	3/8"x16t
666075	50-75mm	1/2"x20x135mm	3/8"x16t
666105	75-105mm	1/2"x16x165mm	5/8"x18t

**FORCE****Εξολκείας σεντ επίπεδος**

- ο 4 προεκτάσεις εξάγωνες με σπείρωμα 14mmx102mm
- ο 4 προεκτάσεις εξάγωνες με σπείρωμα 17mmx127mm
- ο 1 κοχλίας πίεσης 175mm<sup>9</sup>/16"
- ο Γέφυρα

Κωδικός  
66610**FORCE****Εξολκείας ρουλεμάν οπής**

Κωδικός	Τύπος
66619	12-38mm 1/2"-1 1/2" 920gr

**FORCE****Μαγνητική βάση ωρολογιού**Βάρος: 1370gr  
Ελκτική δύναμη: 80kgΚωδικός  
891B01**FORCE****Σεντ εξαγωγής φθαρμένων παξιμαδιών - μπουλωνιών**

8-9-10-11-12-13-14-15-16-17-18-19mm



Κωδικός	Τύπος
912U8	σεντ 12 τεμαχίων

**FORCE**

## Εξολκείς ελατηρίων



Κωδικός	Τύπος
909/1	12-75mm
909/2	22-115mm
909/3	30-155mm

**BUCO**  
Made in Germany

## Εξολκείς ελατηρίων ζεύγος

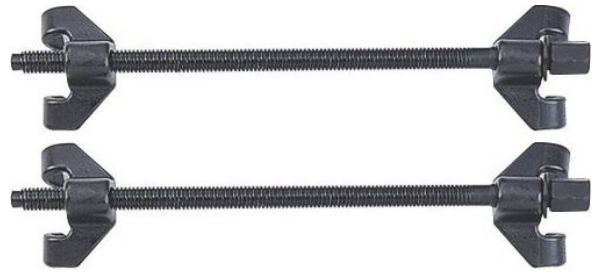

Κωδικός	Τύπος
627270	270mm
627370	370mm

**FORCE**

## Εξολκείς ελατηρίων

Ύψος: 240mm



Κωδικός	Τύπος
910/K	110-180mm

**BUCO**  
Made in Germany

## Γέφυρες εσωτερικών εξολκείων



Κωδικός	Τύπος
55/1	
55/2	
55/3	

**BUCO**  
Made in Germany

## Ανάστροφα κολαούζα σετ



Κωδικός	Τύπος
4709003	5 τεμάχια
4709013	6 τεμάχια

**RENNSTEIG**

## Εξολκείας - ανάστροφο κολαούζο



Κωδικός	Τύπος
4700063	No6

**RENNSTEIG**

## Εξολκείς - κολαούζα σετ



Κωδικός	Τύπος
4719003	5 τεμάχια

**RENNSTEIG**

## Εξολκείς - κολαούζα



Κωδικός	Τύπος
47110013	N1
47110023	N2
47110033	N3
47110043	N4
47110053	N5
47110063	N6

**RENNSTEIG**



## Σφιγκτήρες ελατηρίων εμβόλων



Κωδικός	Τύπος
6203125	Ø53-125mm 3"
6203175	Ø90-175mm 3"
6204175	Ø90-175mm 4"



## Σφιγκτήρες ελατηρίων εμβόλων



Κωδικός	Τύπος
115001	No 0
115002	No 1
115202	No 2
115202A	No 2A
115203	No 3



## Εξολκείες βαλβίδων



Κωδικός	Τύπος
62104	



## Εξολκείες βαλβίδων



Κωδικός	Τύπος
116029	70-225X290



## Τραβηχτήρια σύρματος (καρκίνι)



Κωδικός	Τύπος
9200013	1-3mm
9200014	1-4mm
9200015	1-5mm
9200018	1-8mm
30-561012-0	1-12mm



## Τραβηχτήρια σύρματος νέου τύπου



Κωδικός	Τύπος
30-560001-0	1-5mm 500kg
30-560006-0	3-9mm 1000kg
30-560016-0	4-12mm 1700kg
30-560050-0	6-18mm 3000kg



## Βεντούζες λείανσης βαλβίδων αυτοκινητού



Κωδικός	Τύπος
1182020 23-127520-0	Ø20
1182025 23-127525-0	Ø25
1182030 23-127530-0	Ø30
1182037 23-127537-0	Ø37
115000	Λεβιές



## Εξολκείες βολάν μοτο



Κωδικός	Τύπος
9Y0186	M30x1,5



**Σετ εξολκείας αδρανείας**

Κωδικός  
665B

**FORCE**

**Σετ εξολκείας αδρανείας**

Κωδικός  
664

**FORCE**

**Σετ εξολκείας υδραυλικός**

Κωδικός  
66622

**FORCE**

**Σετ εξολκείας υδραυλικός**

Κωδικός  
66601

**FORCE**

**Συμπιεσόμετρο αερίου κυλίνδρων**

Για βενζινοκίνητα  
Με ταχυσύνδεσμο και βαλβίδα απελευθέρωσης  
4 αντάπτορες: 10x1,00 - 12x1,25 - 14x1,25 - 18x1,5  
Κλίμακα: 0-300psi, 0-21kg/cm<sup>2</sup>

Κωδικός  
908G1



**FORCE**

**Συμπιεσόμετρο για κινητήρες Diesel**

- ο Με ταχυσύνδεσμο και βαλβίδα απελευθέρωσης
- ο Εύκαμπτος σωλήνας 355mm
- ο 5 αντάπτορες προθερμαντήρων:  
10x1,00x119mm - 10x1,25x735mm - 10x1,75x114mm  
12x1,25x54mm - 14x1,25x72mm
- ο 3 ομοιώματα μπεκ ψεκασμού: 20x1,50 - 24x2,00x64mm
- ο Ομοίωμα μπεκ ψεκασμού 114mm
- ο Γόνατο 90° πλάκα - σφυγκτήρας - σετ ροδέλες
- ο Διπλή κλίμακα: 0-1000psi - 0-70bar
- ο Κατάλληλο για: FORD ROVER MERCEDES TOYOTA VW NISSAN BMW RENAULT MAZDA MITSUBUSHI PEUGEOT OPEN FIAT CITROEN LAND ROVER SEAT LEYLAND DAF VOLVO VAUXHALL DACIA DAIHATSU ISUZU

Κωδικός  
913G1



**FORCE**



### Σταυρός επιβατικών αυτοκινήτων

πτυσσόμενος



17mm-19mm-21mm-1/2"

Κωδικός Τύπος

681400 400mm 1490gr



### Σετ επιδιόρθωσης ελαστικών

- ο Εργαλείο με αξονάκι οπής για τοποθέτηση κορδονιού
- ο Εργαλείο με αξονάκι λίμας για τον καθαρισμό της οπής του ελαστικού
- ο Ανταλλακτικό αξονάκι με οπή
- ο Ανταλλακτικό αξονάκι με λίμα
- ο Σετ 5 τεμάχια κορδόνια επισκευής



Κωδικός

904T4



### Ανταλλακτικά κορδόνια επισκευής ελαστικών

5 τεμάχια



Κωδικός

904T4-P



### Εργαλείο σύσφιξης σφυγκτήρων ημιαξονίου

- ο Για την τοποθέτηση σφυγκτήρων inox νέου τύπου που απαιτείται υψηλή δύναμη
- ο Υποδοχή στο καρδάκι 3/8 Vape
- ο Κατάλληλο για: VW AUDI SEAT SKODA OPEL VAUXHALL FORD



Κωδικός

62527



### Πρέσα πείρων αλυσίδας



Κωδικός Τύπος

9Y0135 225mm 720gr



### Ακουστικά μηχανών



Κωδικός Τύπος

9G2204 200gr



### Εργαλείο τοποθέτησης ρουλεμάν & τσιμουχών

- ο Αλουμινένιο σώμα
- ο Περιστρεφόμενη λαβή και δυνατότητα σύσφιξης της επιθυμητής διαμέτρου
- ο Ικανότητα τοποθέτησης: 18,5-89mm - 0,72-3,5"



Κωδικός

9U0301



### Εξολκέας βολάν μηχανής

- ο Διαστάσεις: M27x1,0
- ο Κατάλληλος για: HONDA, SUZUKI, YAMAHA, KAWASAKI, KTM
- ο Βάρος: 250gr



Κωδικός

9Y0181



**Πένσες διακοπής ροής κολάρων 3 τεμάχια** **NEO**

**Κωδικός** **Τύπος**  
903G12 10-15-24mm

**Εύκαμπτη πένσα σφικτήρων** **NEO**

**Κωδικός** **Τύπος**  
9G0201 10-100mm

**Εργαλείο κλειδώματος εκκεντροφόρου** **NEO**

Volkswagen, Seat και Skoda Diesel, Rover και Land Rover Diesel, Renault και Fiat με διπλό έκκεντρο, Ford Zetec, Citroen και Peugeot κλπ.



**Κωδικός** **Τύπος**  
9G0606

**Εργαλείο εξαγωγής ράουλου δυναμού Bosch** **NEO**

Audi, BMW, Ford, Seat, Mercedes, Skoda, Volkswagen, Porsche κλπ.



**Κωδικός** **Τύπος**  
674 M10

**Πυκνόμετρο δοκιμής αντιψυκτικού**

**Κωδικός** **Τύπος**  
9G4001

**Πιστόλια αέρος**

Πίεση λειτουργίας 5,5 έως 8,5 bar  
Σπείρωμα εισόδου 1/4" θηλυκό



**Κωδικός** **Τύπος**  
9U0202 100mm (κοντό)  
9U0203 340mm (μακρύ)



**Σετ συμπιεστές ελατηρίων αμορτισέρ**

Κωδικός	Τύπος
	Ø80-Ø115mm
908T5	Ø110-Ø150mm
	Ø140-Ø195mm

**Κρουστικό κατσαβίδι με αρσενικό καρέ 1/2"**  
\*χρειάζεται τον αντάπτορα 81045 για τις μύτες 5/16"

Κωδικός	Τύπος
8174	1/2"

**Κρουστικό κατσαβίδι σε κασετίνα**

Περιέχει 4 μύτες 5/16"



Κωδικός	Τύπος
5064	5/16"

**Σφυροκατσάβιδο σετ**

9mm 11mm PH2 PH3 PZ2 PZ3 T25 T30 T40 T45 T50



Κωδικός	Τύπος
5171	1/2" 17 τεμάχια

**Μύτες σφυροκατσάβιδων Phillips 5/16"** 

Κωδικός	Τύπος
278022	PH2X32
278032	PH3X32
278042	PH4X32

**Μύτες σφυροκατσάβιδων Pozidriv 5/16"** 

Κωδικός	Τύπος
278122	PZ2X32
278132	PZ3X32
278142	PZ4X32

**Μύτες σφυροκατσάβιδων ίσιες 5/16"** 

Κωδικός	Τύπος
278322	8X1,6
278332	10X1,6
278342	12X2

**Μύτες σφυροκατσάβιδων Torx 5/16"** 

Κωδικός	Τύπος
278202	T25X32
278212	T27X32
278222	T30X32
278232	T40X32
278242	T45X32
278252	T50X32
278272	T55X32



## Περτιναδόρος



Κωδικός Τύπος  
HR-702 2,4 - 4,8 mm



## Περτιναδόρος



Κωδικός Τύπος  
HR-705 2,4 - 4,8 mm



## Περτιναδόρος Β/Τ



Κωδικός Τύπος  
THR-11E 2,4 - 4,8 mm



## Επαγγελματικός περτιναδόρος

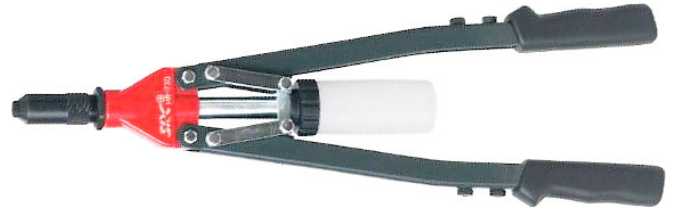

Κωδικός Τύπος  
HR-730 2,4 - 6,4 mm



## Περτιναδόρος για περτσίνια με πάσο



Κωδικός Τύπος  
HN-02 M4-M10



## Περτιναδόρος για περτσίνια με σπείρωμα



Κωδικός Τύπος  
5861 M3-M6



## Περτιναδόρος χειρός

για περτσίνια με σπείρωμα



Αλουμίνιο: M3x0,50-M8x1,25  
Χάλυβας: M3x0,50-M6x1,00  
Inox: M3x0,50-M5x0,80

Κωδικός Τύπος  
678N260 250mm 640gr



## Περτιναδόροι αέρος



Κωδικός Τύπος  
SRC-55P 3,2-4,8mm  
SRC-56P 4-6,5mm



**Περτσίνια αλουμινίου**

↓Μήκος↓	3mm	4mm	4,8mm	6mm
6				
8				
10				
12				
14				
16				
18				
20				
25				
30				

**Περτσίνια αλουμινίου φαρδιά**

Κωδικός	Διαστάσεις
PF4812	4,8X12
PF4816	4,8X16
PF4820	4,8X20

**Περτσίνια σιδήρου με πάσο**

Κωδικός	Πάσο
PS4007	M4x0,7
PS5008	M5x0,8
PS6010	M6x1,0
PS8015	M8x1,25
PS1015	M10x1,5
PS1217	M12x1,75

**Αυτόματος κεντραδόρος**

Κωδικός  
5096P2

**Κεντραδόροι**

Κωδικός	Τύπος
4301000	100mm
4301200	120mm

**Ζουμπάδες**

Κωδικός	Τύπος	Κωδικός	Τύπος
4500020	2mm	4500070	7mm
4500030	3mm	4500080	8mm
4500040	4mm	4500100	10mm
4500050	5mm		
4500060	6mm		

**Ζουμπάδες σετ**

Κωδικός	Τύπος
4251700	3-10mm

**Ζουμπάς ρομπότ**

Κωδικός  
4451365



## Χτυπητά γράμματα Λατινικά



Κωδικός	Τύπος
943002	2mm
943003	3mm
943004	4mm
943005	5mm
943006	6mm
943008	8mm
9430010	10mm



## Χτυπητά γράμματα Ελληνικά



Κωδικός	Τύπος
943202	2mm
943203	3mm
943204	4mm
943205	5mm
943206	6mm
943208	8mm
9432010	10mm



## Στένσιλ με Ελληνική αλφάβητο



Κωδικός	Τύπος
540040	40mm
540060	60mm
540080	80mm
540012	120mm



## Στένσιλ με Λατινική αλφάβητο



Κωδικός	Τύπος
541004	40mm
541006	60mm
541008	80mm
541012	120mm



## Χτυπητοί αριθμοί



Κωδικός	Τύπος
943322	2mm
943323	3mm
943324	4mm
943325	5mm
943326	6mm
943328	8mm
9433210	10mm
9432012	12mm



## Στένσιλ με αριθμούς



Κωδικός	Τύπος
542004	40mm
542006	60mm
542008	80mm
542012	120mm





### Ξύστρα φλαντζών



**Κωδικός**

46326009



### Ξύστρα φλαντζών **NEO**



**Κωδικός Τύπος**

905M2P3 25x160mm



### Σγκρόπιες

Κωδικός	Τύπος	Κωδικός	Τύπος	Κωδικός	Τύπος	Κωδικός	Τύπος
7650001	1mm	7650014	14mm	7650027	27mm	7655040	40mm
7650002	2mm	7650015	15mm	7650028	28mm	7655041	41mm
7650003	3mm	7650016	16mm	7650029	29mm	7655042	42mm
7650004	4mm	7650017	17mm	7650030	30mm	7655043	43mm
7650005	5mm	7650018	18mm	7650031	31mm	7655044	44mm
7650006	6mm	7650019	19mm	7650032	32mm	7655045	45mm
7650007	7mm	7650020	20mm	7650033	33mm	7655046	46mm
7650008	8mm	7650021	21mm	7650034	34mm	7655047	47mm
7650009	9mm	7650022	22mm	7650035	35mm	7655048	48mm
7650010	10mm	7650023	23mm	7655036	36mm	7655049	49mm
7650011	11mm	7650024	24mm	7655037	37mm	7655050	50mm
7650012	12mm	7650025	25mm	7655038	38mm		
7650013	13mm	7650026	26mm	7655039	39mm		



### Φλαντζοκόφτες

**Κωδικός Τύπος**

71850200 200mm

71850300 300mm

71850400 400mm

71850600 600mm

71850800 800mm



## Σετ κολαούζα

Κωδικός	Τύπος	Κωδικός	Τύπος	Κωδικός	Τύπος	Κωδικός	Τύπος
02040	2X0,40	12125	12X1,25	18125	18X1,25	30350	30X3,50
25045	2,5X0,45	12150	12X1,50	18150	18X1,50	32150	32X1,50
03050	3X0,50	12175	12X1,75	18175	18X1,75	32350	32X3,50
04070	4X0,70	13075	13X0,75	18200	18X2,00	33200	33X2,00
05080	5X0,80	13100	13X1,00	18250	18X2,50	33350	33X3,50
06075	6X0,75	13125	13X1,25	20150	20X1,50	34150	34X1,50
06100	6X1,00	13150	13X1,50	20200	20X2,00	36150	36X1,50
07100	7X1,00	13175	13X1,75	20250	20X2,50	36200	36X2,00
08075	8X0,75	14100	14X1,00	22150	22X1,50	36400	36X4,00
08100	8X1,00	14125	14X1,25	22200	22X2,00	38150	38X1,50
08125	8X1,25	14150	14X1,50	22250	22X2,50	39400	39X4,00
08150	8X1,50	14175	14X1,75	24150	24X1,50	40150	40X1,50
09100	9X1,00	14200	14X2,00	24200	24X2,00	42150	42X1,50
09125	9X1,25	15100	15X1,00	24300	24X3,00	42450	42X4,50
09150	9X1,50	15125	15X1,25	26150	26X1,50		
10100	10X1,00	15150	15X1,50	26300	26X3,00		
10125	10X1,25	16100	16X1,00	27150	27X1,50		
10150	10X1,50	16125	16X1,25	27200	27X2,00		
11100	11X1,00	16150	16X1,50	27300	27X3,00		
11125	11X1,25	16175	16X1,75	28150	28X1,50		
11150	11X1,50	16200	16X2,00	30150	30X1,50		
12100	12X1,00	18100	18X1,00	30200	30X2,00		



## Σετ κολαούζα και φιλιέρες (μετρικό)

⊗ Προσωρινά μη διαθέσιμο

Άγνωστη η ημερομηνία νέας παραλαβής



Κωδικός	Τύπος
725	M3-M10
726	M4-M12

Σετ κολαούζα **αριστερόστροφα**

Κωδικός	Τύπος
CL05080	5X0,80
CL06100	6X1,00
CL08125	8X1,25
CL10100	10X1,00
CL10150	10X1,50
CL10175	10X1,75
CL12125	12X1,25
CL12150	12X1,50
CL12175	12X1,75
CL14150	14X1,50
CL14200	14X2,00
CL16150	16X1,50
CL16200	16X2,00
CL18150	18X1,50
CL18250	18X2,50
CL20150	20X1,50
CL20250	20X2,50
CL22150	22X1,50
CL22250	22X2,50
CL24150	24X1,50
CL24200	24X2,00
CL24300	24X3,00





## Σετ κολαούζα ίντσας UNC - BSW



Κωδικός	Τύπος	Κωδικός	Τύπος
CUNC03240	1/8"X40	CUNC14012	9/16"X12
CUNC04032	5/32"X32	CUNC15811	5/8"X11
CUNC04724	3/16"X24	CUNC19010	3/4"X10
CUNC06320	1/4"X20	CUNC22209	7/8"X9
CUNC07918	5/16"X18	CUNC28608	1"X8
CUNC09516	3/8"X16	CUNC28607	1 1/8"X7
CUNC11014	7/16"X14	CUNC31707	1 1/4"X7
CUNC12712	1/2"X12	CUNC38106	1 1/2"X6
CUNC12713	1/2"X13		



## Σετ κολαούζα ίντσας ψιλόπασα UNF



Κωδικός	Τύπος	Κωδικός	Τύπος
CUNF04732	3/16"X32	CUNF12722	1/2"X22
CUNF06328	1/4"X28	CUNF14016	9/16"X16
CUNF07924	5/16"X24	CUNF14018	9/16"X18
CUNF07932	5/16"X32	CUNF15816	5/8"X16
CUNF09516	3/8"X18	CUNF15811	5/8"X18
CUNF09520	3/8"X20	CUNF19016	3/4"X16
CUNF09522	3/8"X22	CUNF22214	7/8"X14
CUNF09524	3/8"X24	CUNF25412	1"X12
CUNF09532	3/8"X32	CUNF25414	1"X14
CUNF11020	7/16"X20	CUNF28612	1 1/8"X12
CUNF12716	1/2"X16	CUNF31712	1 1/4"X12
CUNF12720	1/2"X20	CUNF38112	1 1/2"X12

Κολαούζο ίντσας UNC **NEO**

Κωδικός	Τύπος	Κωδικός	Τύπος
75514	1/4"	75526	5/8"
75516	5/16"	75530	3/4"
75518	3/8"	75534	7/8"
75522	1/2"		

Κολαούζο ίντσας BSW **NEO**

Κωδικός	Τύπος
71522	1/2"



## Σετ κολαούζα σωλήνων ίντσας BSP



Κωδικός	Τύπος	Κωδικός	Τύπος
BSP03228	1/8"X28	BSP22214	7/8"X14
BSP06319	1/4"X19	BSP25411	1"X11
BSP09519	3/8"X19	BSP31711	1 1/4"X11
BSP12714	1/2"X14	BSP38111	1 1/2"X11
BSP15814	5/8"X14	BSP50811	2"X11
BSP19014	3/4"X14		



## Κολαούζα σωλήνων κοντά εξάγωνα στη μέση BSP



Κωδικός	Τύπος
67871	1/4"
67872	3/8"
67873	1/2"
67874	3/4"
67875	1"



**Κολαούζο ελικοειδές 150mm**

Για φυσικό αέριο



Κωδικός	Τύπος
32036	M6X1,00

**VÖLKEL****Κολαούζα παραγωγής για inox**

Κωδικός	Τύπος
35226	M3*0,50mm
35230	M4*0,70mm
35234	M5*0,80mm
35238	M6*1,00mm
35242	M8*1,25mm
35246	M10*1,50mm
35250	M12*1,75mm

**VÖLKEL****Τρυπανοκολαούζα μακριά**

Τετράγωνο καρέ



Κωδικός	Τύπος
37026	M3*0,50mm
37030	M4*0,70mm
37034	M5*0,80mm
37038	M6*1,00mm
37042	M8*1,25mm
37046	M10*1,50mm
37050	M12*1,75mm

**VÖLKEL****Ελικοειδή κολαούζα μακριά**

Κωδικός	Τύπος
38726	M3*0,50mm
38730	M4*0,70mm
38734	M5*0,80mm
38738	M6*1,00mm
38742	M8*1,25mm
38746	M10*1,50mm
38750	M12*1,75mm

**VÖLKEL****Σετ τρυπανοκολαούζα με καρέ 1/4"**

Κωδικός	Τύπος
67200	3-10mm

**VÖLKEL****Τρυπανοκολαούζα με καρέ 1/4"**

Κωδικός	Τύπος
67226	M3X0,5
67230	M4X0,7
67234	M5X0,8
67238	M6X1,0
67242	M8X1,25
67246	M10X1,5

**VÖLKEL**

**Κολαούζα παραγωγής HSS**

Κωδικός	Τύπος	Κωδικός	Τύπος
37516	M2*0,40mm	38550	M12*1,75mm
37522	M2,5*0,45mm	38554	M14*2mm
37526	M3*0,50mm	38558	M16*2mm
37528	M3,5*0,60mm	38562	M18*2,5mm
37530	M4*0,70mm	39540	M20*1,5mm
37534	M5*0,80mm	38566	M20*2,5mm
37538	M6*1,00mm	39545	M22*1,5mm
37540	M7*1,00mm	38570	M22*2,5mm
37542	M8*1,25mm	38574	M24*3mm
37546	M10*1,50mm		

**VÖLKEL****Σετ κολαούζα αριστερόστροφα**

Κωδικός	Τύπος
27026	M3*0,50mm
27030	M4*0,70mm
27034	M5*0,80mm
27038	M6*1,00mm
27042	M8*1,25mm
27046	M10*1,50mm
27050	M12*1,75mm
27054	M14*2,00mm
27058	M16*2,00mm
27062	M18*2,50mm
27066	M20*2,50mm

**VÖLKEL****Κολαούζα κοντά εξάγωνα στη μέση**

Κωδικός	Τύπος	Κωδικός	Τύπος	Κωδικός	Τύπος
67727	M12*1,00mm	67740	M15*1,00mm	67761	M20*1,50mm
67728	M12*1,25mm	67741	M15*1,50mm	67762	M20*2,00mm
67729	M12*1,50mm	67744	M16*1,00mm	67054	M20*2,50mm
67050	M12*1,75mm	67745	M16*1,25mm	67769	M22*1,50mm
67732	M13*1,00mm	67746	M16*1,50mm	67770	M22*2,00mm
67733	M13*1,50mm	67052	M16*2,00mm	67055	M22*2,50mm
67737	M14*1,25mm	67753	M18*1,50mm	67769	M24*1,50mm
67738	M14*1,50mm	67754	M18*2,00mm	67770	M24*2,00mm
67051	M14*2,00mm	67053	M18*2,50mm	67056	M24*3,00mm

**VÖLKEL****Κολαούζα παραγωγής ψιλόπασα**

Κωδικός	Τύπος
39411	8X1mm
39415	10X1mm
39416	10X1,25mm
39421	12X1,25
39422	12X1,5
39427	14X1,25
39428	14X1,5
39433	16X1,5
39436	18X1,5

**VÖLKEL****Κολαούζα NPT**

Κωδικός	Τύπος
63512	1/8"
63514	1/4"
63516	3/8"
63518	1/2"

**VÖLKEL****Κολαούζα σωλήνος**

Κωδικός	Τύπος
78412	1/8"
78414	1/4"
78416	3/8"
78418	1/2"
78422	3/4"

**VÖLKEL****Κολαούζα ελικοειδή μακριά**

Κωδικός	Τύπος
36230	M4*0,70mm
36242	M8*1,25mm

**VÖLKEL**

## Φιλιάρες Ø38 - Ø50

Κωδικός	Τύπος	Κωδικός	Τύπος	Κωδικός	Τύπος
CD02040	2X0,40	CD12100	12X1,00	CD22250	22X2,50
CD25045	2,5X0,45	CD12125	12X1,25	CD24150	24X1,50
CD025145	3X0,50	CD12150	12X1,50	CD24200	24X2,00
CD04070	4X0,70	CD12175	12X1,75	CD24300	24X3,00
CD05080	5X0,80	CD14100	14X1,00	CD26150	26X1,50
CD06075	6X0,75	CD14125	14X1,25	CD26300	26X3,00
CD06100	6X1,00	CD14150	14X1,50	CD27200	27X2,00
CD07100	7X1,00	CD14200	14X2,00	CD27300	27X3,00
CD08100	8X1,00	CD16100	16X1,00	CD28150	28X1,50
CD08125	8X1,25	CD16125	16X1,25	CD30150	30X1,50
CD08150	8X1,50	CD16150	16X1,50	CD30350	30X3,50
CD09100	9X1,00	CD16200	16X2,00	CD32150	32X1,50
CD09125	9X1,25	CD18150	18X1,50	CD32350	32X3,50
CD10100	10X1,00	CD18200	18X2,00	CD33150	33X1,50
CD10125	10X1,25	CD18250	18X2,50	CD34150	34X1,50
CD10150	10X1,50	CD20150	20X1,50	CD36150	36X1,50
CD11100	11X1,00	CD20200	20X2,00	CD36400	36X4,00
CD11125	11X1,25	CD20250	20X2,50	CD38150	38X1,50
CD11150	11X1,50	CD22150	22X1,50		



## Φιλιάρες

Κωδικός	Τύπος	Κωδικός	Τύπος
27430	4X0,7mm	26456	14X1,50mm
27438	6X1,00mm	27454	14X2,00mm
27442	8X1,25mm	26466	16X1,50mm
26436	10X1,00mm	27458	16X2,00mm
26438	10X1,25mm	26472	18X1,50mm
27446	10X1,50mm	26474	18X2,00mm
26446	12X1,25mm	27462	18X2,50mm
26448	12X1,50mm	26484	20X1,50mm
27450	12X1,75mm		



Φιλιάρες Ø38 - Ø50 **αριστερόστροφες**

Κωδικός	Τύπος	Κωδικός	Τύπος
CDL04070	4X0,70	CDL14150	14X1,50
CDL05080	5X0,80	CDL14200	14X2,00
CDL06100	6X1,00	CDL16150	16X1,50
CDL07100	7X1,00	CDL16200	16X2,00
CDL08100	8X1,00	CDL18150	18X1,50
CDL08125	8X1,25	CDL18250	18X2,50
CDL10100	10X1,00	CDL20150	20X1,50
CDL10125	10X1,25	CDL20250	20X2,50
CDL10150	10X1,50	CDL22150	22X1,50
CDL12125	12X1,25	CDL22250	22X2,50
CDL12150	12X1,50	CDL24150	24X1,50
CDL12175	12X1,75	CDL24300	24X3,00





## Φιλίρες ίντσας UNC Ø38 - Ø50



Κωδικός	Τύπος	Κωδικός	Τύπος
DUNC03240	1/8"X40	DUNC14012	9/16"X12
DUNC04032	5/32"X32	DUNC15811	5/8"X11
DUNC04724	3/16"X24	DUNC19010	3/4"X10
DUNC06320	1/4"X20	DUNC22209	7/8"X9
DUNC07918	6/16"X18	DUNC28608	1"X8
DUNC09516	3/8"X16	DUNC28607	1 1/8"X7
DUNC11014	7/16"X14	DUNC31707	1 1/4"X7
DUNC12712	1/2"X12		
DUNC12713	1/2"X13		



## Φιλίρες ίντσας ψιλόπασης UNF Ø38 - Ø50



Κωδικός	Τύπος	Κωδικός	Τύπος
DUNF04732	3/16"X32	DUNF15818	5/8"X18
DUNF06328	1/4"X28	DUNF19016	3/4"X16
DUNF07924	5/16"X24	DUNF22214	7/8"X14
DUNF09524	3/8"X24	DUNF25412	1"X12
DUNF11020	7/16"X20	DUNF25414	1"X14
DUNF12720	1/2"X20		
DUNF14018	9/16"X18		



## Φιλίρες σωλήνων σε ίντσες BSP Ø38 - Ø50



Κωδικός	Τύπος	Κωδικός	Τύπος
DBSP03228	1/8"X28	DBSP22214	7/8"X14
DBSP06319	1/4"X19	DBSP25411	1"X11
DBSP09519	3/8"X19	DBSP31711	1 3/4"X11
DBSP12714	1/2"X14	DBSP38111	1 1/2"X11
DBSP15814	5/8"X14	DBSP50811	2"X11
DBSP19014	3/4"X14		

Φιλίρες Ø25 **NEO**

Κωδικός	Τύπος	Κωδικός	Τύπος
D2502040	2X0,40mm	D2508125	8X1,25mm
D25025045	2,5X0,45mm	D2509100	9X1,00mm
D2503050	3X0,50mm	D2509125	9X1,25mm
D2504070	4X0,70mm	D2510100	10X1,00mm
D2505080	5X0,80mm	D2512125	12X1,25mm
D2506075	6X0,75mm	D25121250	12X1,50mm
D2508100	8X1,00mm		

Φιλίρες Ø25 **αριστερόστροφες** **NEO**

Κωδικός	Τύπος
DL2508100	8X1,00mm
DL2510100	10X1,00mm
DL2508125	8X1,25mm
DL2512125	12X1,25mm
DL25121250	12X1,50mm
DL25121275	12X1,75mm

Φιλίρες ίντσας ψιλόπασης UNC Ø25 **NEO**

Κωδικός	Τύπος
DUNC250403	5/32"X32
DUNC250472	3/16"X24
DUNC250632	1/4"X20
DUNC250951	3/8"X16
DUNC251101	7/16"X14



## Μανέλες κολαούζων



Κωδικός	Τύπος
CMK00	No0 1/16"-1/4" M1-M6
CMK04	No4 1/16"-1/2" M3-M12
CMK05	No5 3/19"-1/2" M4-M12
CMK06	No6 1/4"-3/4" M6-M20
CMK07	No7 3/8"-1" M8-M25



## Μανέλες κολαούζων



Κωδικός	Τύπος	Καρέ
13010	No 1	2-6,3mm
13015	No 1.1/2	2,1-8mm
13020	No 2	3-9mm
13030	No 3	4,9-12mm
13040	No 4	5,5-16mm
13050	No 5	7-20mm



## Μανέλες κολαούζων ατσάλινες



Κωδικός	Τύπος
14010	No 1
14020	No 2
14030	No 3
14040	No 4
14050	No 5



## Καστάνιες κολαούζων



Κωδικός	Τύπος
24-127001-0	M3-8
24-127002-0	M5-12



## Καστάνιες κολαούζων μακριές



Κωδικός	Τύπος
24-129010-0	3-8
24-129020-0	5-12 300mm



## Προεκτάσεις κολαούζων



Κωδικός	Τύπος
14534	M4
14549	M4,5-M6
14555	M9-M10
14562	M11
14570	M12
14580	M10
14590	M14-M16



## Μανέλες φιλιέρας



Κωδικός	Τύπος
CMF254	1"
CMF381	1 1/2"
CMF508	2"
CMF636	2 1/2"



## Μανέλες φιλιέρας



Κωδικός	Τύπος	Τύπος
15002	Ø20*5mm	M3-M4
15003	Ø20*7mm	M4,5-M6
15004	Ø25*9mm	M7-M9
15005	Ø30*11mm	M10-M11
15007	Ø38*14mm	M12-M14
15008	Ø45*14mm	M16-M20
15009	Ø45*18mm	M16-M20 BSW
DS50	Ø50mm	
DS55	Ø55mm	
DS65	Ø65mm	



**Ελατήρια επιδιόρθωσης πάσων 1D**

Κωδικός	Τύπος
07208	M5*0,80
07209	M6*1,00
07211	M8*1,25
07216	M10*1,25
07219	M10*1,50
07223	M12*1,25
07222	M12*1,50
07221	M12*1,75
07225	M14*2,00
07234	M16*2,00
07236	M18*2,50
07239	M20*2,50

**VÖLKEL****Ελατήρια επιδιόρθωσης πάσων 1,5D**

Κωδικός	Τύπος
07308	M5*0,80
07309	M6*1,00
07311	M8*1,25
07316	M10*1,25
07319	M10*1,50
07323	M12*1,25
07322	M12*1,50
07321	M12*1,75
07327	M14*1,25
07326	M14*1,50
07325	M14*2,00
07335	M16*1,50
07334	M16*2,00
07338	M18*1,50
07336	M18*2,50
07341	M20*1,50
07339	M20*2,50

**VÖLKEL****Ελατήρια επιδιόρθωσης πάσων 2D**

Κωδικός	Τύπος
07408	M5*0,80
07409	M6*1,00
07439	1/4"
07411	M8*1,25
07416	M10*1,25
07419	M10*1,50
07423	M12*1,25
07422	M12*1,50
07421	M12*1,75
07427	M14*1,25
07426	M14*1,50
07425	M14*2,00
07435	M16*1,50
07434	M16*2,00
07438	M18*1,50
07436	M18*2,50
07441	M20*1,50
07439	M20*2,50

**VÖLKEL****Λεβιές εισαγωγής ελατηρίου**

Κωδικός	Τύπος
08008	M5*0,80 3
08009	M6*1,00 9
08011	M8*1,00 11
	M8*1,25 11
	M10*1,00 13
08013	M10*1,25 13
	M10*1,50 13
	M12*1,25 15
08015	M12*1,50 15
	M12*1,75 15
08017	M14*1,25 17
08016	M14*1,50 16
	M14*2,00 16
08018	M16*1,50 18
	M16*2,00 18
	M20*1,50 21
08021	M20*2,00 21
	M20*2,50 21

**VÖLKEL****Κολαούζο επιδιόρθωσης σπειρωμάτων**

Κωδικός	Τύπος	Κωδικός	Τύπος	Κωδικός	Τύπος
03008	M5*0,80	03020	M12*1,75	03040	M20*1,50
03009	M6*1,00	03029	M14*1,25	03039	M20*2,00
03012	M8*1,00	03028	M14*1,50	03038	M20*2,50
03011	M8*1,25	03027	M14*2,00		
03017	M10*1,00	03034	M16*1,50		
03016	M10*1,25	03033	M16*2,00		
03015	M10*1,50	03037	M18*1,50		
03022	M12*1,25	03036	M18*2,00		
03021	M12*1,50	03035	M18*2,50		

**VÖLKEL**

Κιτ επιδιόρθωσης σπειρωμάτων 1,5D

VCOIL

Κωδικός	Τύπος	Κωδικός	Τύπος	Κωδικός	Τύπος
04007	M4*0,70	04021	M12*1,75	04038	M20*2,00
04009	M5*0,80	04030	M14*1,25	04037	M20*2,50
04010	M6*1,00	04029	M14*1,50	04042	M22*1,50
04013	M8*1,00	04028	M14*2,00	04045	M24*1,50
04012	M8*1,25	04033	M16*1,50		
04018	M10*1,00	04032	M16*2,00		
04017	M10*1,25	04036	M18*1,50		
04016	M10*1,50		M18*2,00		
04023	M12*1,25	04034	M18*2,50		
04016	M12*1,50	04039	M20*1,50		



VÖLKEL

Κώνοι

Κωδικός	Τύπος
CB1202	B12X2
CB1602	B16X2
CB1603	B16X3
CB1802	B18X2
CB1803	B18X3
CB2203	B22X3
CB2204	B22X4



RÖHM

Φωλιές

Κωδικός	Τύπος
H0201	2X1
H0302	3X2
H0402	4X2
H0403	4X3
H0504	5X4



RÖHM

Κλειδιά τσοκ



Κωδικός	Τύπος
KS2A	13mm
KS3	16mm
KS4	20mm

RÖHM

Σφηνοβγάλτες



Κωδικός	Τύπος
BO102	1&2
BO303	3

RÖHM

Αντάπτορας SDS-Plus για τσοκ 1/2"



Κωδικός  
264000002

KEIL

Αντάπτορας από SDS-Plus σε SDS-MAX

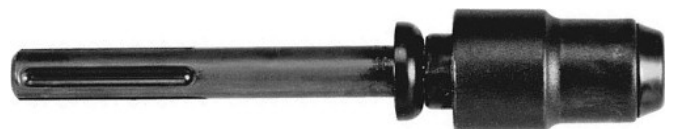

Κωδικός  
265150000

KEIL

**Τσοκ τόννου με 3 μορσέτα**

\*Κατασκευάζονται υπό την εποπτεία της Rohm



Κωδικός	Τύπος
6350Φ80	Ø80
6350Φ100	Ø100
6350Φ125	Ø125
6350Φ160	Ø160
6350Φ200	Ø200
6350Φ250	Ø250
6350Φ315	Ø315

**Πόντες τόννου**

Γερμανίας



Κωδικός	Τύπος
MK1	MK1
MK2	MK2
MK3	MK3
MK4	MK4
MK5	MK5
MT03	MT3 B'
MT04	MT4 B'
MT05	MT5 B'

**Τσοκ δραπάνου EXTRA**

Κωδικός	Τύπος
ERV10095	1-10 3/8"-24
ERV1012	1-10 1/2"-20
ERV13095	1,5-13 3/8"-24
ERV13127	1,5-13 1/2"-20

**Τσοκ δραπάνου αυτόματα Supra-SK**

Βαρέως τύπου



Κωδικός	Τύπος
SK13127	1-13 1/2"-20

**Τσοκ δραπάνου με κλειδί**

Κωδικός	Τύπος	Κωδικός	Τύπος
P08095	0,5-8 3/8"-24	P13B16	1,5-13 B16
P10095	0,8-10 3/8"-24	P16127	3-16 1/2"-20
P10127	1-10 1/2"-20	P16158	1-16 5/8"-16
P10B12	1-10 B12	P16B16	3-16 B16
P13095	1,5-13 3/8"-24	P16B18	3-16 B18
P13127	1,5-13 1/2"-20	P20B22	5-20 B22
P13B12	1,5-13 B12		

**Τσοκ δραπάνου αυτόματα**

Κωδικός	Τύπος	Κωδικός	Τύπος
	0,5-8 3/8"-24	S16127	3-16 1/2"-20
S10095	0,5-10 3/8"-24	S165816	3-16 5/8"-16
S10127	0,5-10 1/2"-20	S16B16	3-16 B16
S10B12	0,5-10 B12	S16B18	3-16 B18
S13095	1-13 3/8"-24		3-16 B16 BT
S13127	1-13 1/2"-20		3-16 B18 BT
871046	1-13 B12		
S13B16	1-13 B16		



**Δυναμόκλειδο για καρυδάκια 1/4"**

Το 64721605 έχει υποδοχή για μανέλα

**Κωδικός** **Τύπος**

64721602 0,4-2Nm

64721605 1-5Nm

**Δυναμόκλειδο για καρυδάκια 1/4"****Κωδικός** **Τύπος**

6472195W 3-15Nm

**Δυναμόκλειδο για καρυδάκια 1/4"****Κωδικός** **Τύπος**

6472295 6-30Nm

**Δυναμόκλειδο με καρέ 1/4"****Κωδικός** **Τύπος**

6472290W 5-25Nm

**Δυναμόκλειδο με καρέ 3/8"****Κωδικός** **Τύπος**

6473295 6-30Nm

**Δυναμόκλειδο με καρέ 3/8"****Κωδικός** **Τύπος**

6473360W 10-50Nm

**Δυναμόκλειδο με καρέ 3/8"****Κωδικός** **Τύπος**

6473380 20-110Nm

**Δυναμόκλειδο με καρέ 1/2"****Κωδικός** **Τύπος**

6474535 40-210Nm





Δυναμόκλειδο με καρέ 1/2"



Κωδικός Τύπος  
6474405W 20-100Nm



Δυναμόκλειδο με καρέ 1/2"



Κωδικός Τύπος  
6474500W 20-200Nm



Δυναμόκλειδο με καρέ 1/2"



Κωδικός Τύπος  
6474595W 60-300Nm



Δυναμόκλειδο με καρέ 1/2"



Κωδικός Τύπος  
6474680W 80-400Nm



Δυναμόκλειδο με καρέ 3/4"



Κωδικός Τύπος  
6476970W 100-550Nm



Δυναμόκλειδο σετ



Κωδικός Τύπος  
64713 6-30Nm



Δυναμόκλειδο σετ



Κωδικός Τύπος  
64715 20-100Nm



Δυναμόκλειδο σετ



Κωδικός Τύπος  
64705 40-210Nm



## Πολλαπλασιαστής ροπής 1:3,4



Κωδικός	Τύπος
65108	1/2" Θ - 1/2" Α 176-600 NM
65109	1/2" Θ - 3/4" Α 235-800 NM



## Πολλαπλασιαστές ροπής 1:5



Κωδικός	Τύπος	Μέγιστη είσοδος	Μέγιστη έξοδος
65106	1/2" F 3/4" M	260Nm	1300Nm
65107	3/4" F 1" M	540Nm	2700Nm

## Γωνιόμετρα ροπής σφιξίματος



Κωδικός	Τύπος
9G1802	1/2"
9G1802A	3/4"



## Ηλεκτρονικό δυναμόκλειδο αντάπτορας 1/2"

- Δυνατότητα λειτουργίας με μανέλα ή κασάνια
- Ανάγνωση ροπής την στιγμή της λειτουργίας
- Αυτόματος μηδενισμός μετά τη σύσφυξη
- Υψηλής ακρίβειας ±2%
- Εύρος ροπής 30-260 ft-lb 40-350Nm
- Δεξιόστροφη - αριστερόστροφη λειτουργία
- 10 μνήμες τοποθέτησης
- Δυνατότητα επιλογής:  
Nm, Ft-lb, In-lb, kg-m, kg-cm



Κωδικός	Τύπος
647G4075	76mm 290gr





## Σφυγκτήρες "Π" γαλβανιζέ



Κωδικός	Διαστάσεις	Πάσο	Άνοιγμα
26-199050-0	4x13mm	M6	42mm
26-199075-0	6x16mm	M8	68mm
26-199010-0	6x16mm	M8	92mm



## Μάνδαλα με ρυθμζόμενο εύρος



Κωδικός	Τύπος
XV3-50	55mm
XV5-100	100mm



## Σφυγκτήρες μαραγκών Kliklamp



Κωδικός	Τύπος
MBCKLI12	120mm
MBCKLI16	160mm
MBCKLI20	200mm
MBCKLI25	250mm



## Σφυγκτήρες μαραγκών από Zama



Κωδικός	Τύπος
BCLM15/5	50X150mm
BCLM20/5	50X200mm
BCLM25/5	50X250mm
BCLM30/5	50X300mm



## Σφυγκτήρες μαραγκών από χυτοσίδηρο



Κωδικός	Τύπος
TG20B8	80X200mm
TG25B8	80X250mm
TG30B8	80X300mm



## Σφυγκτήρες μαραγκών από χυτοσίδηρο



Κωδικός	Τύπος
TG20	100X200mm
TG25S10	100X250mm
TG30S10	100X300mm
TG40S10	100X400mm
TG50S10	100X500mm



## Σφυγκτήρες μαραγκών από χυτοσίδηρο



Κωδικός	Τύπος
TG25	120X250mm
TG30S12	120X300mm
TG40S12	120X400mm
TG50S12	120X500mm
TG60S12	120X600mm
TG80S12	120X800mm
TG100S12	120X1000mm
TGK125	120X1250mm
TGK150	120X1500mm
TKPN200BE	120X2000mm
TGK250	120X2500mm
TGK300	120X3000mm



## Σφυγκτήρες μαραγκών από χυτοσίδηρο



Κωδικός	Τύπος
TGRC40	175X400mm
TGRC50S17	175X500mm
TGRC60S17	175X600mm
TGRC80S17	175X800mm
TGRC100S17	175X1000mm



## Σφυγκτήρες παραγκών από χυτοσίδηρο



Κωδικός	Τύπος
TGN40T20	200X400mm
TGN60T20	200X600mm
TGN80T20	200X800mm
TGN100T20	200X1000mm



## Σφυγκτήρες παραγκών από χυτοσίδηρο



Κωδικός	Τύπος
TGN40T25	250X400mm
TGN60T25	250X600mm
TGN80T25	250X800mm
TGN100T25	250X1000mm



## Σφυγκτήρες - τεντωτήρες



Κωδικός	Τύπος
EZ15-6	150X60mm
EZ30-6	300X60mm

EZS15-8	150X80mm
EZS30-8	300X80mm
EZS45-8	450X80mm
EZS60-8	600X80mm



## Σφυγκτήρες παραγκού καστανίας



Κωδικός	Μήκος	Βάθος
G25S10H	250mm	100mm
G30S10H	300mm	100mm
G40S10H	400mm	100mm
GSH50	500mm	100mm

G30H	300mm	120mm
G40H	400mm	120mm
G50H	500mm	120mm
G60H	600mm	120mm

GSH30	300mm	140mm
-------	-------	-------



## Σφυγκτήρες παραγκού μεγάλης αντοχής με προφίλ τύπου 'H'

20% μεγαλύτερη δύναμη. Σύσφιξη μέχρι 6000N

Κωδικός	Τύπος
GZ16K	160mm
GZ20K	200mm
GZ25K	250mm
GZ30K	300mm
GZ40K	400mm
GZ50K	500mm
GZ60K	600mm
GZ80K	800mm
GZ100K	1000mm



## Σφυγκτήρες παραγκού για δύσκολα σημεία

Σύσφιξη μέχρι 2000N.

Γρήγορη αποδέσμευση



Κωδικός	Τύπος
GK15	150mm
GK30	300mm
GK45	450mm
GK60	600mm



## Σφυγκτήρας με φρένο σαγωνιού



Κωδικός	Τύπος
KRE-30K	300mm
KRE-60K	600mm
KRE-80K	800mm



## Σφυγκτήρας για σωλήνα 3/4"

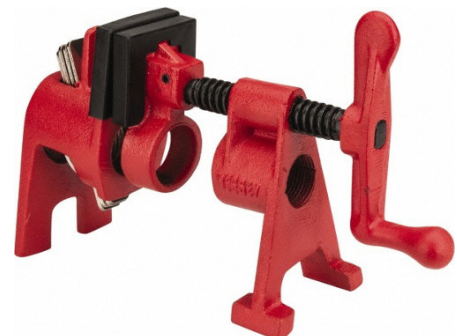

Κωδικός
BPC-H34



**Μόρσες δραπάνου**

Ελαφρού τύπου

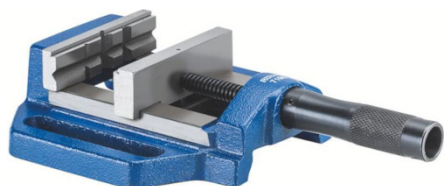

Κωδικός	Τύπος
BSH1 7193	60mm
BSH2 7194	80mm
BSH3 7196	100mm

**Μόρσες δραπάνου**

Βαρέως τύπου



Κωδικός	Τύπος
BSH4 7197	80mm
BSH5 7201	100mm
BSH6 7202	120mm
BSH7 7207	140mm

**Διπλός σφιγκτήρας μόρσα για σύνδεση ντουλαπιών**

Κωδικός	Τύπος
FRZ12	80-120mm

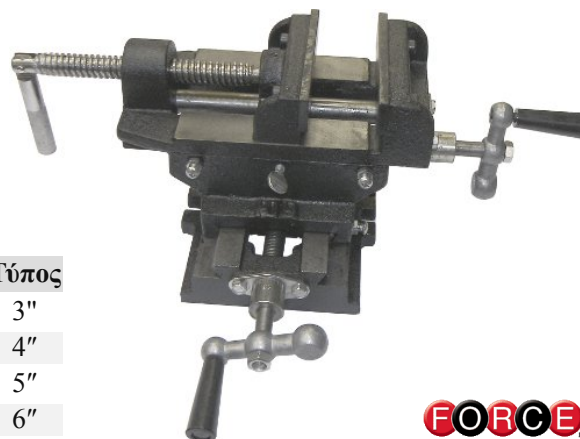
**Σαπόρτ**

Κωδικός	Τύπος
6540503	3"
6540504	4"
6540505	5"
6540506	6"

**Μόρσες ελαφρού τύπου**

Κωδικός	Τύπος
MEDM5-80	75mm
MEDM5-100	100mm

**Μόρσες περιστρεφόμενες**

Κωδικός	Τύπος
6540204A	100mm
6540205A	125mm
6540206A	150mm
6540208A	200mm

**Αμόνια χυτά**

Κωδικός	Τύπος
MEDM215-10	10kg
MEDM215-20	20kg
MEDM215-25	25kg



**Μόρσες ατσάλινες ΝΕΟ**

Fortisimo



Κωδικός	Τύπος	Κωδικός	Τύπος
60210020100	100mm	60210020150	150mm
60210020115	115mm	60210020175	175mm
60210020125	125mm	60210020200	200mm
60210020135	135mm		

**KANCA**  
 DESIGN • FORGE • SAFETY
**Μόρσες υδραυλικών ατσάλινες ΝΕΟ**

Fortisimo plumber



Κωδικός	Τύπος
6026020502125	125mm
6026020502135	135mm
6026020502150	150mm

**KANCA**  
 DESIGN • FORGE • SAFETY
**Μόρσες πάγκου περιστρεφόμενες ατσάλινες ΝΕΟ**

Finemechanic's Vice



Κωδικός	Τύπος
60210300050	50mm
60210300075	75mm

**KANCA**  
 DESIGN • FORGE • SAFETY



## Λειαντικά δρασάνου με σμυριδόπανο

SFL

Κωδικός	Τύπος	Grit	Κωδικός	Τύπος	Grit
A2200010103080	10X10mm	80	A2200050206060	50X20mm	60
	15X10mm	60	A2200050206080	50X20mm	80
A2200015153080	15X15mm	80	A2200050206120	50X20mm	120
	20X15mm	60	A2200050306060	50X30mm	60
	20X20mm	60	A2200050306080	50X30mm	80
	20X25mm	60	A2200050306120	50X30mm	120
A2200025156080	25X15mm	80	A2200060206060	60X20mm	60
A2200025256080	25X25mm	80	A2200060206080	60X20mm	80
A2200030156060	30X15mm	60	A2200060206120	60X20mm	120
A2200030156080	30X15mm	80	A2200060306060	60X30mm	60
A2200030156120	30X15mm	120	A2200060306080	60X30mm	80
A2200030206060	30X20mm	60	A2200060306120	60X30mm	120
A2200030206080	30X20mm	80	A2200060406060	60X40mm	60
A2200030206120	30X20mm	120	A2200060406080	60X40mm	80
	30X30mm	60	A2200060406120	60X40mm	120
A2200040206060	40X20mm	60	A2200080306060	80X30mm	60
A2200040206080	40X20mm	80	A2200080306080	80X30mm	80
A2200040206120	40X20mm	120	A2200080306120	80X30mm	120
A2200040306060	40X30mm	60	A2200080406060	80X40mm	60
A2200040306080	40X30mm	80	A2200080406080	80X40mm	80
	40X30mm	120	A2200080406150	80X40mm	150

**LUKAS**

## Λειαντικά δρασάνου με φλιν

SFV

Κωδικός	Τύπος
A2203050306104	50X30mm
A2203050406104	50X40mm
A2203060406104	60X40mm
	80X30mm
A2203080406104	80X40mm
A2203080506104	80X50mm

**LUKAS**

## Λειαντικά δρασάνου με φλιν και σμυριδόπανο

SFM

Κωδικός	Τύπος
A2204050206104	50X20mm
A2204050306106	50X30mm
A2204050406104	50X40mm
A2204060406104	60X40mm
	80X30mm
A2204080406104	80X40mm
	80X50mm

**LUKAS**

## Λειαντήρες κυλίνδρων - τρίφτες βαλβίδων

Κωδικός	Τύπος
9G0902	Ø19-63,5mm
9G0901	Ø50-178mm

**FORCE**

## Ανταλλακτικές πέτρες

Για τους λειαντήρες κυλίνδρων - τρίφτες βαλβίδων



Κωδικός	Τύπος
9G0902S	5X28,5mm
9G0901S	10X100mm

**FORCE**

## Συρματόβουρτσες πινέλο



Κωδικός	Τύπος
BA1200E	Ø12mm
BA1500E	Ø15mm
BA1900E	Ø19mm
BC2600E	Ø26mm
BBC9078	Ø26mm blister



## Συρματόβουρτσες πινέλο

πλαστικοποιημένες



Κωδικός	Τύπος
451.160	10mm
452.160	16mm
453.160	22mm
456.160	28mm



## Συρματόβουρτσες ίσιες με άξονα



Κωδικός	Τύπος
BDER9348	Ø50mm
BDER9448	Ø60mm
BDER9548	Ø75mm
BDER9648	Ø100mm



## Συρματόβουρτσες ίσιες με άξονα INOX



Κωδικός	Τύπος
415.362	Ø50mm-10
416.362	Ø60mm-10
416.363	Ø60mm-14
417.362	Ø70mm-12
417.363	Ø70mm-16
418.362	Ø80mm-12
418.363	Ø80mm-18
41Z.362	Ø100mm-14
41Z.363	Ø100mm-19

Συρματόβουρτσες ίσιες με άξονα  
πλαστικοποιημένες

Κωδικός	Τύπος
415.160	Ø50mm
416.160	Ø60mm
417.160	Ø76mm

Βούρτσες πλαστικές  
πινέλο με άξονα

Κωδικός	Τύπος	Grit
CNA9422	Ø25mm	80
CNA9522	Ø25mm	150

Βούρτσες πλαστικές ίσιες με άξονα  
INOX

Κωδικός	Τύπος	Grit
CNA9475	Ø75mm	80
CNA9575	Ø75mm	150



## Συρματόβουρτσες καμπίνα με άξονα INOX

Κωδικός	Τύπος
434.365	Πλαστικό 40X20mm καπάκι
435.365	Πλαστικό 50X25mm καπάκι
435.362	Μεταλλικό 50X10mm καπάκι
437.362	Μεταλλικό 70X15mm καπάκι



## Συρματόβουρτσες ίσιες με άξονα INOX



Κωδικός	Τύπος
CDE97510Z	Ø75mm - 10mm
CDE97500Z	Ø75mm - 15mm



**Συρματόβουρτσες καμπάνα με άξονα**

Κωδικός	Τύπος
BTE9168	Ø50mm
BTE9268	Ø75mm

**Συρματόβουρτσες δίδυμου τροχού**

Κωδικός	Τύπος
CT1205E99	Ø125mm
CT1507E99	Ø150mm
CT1705E99	Ø175mm
CT1707E99	Ø175mm-27
CT2006E99	Ø200mm
CT2506E99	Ø250mm

**Συρματόβουρτσα τροχού ανοικτή καμπάνα**

Κωδικός	Τύπος
HSD0100EM14	Ø100mm

**Συρματόβουρτσες τροχού ανοικτές καμπάνα σγουρές**

Κωδικός	Τύπος
HSK0100EM14	Ø100mm
HSK0100KM14	Ø100mm
HSK0120KM14	Ø120mm

**Συρματόβουρτσες τροχού καμπάνα**

Κωδικός	Τύπος
TO0600EM14	Ø60mm
TO0800EM14	Ø80mm
TO1000EM14	Ø100mm

**Συρματόβουρτσες τροχού καμπάνα**

Με κοτσίδες



Κωδικός	Τύπος
TT0601LM14	Ø60mm
TT0601JM14	Ø60mm
TT0801LM14	Ø80mm
TT1001LM14	Ø100mm

**Συρματόβουρτσες τροχού καμπάνα με κοτσίδες**

Κωδικός	Τύπος
CAM1501KM14	Ø150mm
CAM1701KM14	Ø175mm

**Συρματόβουρτσες τροχού ίσιες σγουρές**

Κωδικός	Τύπος
HSR0115KM1	Ø115mm



Συρματόβουρτσες τροχού καμπάνα **INOX**

Κωδικός	Τύπος
421.367	Ø60mm
423.367	Ø75mm
426.367	Ø100mm

**LESSMANN®**  
THE GERMAN BRUSH COMPANY

Συρματόβουρτσες τροχού ίσιες **INOX**

Κωδικός	Τύπος
422.367	Ø100mm

**LESSMANN®**  
THE GERMAN BRUSH COMPANY

Συρματόβουρτσες τροχού ίσιες **INOX**

Με κοτσίδες



Κωδικός	Τύπος
471.757	Ø100mm

**LESSMANN®**  
THE GERMAN BRUSH COMPANY

Συρματόβουρτσες τροχού καμπάνα **INOX**

Με κοτσίδες



Κωδικός	Τύπος
482.717	Ø65X18mm
484.217	Ø80X14mm
480.717	Ø80X18mm
486.217	Ø100X14mm

**LESSMANN®**  
THE GERMAN BRUSH COMPANY

## Συρματόβουρτσες καμπάνα ίσιες



Κωδικός	Τύπος
98101	65mm
98102	75mm

**PEGATEC®**  
HIGH PERFORMANCE ABRASIVES

## Συρματόβουρτσες καμπάνα ζιγυρές



Κωδικός	Τύπος
98301	65mm
98302	75mm

**PEGATEC®**  
HIGH PERFORMANCE ABRASIVES

## Συρματόβουρτσες δίδυμου τροχού



Κωδικός	Τύπος
98403	125X16mm
98404	150X18mm
98405	175X20mm
98406	200X20mm

**PEGATEC®**  
HIGH PERFORMANCE ABRASIVES

## Συρματόβουρτσες ανοικτή καμπάνα



Κωδικός	Τύπος
98802	100X21mm ίσια
98902	100X21mm ζιγυρή

**PEGATEC®**  
HIGH PERFORMANCE ABRASIVES

### Συρματόβουρτσα ορειχάλκινη



Κωδικός  
182.331

LESSMANN®  
THE GERMAN BRUSH COMPANY

### Συρματόβουρτσα ορειχάλκινη

3 σειρών



Κωδικός  
88360

REINER  
ECO  
DINGES

### Λαβές τουμπόβουρτσας



Κωδικός	Τύπος	Κωδικός	Τύπος
566.603	4mm	567.601	1/2"
566.601	6mm	567.603	3/8"

LESSMANN®  
THE GERMAN BRUSH COMPANY

### Τουμπόβουρτσες νάιλον



Κωδικός	Τύπος	Κωδικός	Τύπος
501.801	Ø6mm	500.816	Ø16mm
500.808	Ø8mm	500.818	Ø18mm
500.810	Ø10mm	500.819	Ø19mm
500.812	Ø12mm	500.820	Ø20mm
500.813	Ø13mm	500.822	Ø22mm
500.814	Ø14mm	500.825	Ø25mm
500.815	Ø15mm		

LESSMANN®  
THE GERMAN BRUSH COMPANY

### Τουμπόβουρτσες με σκληρή τρίχα



Κωδικός	Τύπος	Κωδικός	Τύπος
L10	Ø10mm	L30	Ø30mm
L12	Ø12mm	L35	Ø35mm
L13	Ø13mm	L40	Ø40mm
L14	Ø14mm	L45	Ø45mm
L15	Ø15mm	L50	Ø50mm
L16	Ø16mm	L55	Ø55mm
L18	Ø18mm	L60	Ø60mm
L20	Ø20mm	L65	Ø65mm
L25	Ø25mm	L70	Ø70mm

JAZ®

### Τουμπόβουρτσες με διπλό τύλιγμα



Κωδικός	Τύπος
526.130	Ø30mmX160X100mm
526.144	Ø44mmX160X100mm
526.150	Ø50mmX160X100mm
526.157	Ø57mmX160X100mm
526.169	Ø69mmX160X100mm
526.175	Ø75mmX160X100mm
526.188	Ø88mmX160X100mm

LESSMANN®  
THE GERMAN BRUSH COMPANY

### Τουμπόβουρτσες με λεπτή τρίχα



Κωδικός	Τύπος	Κωδικός	Τύπος
L1F10	Ø10mm	L1F30	Ø30mm
L1F12	Ø12mm	L1F35	Ø35mm
L1F14	Ø14mm	L1F40	Ø40mm
L1F15	Ø15mm	L1F45	Ø45mm
L1F16	Ø16mm	L1F50	Ø50mm
L1F18	Ø18mm	L1F55	Ø55mm
L1F20	Ø20mm	L1F60	Ø60mm
L1F25	Ø25mm	L1F70	Ø70mm

JAZ®

### Συρματόβουρτσα πόλων μπαταρίας



Κωδικός  
MPB1000

JAZ®

### Σετ λίμες

Στρόγγυλη, τρίγωνη, τετράγωνη, ημιστρόγγυλη, πλατιά, μαχαιρωτή



Κωδικός  
59119



### Μίνι λίμες σετ

Πλατιά, τετράγωνη, τρίγωνη, ημιστρόγγυλη, στρόγγυλη



Κωδικός Τύπος  
5335-005 5 τεμαχίων

**TopMan**

### Σπειρολίμα σε χλιοστά



Κωδικός  
66901



### Σπειρολίμα σε ίντσες



Κωδικός  
66902



### Λαβές λίμας



Κωδικός  
26-317008-0  
26-317010-0  
26-317012-0

### Γυαλιά ηλεκτροκόλλησης 90X110

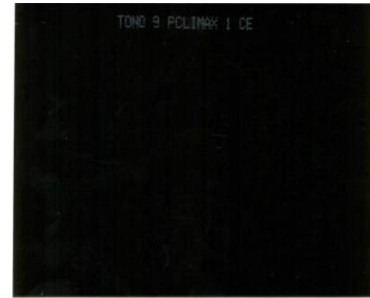

Κωδικός Τύπος  
461013 DIN13



### Γυαλιά ηλεκτροκόλλησης 75x98

Σκούρα



Κωδικός Τύπος  
9TMVI009 DIN9  
9TMVI010 DIN10  
9TMVI011 DIN11



### Γυαλιά ηλεκτροκόλλησης 75x98

Διαφανή



Κωδικός  
9TMVT000





### Βύσματα καλωδίων ηλεκτροκόλλησης

Αρσενικά



Κωδικός	60%	35%	Τύπος
9TCC-10-25-P	200A	250A	25mm <sup>2</sup>
9TCC-35-50-P	300A	400A	50mm <sup>2</sup>



### Βύσματα καλωδίων ηλεκτροκόλλησης

Θηλυκά για σασί



Κωδικός	60%	35%	Τύπος
9TCC-10-25-PS	200A	250A	25mm <sup>2</sup>
9TCC-35-50-PS	300A	400A	50mm <sup>2</sup>



### Τσιμπίδα γείωσης ηλεκτροκόλλησης

400A



Κωδικός  
88559



### Τσιμπίδα γείωσης ηλεκτροκόλλησης

400A



Κωδικός	60%	35%	Τύπος
9TEC200NT	200A	250A	35mm <sup>2</sup>
9TEC350NT	300A	400A	50mm <sup>2</sup>



### Τσιμπίδες ηλεκτροκόλλησης



Κωδικός	60%	35%	Τύπος	Τύπος
9TEH200FCL	150A	200A	25mm <sup>2</sup>	≤3,2mm
9TEH300FCL	200A	300A	35mm <sup>2</sup>	≤4mm



### Μάσκα ηλεκτροσυγκόλλησης



Κωδικός  
9TMM10



### Μάσκα ηλεκτροσυγκόλλησης



Κωδικός  
9TMM40



### Ηλεκτρόδια κοινά **NEO**

#### FINCORD-M E6013



Κωδικός	Τύπος	Συσκευασία
502201	2,00mm	3,5kg
502202	2,50mm	4kg
502203	3,25mm	4kg

\*το κιλό



### Ηλεκτρόδια ουρανού **NEO**

#### REX E6012



Κωδικός	Τύπος	Συσκευασία
502228	2,50mm	4kg
502229	3,25mm	4kg

\*το κιλό



### Ηλεκτρόδια βασικά **NEO**

#### SUPERCITO E7018



Κωδικός	Τύπος	Συσκευασία
502249	2,50mm	4,5kg
502250	3,25mm	4,5kg

\*το κιλό



### Ηλεκτρόδια σκληρά για γεμίσματα **NEO**

#### CITODUR-600A

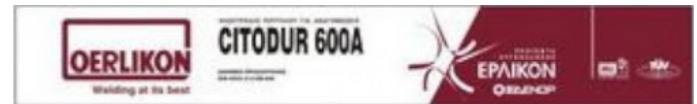

Κωδικός	Τύπος	Συσκευασία
502313	3,25mm	5,5kg
502314	4,00mm	5,5kg

\*το κιλό



### Ηλεκτρόδια για ανοξείδωτα **NEO**

#### BELINOX



Κωδικός	Τύπος	Συσκευασία
502370	E308 L-16 2,50mm	INOX308 3kg
502375	E316 L-16 2,50mm	INOX316 3kg

\*το κιλό



### Ηλεκτρόδια για χυτοσίδηρο **NEO**

#### CITOFONTE MONEL E6013



Κωδικός	Τύπος	Συσκευασία
502378	2,50mm	4kg
502379	3,00mm	4kg

\*το κιλό



### Σύρμα ηλεκτροκόλλησης **NEO**

#### PLW

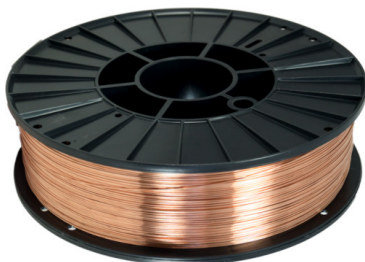

Κωδικός	Τύπος	Συσκευασία
508110	0,8mm	15kg
510840	1,0mm	15kg

\*το κιλό

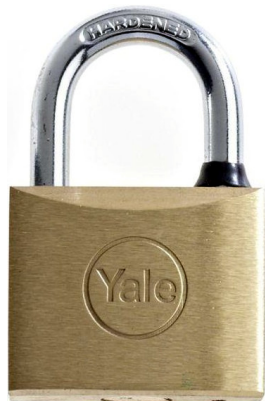

**Λουκέτα ορειχάλκινα****Κωδικός Τύπος**

Y1100025080X	25mm
Y1100030080X	30mm
Y1100040080X	40mm
Y1100050080X	50mm
Y1100060080X	60mm
Y1100070080X	70mm

**Λουκέτα ορειχάλκινα μακρύλαιμα****Κωδικός Τύπος**

Y1130025080X	25mm
Y1130030080X	30mm
Y1130040080X	40mm
Y1130050080X	50mm
Y1130060080X	60mm

**Λουκέτα INOX****Κωδικός Τύπος**

1140030	30mm
1140040	40mm
1140050	50mm

**Λουκέτα μακρύλαιμα INOX****Κωδικός Τύπος**

1150030	30mm
1150040	40mm
1150050	50mm

**Λουκέτα τάκου χαλύβδινα****Κωδικός Τύπος**

1640185	85mm
---------	------

**Λουκέτα τάκου ορειχάλκινα****Κωδικός Τύπος**

FFL8370000	75mm
FFL8390000	93mm

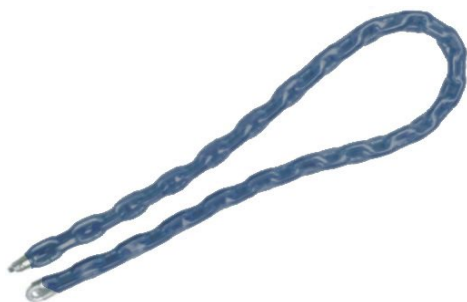
**Αλυσίδα ασφαλείας μηχανής****Κωδικός Τύπος**

FFCHA81200	8x1200mm
FFCHA81500	8x1500mm

**Λουκέτο πέταλο****Κωδικός Τύπος**

YUL1/12/20/1	Ø12X195mm
--------------	-----------



**Κλειδαριά γλώσσα σκέτη****Κωδικός Τύπος**

FFA1720200	20mm
FFA1725200	25mm
FFA1730200	30mm
FFA1735200	35mm
FFI1540110	40mm

**Κλειδαριά γλώσσα με κύλινδρο 3 κλειδιά****Κωδικός Τύπος**

FFLOC20C	20mm
FFLOC30C	30mm
FFLOC45C	45mm

**Κλειδαριά μπίλια με κύλινδρο 3 κλειδιά****Κωδικός Τύπος**

FFLOCBAL20C	20mm
FFLOCBAL25C	25mm
FFLOCBAL30C	30mm
FFLOCBAL35C	35mm
FFLOCBAL45C	45mm

**Κλειδαριά κουτιαστή****Κωδικός Τύπος**

FFP2450100-R	Δεξιά
FFP2450100-L	Αριστερή

**Κύλινδροι ασφαλείας****Κωδικός Τύπος**

FFSY61	N61 28/32
FFSY70	N70 34/34
FFSY71	N71 30/40
FFSY81	N70 30/50
FFSY82	N70 40/40

**Κύλινδροι ασφαλείας****Κωδικός Τύπος**

FFSY326378	30,5/30,5
FFSY327278	30,5/40,5
FFSY328278	30,5/50,5
FFSY328378	40,5/40,5
FFSY350378	40,5/60,5





### Κύλινδροι



Κωδικός	Τύπος
0134000	70mm
0135000	80mm έκκεντροι



### Κύλινδροι νίκελ



Κωδικός	Τύπος
HN30V40	30-40mm
HN30V50	30-50mm
HN40V50	40-50mm
HN40V60	40-60mm
HN27V27	58mm
HN30V30	60mm
HN35V35	70mm
HN40V40	80mm



### Κύλινδροι



Κωδικός	Τύπος
FFC1063180	30,5-30,5mm
FFC1072180	30,5-40,5mm
FFC1082180	30,5-50,5mm
FFC1083180	40,5-40,5mm
FFC1003180	40,5-60,5mm



### Κύλινδροι κοινού κλειδιού



Κωδικός	Τύπος
0122700	54mm
0133000	60mm



### Κυπριά πόρτας



Κωδικός	Τύπος
F16219P/1F	250mm



### Σούστα πόρτας

DC110



Κωδικός
0111003



### Σούστα πόρτας BT 110kg

DC310



Κωδικός
0121025



## Σφυριά πένας



Κωδικός	Τύπος
10361	300gr
10381	500gr
10401	800gr

**Kapriol®**

## Σφυριά ξυλουργού Evolution



Κωδικός	Τύπος
10100	Evo 9.0 300gr
10102	Evolution 300gr

**Kapriol®**

## Βαριοπούλες με ξύλινη λαβή



Κωδικός	Τύπος
10130	800gr
10140	1000gr
10150	1200gr
10160	1500gr
10170	2000gr

**Kapriol®**

## Βαριοπούλες με λαβή fiber



Κωδικός	Τύπος
10133	800gr
10143	1000gr
10153	1200gr
10163	1500gr

**Kapriol®**

## Ματσακόνι



Κωδικός
495000



## Ματσόλες



Κωδικός	Τύπος
1264027	23-137027-0 27mm
1264032	23-137032-0 32mm
1264035	23-137035-0 35mm
1264040	23-137040-0 40mm
1264060	23-137060-0 60mm
1264050	Ανταλλακτικά 50mm



## Ματσόλες



Κωδικός	Τύπος
10180	300gr
10181	500gr

**Kapriol®**

## Ματσόλες

Σκληρότητα: 80±5 Shore A



Κωδικός	Τύπος
B5GK50	Μπλε Ø48 - 500gr
B5GK51	Λευκή Ø48 - 500gr
B5GK100	Μπλε Ø59 - 1000gr
B5GK101	Λευκή Ø59 - 1000gr

**Ιταλίας**

**Σκύλες εξάγωνες 18mm**

Κωδικός	Τύπος
20412	60cm
20414	80cm
20415	1m

**Kapriol®****Σκύλες από ανθρακούχο ατσάλι 30X17mm**  
Οβάλ προφίλ

Κωδικός	Τύπος
20396	60cm
20397	80cm
20398	1m

**Kapriol®****Κοπίδια**

Κωδικός	Τύπος	Πάχος
20020	200mm	10mm
20030	250mm	10mm
20050	250mm	16mm

**Kapriol®****Κοπίδια**

Κωδικός	Τύπος
3101000/1	100mm
3101500/1	150mm
3102000/1	200mm
3102500/1	250mm
3103000/1	300mm

**RENNSTEIG****Κοπίδια φαρδιά**

Κωδικός	Τύπος
3850501	250X50mm
3850601	250X60mm
3850701	250X70mm

**RENNSTEIG****Κοπίδια λεπτά**

Κωδικός	Τύπος
3802400/1	240mm

**RENNSTEIG****Κοπίδια ηλεκτρολόγων**

Κωδικός	Τύπος
3602021	200mm
3602521	250mm

**RENNSTEIG****Βελόνια**

Κωδικός	Τύπος
3302000/1*	200mm
3302500/1*	250mm
3303000/1*	300mm

**RENNSTEIG****Βελόνια**

Κωδικός	Τύπος
20150	250mm

**Kapriol®**

Φτυάρι λάσπης τύπου Γαλλίας

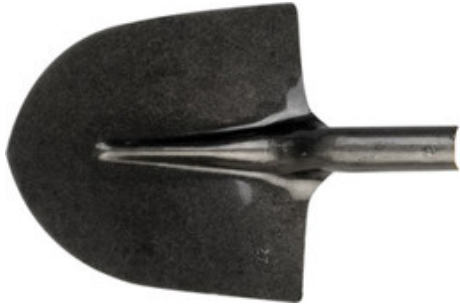

Κωδικός  
20934

**Kapriol®**

Πατόφτυαρο



Κωδικός  
20941

**Kapriol®**

Μακαράδες



Κωδικός	Τύπος
25150	145mm
25170	180mm

**Kapriol®**

Κουβάς πλαστικός



Κωδικός	Τύπος
25221	Ø36cm

**Kapriol®**

Κουβάς λάσπης



Κωδικός	Τύπος
25234	40l

**Kapriol®**

Κουβάς λάσπης



Κωδικός	Τύπος
57015	50l

**Kapriol®**



### Πιστόλι σιλικόνης



Κωδικός  
25244

**Kapriol®**

### Πιστόλι σιλικόνης βαρέως τύπου



Κωδικός  
25246

**Kapriol®**

### Πιστόλι αφρού πολυουρεθάνης



Κωδικός  
25261

**Kapriol®**

### Τσουβαλοδέτες



Κωδικός  
253031



### Σκαπανοτσέκουρα



Κωδικός Τύπος  
10790 400gr

**Kapriol®**

### Κασμαδάκι **NEO**



Κωδικός Τύπος  
10820 400gr

**Kapriol®**

### Τσεκουράκια



Κωδικός Τύπος  
11031 600gr

**Kapriol®**

### Τσεκούρια



Κωδικός Τύπος  
50265 1600gr

**Kapriol®**

## Αλουμινένιο πεντάλ ανύψωσης



Κωδικός  
25637

**Kapriol®**

## Χειρολαβή μεταφοράς γυψοσανίδων



Κωδικός  
25639

**Kapriol®**

## Πρίονι γυψοσανίδας



Κωδικός  
50133

**Kapriol®**

## Ράσα χούφτας



Κωδικός Τύπος  
25662 40X140

**Kapriol®**

## Ράσα γυψοσανίδας



Κωδικός Τύπος  
25659 40X250

**Kapriol®**

## Ανταλλακτική λεπίδα ράσας



Κωδικός Τύπος  
25661 40X250

**Kapriol®**

## Πρέσα γυψοσανίδων



Κωδικός  
25655

**Kapriol®**

## Πρέσα γυψοσανίδων



Κωδικός  
25656

**Kapriol®**

**Τηλεσκοπικός βραχίονας κάθετης στήριξης  
γυψοσανίδας**

Κλίση  $\leq 45^\circ$ . Βάρος έως 350 κιλά, ανάλογα το μήκος τοποθέτησης.

\*Σε κλίση  $45^\circ$ , μέγιστο βάρος 40kg.



Κωδικός	Τύπος	Βάρος	Τιμή
STE250	1,45-2,50m	200-350kg	63,00
STE300	1,70-3,00m	130-350kg	69,00
STE370	2,07-3,70m	75-350kg	73,60

**Σπάτουλα κόλλας πλακιδίων με δόντια**

Κωδικός	Δόντια
23020	8X8
23022	10X10

**Kapriol®****Σπάτουλα πλακιδίων με δόντια**

Κωδικός	Δόντια
23192	1,63X3

**Kapriol®****Σπάτουλα πλακιδίων με δόντια**

Κωδικός	Δόντια
23188	5X5
23187	10X10

**Kapriol®****Σπάτουλες φαρδιές με ξύλινη λαβή**

Κωδικός	Τύπος
23221	10cm
23218	12cm
23222	14cm
23219	16cm
23223	18cm
23220	20cm

**Kapriol®****Στοκαδόροι με ξύλινη λαβή**

Κωδικός	Τύπος
23131	30mm
23141	40mm
23151	50mm
23161	60mm
23171	70mm
23181	80mm

**Kapriol®****Στοκαδόροι INOX**

Κωδικός	Τύπος
23143	40mm
23163	60mm
23183	80mm
23203	100mm

**Kapriol®**

**Ξύστρα**

**Κωδικός**  
23180

**Kapriol®**

**Ξύστρα πολυχρηστική 6 σε 1**

**Κωδικός**  
23147

**Kapriol®**

**Ξύστρα κονταριού 100mm**

Λάμα από ανθρακούχο ατσάλι



**Κωδικός**  
23318

**Kapriol®**

**Ξύστρα με ξυράφια 200mm**

SCL-200BC  
Περιέχει 5 λάμες



**Κωδικός**  
525538

**KDS®**

**Μαγνητικό αλφάδι τσέπης** **NEO**

Υψηλής ευκρίνειας



Κωδικός	Τύπος
GO!	75mm

**Μαγνητικό αλφάδι τσέπης πλαστικό** **NEO**

3 μάτια



Κωδικός	Τύπος
PTM-520	200mm

**Αλφάδια αλουμινίου** **NEO**

3 μάτια



Κωδικός	Τύπος
I5-30	30cm
I5-40	40cm
I5-50	50cm
I5-60	60cm
I5-80	80cm
I5-100	100cm
I5-120	120cm

**Αλφάδια αλουμινίου βαρέως τύπου** **NEO**

2 μάτια



Κωδικός	Τύπος
AZ-40	40cm
AZ-50	50cm
AZ-60	60cm
AZ-80	80cm
AZ-100	100cm
AZ-120	120cm
AZ-150	150cm
AZ-180	180cm
AZ-200	200cm

**Αλφάδια αλουμινίου μαγνητικά βαρέως τύπου** **NEO**

2 μάτια



Κωδικός	Τύπος
AZM-30	30cm
AZM-40	40cm
AZM-50	50cm
AZM-60	60cm
AZM-80	80cm
AZM-100	100cm



**Γρασαδοράκια ίσια****Τύπος**

6X1  
8X1  
8X1,25  
10X1  
10X1,5  
1/8" GAS  
1/4" GAS

**Γρασαδοράκια 45°****Τύπος**

6X1  
8X1  
10X1  
10X1,5  
1/8" GAS  
1/4" GAS  
1/4"  
5/16"

**Γρασαδοράκια 90°****Τύπος**

6X1  
8X1  
8X1,25  
10X1  
10X1,5  
1/8" GAS  
1/4" GAS  
1/4"  
5/16"

**Γρασαδοράκια ίσια INOX****Τύπος**

6X1  
8X1  
10X1  
1/8" GAS  
1/4" GAS  
1/4"  
5/16"

**Γρασαδοράκια 45° INOX****Τύπος**

6X1  
8X1  
10X1  
1/8" GAS  
1/4" GAS  
1/4"

**Γρασαδοράκια 90° INOX****Τύπος**

6X1  
8X1  
10X1  
1/8" GAS  
1/4" GAS  
1/4"

**Γρασαδοράκια συρταρωτά****Τύπος**

1/4" GAS  
3/8" GAS

**Γρασαδοράκια συρταρωτά****Κωδικός Πάσο Τύπος**

1001701	1/8"	5/8"
1001700	1/4"	5/8"
10002202	1/4"	7/8"
10002201	3/8"	7/8"

**Γρασαδοράκια τσοκ συρταρωτά****Τύπος**

5/8"  
7/8"

**Εύκαμπτες προεκτάσεις γρασαδόρου 1/8"****Τύπος**

280mm  
480mm

**Γρασαδόρος χειρός - αέρος σειτ****Κωδικός Τύπος**

88701L 500cc

**FORCE**



### Χειροκίνητη τρόμπα λαδιού **NEO**

Για λάδια έως SAE 50  
Κατάλληλη για βαρέλια  
60/200/220 l



**Κωδικός** Τύπος  
12020 2" 12l/min

**PRESSOL**

### Γρασαδόρος χειρός G 1/8" **NEO**



**Κωδικός** Τύπος  
12632 125 500cm<sup>3</sup>

**PRESSOL**

### Γρασαδόρος χειρός μίνι G 1/8" **NEO**

Λειτουργεί με ένα χέρι



**Κωδικός** Τύπος  
12276 125cm<sup>3</sup>

**PRESSOL**

### Γρασαδόρος πατητός **NEO**



**Κωδικός** Τύπος  
12332 150ml

**PRESSOL**

### Τσοκ γρασαδόρου **NEO**

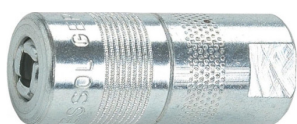

**Κωδικός** Τύπος  
12731 SW 13mm Ø15mm G1/8"

**PRESSOL**

### Λαδικά χειρός **NEO**

1ml ανά πάτημα



Κωδικός	Τύπος
05121	125 ml
05122	175 ml
05133	250 ml
05134	350 ml
05135	500 ml
05226	750 ml

**PRESSOL**

### Λάδι - Γράσο **NEO**

Γενικής χρήσης



**Κωδικός** Τύπος  
10097 Λάδι 100ml  
10564 Γράσο 80γρ

**PRESSOL**



## Σφήνες ίσιες



Τύπος	Τύπος	Τύπος	Τύπος	Τύπος
4X4X16mm	6X6X80mm	10X8X80mm	14X9X100mm	20X12X50mm
4X4X20mm	6X6X90mm	10X8X90mm	14X9X110mm	20X12X60mm
4X4X25mm	6X6X100mm	10X8X100mm	14X9X125mm	20X12X70mm
4X4X30mm	8X7X20mm	10X8X110mm	14X9X140mm	20X12X80mm
4X4X36mm	8X7X25mm	10X8X125mm	16X10X40mm	20X12X90mm
4X4X40mm	8X7X30mm	12X8X30mm	16X10X45mm	20X12X100mm
5X5X16mm	8X7X36mm	12X8X36mm	16X10X50mm	20X12X110mm
5X5X20mm	8X7X40mm	12X8X40mm	16X10X60mm	20X12X120mm
5X5X25mm	8X7X45mm	12X8X45mm	16X10X70mm	20X12X130mm
5X5X30mm	8X7X50mm	12X8X50mm	16X10X80mm	20X12X140mm
5X5X36mm	8X7X60mm	12X8X60mm	16X10X90mm	22X14X60mm
5X5X40mm	8X7X70mm	12X8X70mm	16X10X100mm	22X14X70mm
5X5X45mm	8X7X80mm	12X8X80mm	16X10X125mm	22X14X80mm
5X5X50mm	8X7X90mm	12X8X90mm	18X11X40mm	22X14X90mm
5X5X60mm	8X7X100mm	12X8X100mm	18X11X50mm	22X14X100mm
6X6X16mm	8X7X110mm	12X8X125mm	18X11X60mm	22X14X125mm
6X6X20mm	8X7X125mm	14X9X30mm	18X11X70mm	22X14X140mm
6X6X25mm	8X7X140mm	14X9X36mm	18X11X80mm	22X14X150mm
6X6X30mm	10X8X30mm	14X9X40mm	18X11X90mm	25X14X70mm
6X6X36mm	10X8X36mm	14X9X45mm	18X11X100mm	25X14X80mm
6X6X40mm	10X8X40mm	14X9X50mm	18X11X110mm	25X14X90mm
6X6X45mm	10X8X45mm	14X9X60mm	18X11X120mm	25X14X100mm
6X6X50mm	10X8X50mm	14X9X70mm	18X11X130mm	25X14X120mm
6X6X60mm	10X8X60mm	14X9X80mm	18X11X140mm	25X14X140mm
6X6X70mm	10X8X70mm	14X9X90mm	18X11X150mm	28X16X125mm

## Σφήνες ίσιες 1 μέτρου

Τύπος	Τύπος
5X5mm	14X9mm
6X6mm	16X10mm
8X7mm	18X11mm
10X8mm	20X12mm
12X8mm	



## Σφήνες μισοφέγγαρες

Τύπος	Τύπος	Τύπος
3X5mm	5X9mm	10X13mm
3X6,5mm	6X7,5mm	10X16mm
4X5mm	6X9mm	
4X6,5mm	6X11mm	
4X7,5mm	8X11mm	
5X6,5mm	8X13mm	
5X7,5mm	10X11mm	



## Ντίξες τραπεζοειδείς 1m

Κωδικός	Πάσο	Κωδικός	Πάσο
103C1510	10x3	103C1530	30x6
103C1512	12x3	103C1532	32x6
103C1514	14x3	103C1536	36x6
103C1516	16x4	103C1540	40x7
103C1518	18x4	<b>Μολυβδούχος χάλυβας C15</b>	
103C1520	20x4	<b>Μήκος: 1 μέτρο</b>	
103C1522	22x5		
103C1524	24x5		
103C1526	26x5		
103C1528	28x5		



Made in EU

## Τραπεζοειδή παξιμάδια

Κωδικός	Πάσο	Κωδικός	Πάσο
D22L15	10x3mm	D60L45	30x6mm
D26L18	12x3mm	D60L48	32x6mm
D30L21	14x3mm	D75L54	36x6mm
D36L24	16x4mm	D80L60	40x7mm
D40L27	18x4mm	<b>Μολυβδούχος χάλυβας C15</b>	
D45L30	20x4mm	<b>D: Διάμετρος L: Μήκος</b>	
D45L33	22x5mm		
D50L36	24x5mm		
D50L39	26x5mm		
D60L42	28x5mm		



Made in EU

**Πόμολα μαργαρίτα με αρσενικό πάσο**

Βακελίτης με αντοχή σε διαλύτες, λάδια, γράσα και χημικά PF. 7 λοβοί.

Κωδικός	Τύπος	Πάσο	Κωδικός	Τύπος	Πάσο
B1V7M200520	20mm	M5X20mm	B1V7M400850	40mm	M8X50mm
B1V7M200620	20mm	M6X20mm	B1V7M401030	40mm	M10X30mm
B1V7M300620	30mm	M6X20mm	B1V7M500820	50mm	M8X20mm
B1V7M300630	30mm	M6X30mm	B1V7M500830	50mm	M8X30mm
B1V7M300815	30mm	M8X15mm	B1V7M500840	50mm	M8X40mm
B1V7M300825	30mm	M8X25mm	B1V7M501040	50mm	M10X40mm
B1V7M400630	40mm	M6X30mm	B1V7M600840	60mm	M8X40mm
B1V7M400640	40mm	M6X40mm	B1V7M601030	60mm	M10X30mm
B1V7M400820	40mm	M8X20mm	B1V7M601050	60mm	M10X50mm
B1V7M400830	40mm	M8X30mm	B1V7M601240	60mm	M12X40mm
B1V7M400840	40mm	M8X40mm	B1V7M601250	60mm	M12X50mm

**Ιταλίας****Πόμολα μαργαρίτα με αρσ. πάσο INOX AISI 304**

Βακελίτης με αντοχή σε διαλύτες, λάδια, γράσα και χημικά PF. 7 λοβοί.

Κωδικός	Τύπος	Πάσο
B1V7MX300430	30mm	M4X30mm
B1V7MX300620	30mm	M6X20mm
B1V7MX400630	40mm	M6X30mm
B1V7MX401030	40mm	M10X30mm
B1V7MX501040	50mm	M10X40mm

**Ιταλίας****Πόμολα μαργαρίτα από PF Duroplast με αρσενικό πάσο**

Ανθεκτικά σε έλαια, λίπη, καύσιμα και διαλύτες. 6 λοβοί.

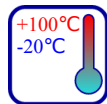

Κωδικός	Τύπος	Πάσο
01PF2B20	PF2 M5X20	20mm M5X20mm
01PF2B30	PF2 M5X30	20mm M5X30mm
01PF3P25	PF3 M8X25	30mm M8X25mm
01PF4C25	PF4 M6X25	40mm M6X25mm
01PF4C40	PF4 M6X40	40mm M6X40mm
01PF4D20	PF4 M8X20	40mm M8X20mm
01PF4D40	PF4 M8X40	40mm M8X40mm
01PF6F45	PF6 M12X45	45mm M12X45mm
01PF5D20	PF4 M8X20	50mm M8X20mm
01PF5D35	PF5 M8X35	50mm M8X35mm
01PF6E50	PF6 M10X50	50mm M10X40mm
01PF6D25	PF6 M8X25	60mm M8X25mm
01PF6D40	PF6 M8X40	60mm M8X40mm
01PF6E30	PF6 M10X30	60mm M10X30mm
01PF6E70	PF6 M10X70	60mm M10X70mm

**Ιταλίας****Πόμολα μαργαρίτα από PF Duroplast με αρσενικό πάσο INOX**

Ανθεκτικά σε έλαια, λίπη, καύσιμα και διαλύτες. 6 λοβοί.

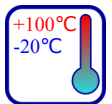

Κωδικός	Τύπος	Πάσο
01PF2B20X	PF2 M5X20	20mm M5X20mm
01PF2B30X	PF2 M5X30	20mm M5X30mm
01PF2B40X	PF2 M5X40	20mm M5X40mm
01PF2C20X	PF2 M6X20	20mm M6X20mm
01PF2C30X	PF2 M6X30	20mm M6X30mm
01PF2C40X	PF2 M6X40	20mm M6X40mm
01PF3D15X	PF3 M8X15	30mm M8X15mm
01PF3D25X	PF3 M8X25	30mm M8X25mm
01PF4C25X	PF4 M6X25	40mm M6X25mm

**Ιταλίας**

### Λεβιέδες καστάνιας από πολυαμίδιο με αρσενικό πάσο

Ανθεκτικά σε έλαια, λίπη, καύσιμα και διαλύτες.

Κωδικός	Τύπος	Πάσο
0155C15	KP-P55 M6X15	55mm M6X15mm
0155C30	KP-P55 M6X30	55mm M6X30mm
0155D15	KP-P55 M8X15	55mm M8X15mm
0155D30	KP-P55 M8X30	55mm M8X30mm
0179D20	KP-P79 M8X20	80mm M8X20mm
0179D30	KP-P79 M8X30	80mm M8X30mm
0179D40	KP-P79 M8X40	80mm M8X40mm
0179E25	KP-P79 M10X25	80mm M10X25mm
0179E35	KP-P79 M10X35	80mm M10X35mm
0179E50	KP-P79 M10X50	80mm M10X50mm
0179F25	KP-P79 M12X25	80mm M12X25mm
0179F40	KP-P79 M12X40	80mm M12X40mm
0179F50	KP-P79 M12X50	80mm M12X50mm

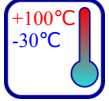

Ιταλίας

### Πόμολα μαργαρίτα από PF Duroplast με θηλυκό πάσο

Ανθεκτικά σε έλαια, λίπη, καύσιμα και διαλύτες. 6 λοβοί.



Κωδικός	Διάμετρος	Πάσο
01PB2A	PB2 M4 20mm	M4
01PB2B	PB2 M5 20mm	M5
01PB2C	PB2 M6 20mm	M6
01PB3B	PB3 M5 30mm	M5
01PB4F	PB4 M12 40mm	M12
01PB6F	PB6 M12 60mm	M12
01PB7E	PB7 M10 70mm	M10
01PB7F	PB7 M12 70mm	M12
01PB7N	PB7 M14 70mm	M14

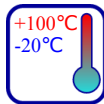

Ιταλίας

### Πόμολα μαργαρίτα από PF Duroplast με διαμπερές πάσο

Ανθεκτικά σε έλαια, λίπη, καύσιμα και διαλύτες.



Με 6 λοβούς			
Κωδικός	Τύπος	Πάσο	
01PP5D	PP5 M8	50mm	M8
01PP5E	PP5 M10	50mm	M10
01PP5F	PP5 M12	50mm	M12

Με 7 λοβούς			
Κωδικός	Τύπος	Πάσο	
B1V7BP3004	30mm	M4	
B1V7BP3005	30mm	M5	
B1V7BP4006	40mm	M6	
B1V7BP5008	50mm	M8	
B1V7BP5010	50mm	M10	
B1V7BP5012	50mm	M12	

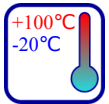

Ιταλίας

### Πόμολα μαργαρίτα με θηλυκό πάσο

Βακελίτης με αντοχή σε διαλύτες, λάδια, γράσα και χημικά PF. 7 λοβοί.

Κωδικός	Τύπος	Πάσο
B1V7B3006	30mm	M6
B1V7B3008	30mm	M8
B1V7B4006	40mm	M6
B1V7B4008	40mm	M8
B1V7B4010	40mm	M10
B1V7B5008	50mm	M8
B1V7B5010	50mm	M10
B1V7B6010	60mm	M10
B1V7B7010	70mm	M10
B1V7B7012	70mm	M12
B1V7B7014	70mm	M14

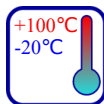

Ιταλίας

### Λεβιέδες καστάνιας από πολυαμίδιο με θηλυκό πάσο

Ανθεκτικά σε έλαια, λίπη, καύσιμα και διαλύτες.



Κωδικός	Τύπος	Πάσο
0155C	KP-B55 M6	55mm M6
0155D	KP-B55 M8	55mm M8
0179D	KP-B79 M8	80mm M8
0179E	KP-B79 M10	80mm M10
0179F	KP-B79 M120	80mm M12

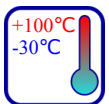

Ιταλίας

**Βολάν σκέτα με 4 ακτίνες**

Με μασίφ κορμό

**Κωδικός Διάμετρος**

B1VL100	100mm
B1VL120	120mm
B1VL140	140mm
B1VL160	160mm
B1VL200	200mm

**Ιταλίας****Βολάν με υπομόγλιο και 4 ακτίνες**

Με μασίφ κορμό

**Κωδικός Διάμετρος**

B1VLG100	100mm
B1VLG120	120mm
B1VLG140	140mm
B1VLG160	160mm
B1VLG200	200mm

**Ιταλίας****Χειρολαβές πόρτας νάιλον τύπου Π**

Αντοχή σε διαλύτες, λάδια και γράσα

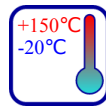
**Ιταλίας****Κωδικός Μήκος Τρύπες**

B1MPP10711	107mm	93,5±0,5mm
B1MPP13614	136mm	117±0,5mm
B1MPP15114	151mm	132±0,5mm
B1MPP19714	197mm	179±0,5mm

**Μεντεσέδες νάιλον (πολυαμίδιο)****Ιταλίας****Κωδικός Τύπος Τρύπες**

A3CC40	40X38,5mm	25mm
A3CC48	49,5X47mm	30mm
A3CC65	65X64,3mm	40mm
A3CC98	98X96,5mm	60mm

**Μακρόστενες χειρολαβές βακελίτου**

Θηλυκό πάσο

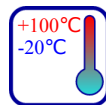
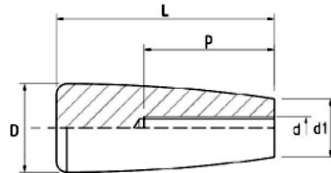
**Ιταλίας**

Κωδικός	D	d	L	d1	P
B1MO6406	26mm	M6	64mm	17mm	35mm
B1MO6408	26mm	M8	64mm	17mm	26mm
B1MO6410	26mm	M10	64mm	17mm	29mm
B1MO8408	33mm	M8	84mm	21mm	45mm
B1MO8410	33mm	M10	84mm	21mm	45mm
B1MO8412	33mm	M12	84mm	21mm	45mm

**Σφαιρικά πόμολα από πολυαμίδιο με θηλυκό πάσο**

Ανθεκτικά σε έλαια, λίπη, καύσιμα και διαλύτες.

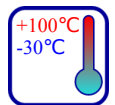
**Ιταλίας**

Κωδικός	Τύπος	Πάσο
01SSF25C	SSFD.25 M6	25mm M6
01SSF25D	SSFD.25 M8	25mm M8
01SSF35D	SSFD.35 M8	35mm M8
01SSF40D	SSFD.40 M8	40mm M8
01SSF45D	SSFD.45 M8	45mm M8
01SSF40E	SSFD.40 M10	40mm M10
01SSF45E	SSFD.45 M10	45mm M10
01SSF40F	SSFD.40 M12	40mm M12
01SSF45F	SSFD.45 M12	45mm M12

**Τάπες εξάγωνων περικόχλιων από πολυαιθυλένιο**

Ανθεκτικά σε έλαια, λίπη, καύσιμα και διαλύτες.

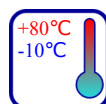
**Ιταλίας**

Κωδικός	Τύπος
01MB6	MB 6 M6
01MB8	MB 8 M8
01MB10	MB 10 M10
01MB12	MB 12 M12

## Πέλματα βάσεις Ø40-Ø60

Γαλβανιζέ

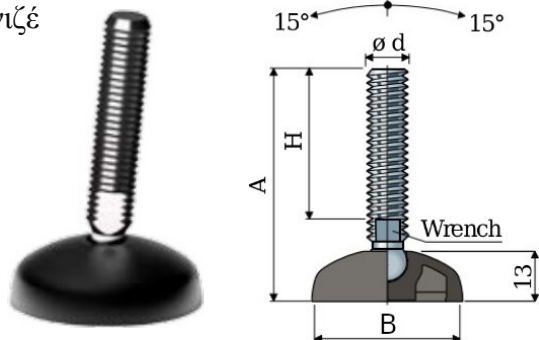

Κωδικός	B	Ø d	A	H	Αντοχή
10/7392	Ø40	M8	88mm	65mm	≤10000N
10/7002	Ø40	M10	95mm	70mm	≤11000N
15/7020	Ø50	M10	95mm	70mm	≤12000N
15/7400	Ø50	M12	105mm	77mm	≤13000N
18/7406	Ø60	M12	109mm	77mm	≤14000N
18/7050	Ø60	M14	94mm	61mm	≤15000N
18/7054	Ø60	M16	95mm	60mm	≤17000N

Ιταλίας

## Πέλματα βάσεις Ø80-Ø124

Γαλβανιζέ

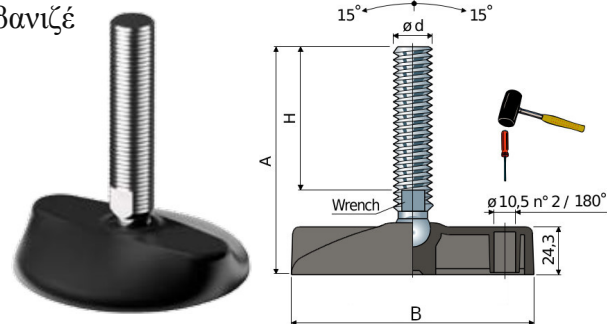

Κωδικός	B	Ø d	A	H	Αντοχή
25/7460	Ø80	M12	111mm	77mm	≤15000N
25/7084	Ø80	M14	96mm	61mm	≤16000N
25/7086	Ø80	M14	126mm	91mm	≤16000N
25/7462	Ø80	M16	127mm	90mm	≤19000N
38/7112	Ø102	M16	145mm	105mm	≤22000N
38/7118	Ø102	M20	130mm	86mm	≤24000N
45/7142	Ø124	M20	164mm	116mm	≤27000N
45/7148	Ø124	M24	170mm	122mm	≤29000N

Ιταλίας

## Πέλματα βάσεις σταθερές Ø30-Ø50

Γαλβανιζέ βίδα

Πόδι: Fiberglass reinforced nylon



Κωδικός	A	M	B	H	Αντοχή
A3E30/0630	Ø30	M6	30mm	13mm	≤150daN
A3E1	Ø32	M8	26mm	16mm	≤300daN
A3E4	Ø40	M10	33mm	16mm	≤400daN
A3E50/1030	Ø50	M10	30mm	16mm	≤150daN

Ιταλίας

## Αντιολισθητικά λάστιχα πελμάτων

NEW



Κωδικός	Τύπος
7263 [11852]	Ø40mm
7264 [11777]	Ø50mm
7265 [11778]	Ø60mm
7266 [11428]	Ø80mm
7267 [11779]	Ø100mm

Ιταλίας

## Πέλματα βάσεις Ø40-Ø60

INOX AISI 304

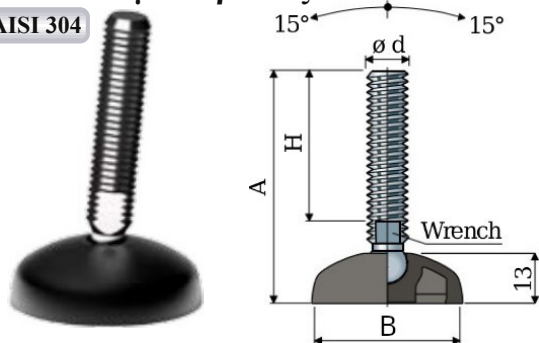

Κωδικός	B	Ø d	A	H	Αντοχή
10/7393	Ø40	M8	88mm	65mm	≤10000N
10/7003	Ø40	M10	95mm	70mm	≤11000N
15/7021	Ø50	M10	95mm	70mm	≤12000N
15/7401	Ø50	M12	105mm	77mm	≤13000N
18/7045	Ø60	M12	94mm	63mm	≤14000N
18/7051	Ø60	M14	94mm	61mm	≤15000N

Ιταλίας

## Πέλματα βάσεις Ø80-Ø124

INOX AISI 304

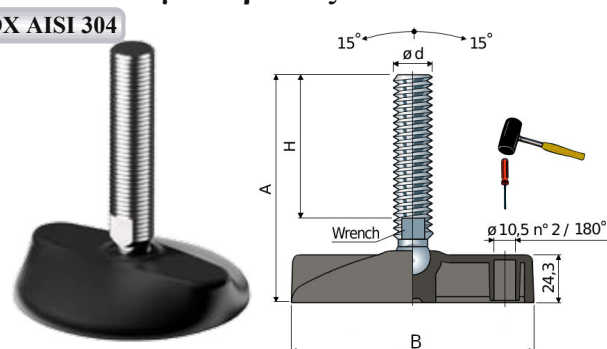

Κωδικός	B	Ø d	A	H	Αντοχή
25/7079	Ø80	M12	96mm	63mm	≤15000N
25/7087	Ø80	M14	126mm	91mm	≤16000N
25/7463	Ø80	M16	127mm	90mm	≤19000N
38/7113	Ø102	M16	145mm	105mm	≤22000N
38/7121	Ø102	M20	160mm	116mm	≤24000N

Ιταλίας



### Τάπες στρόγγυλες

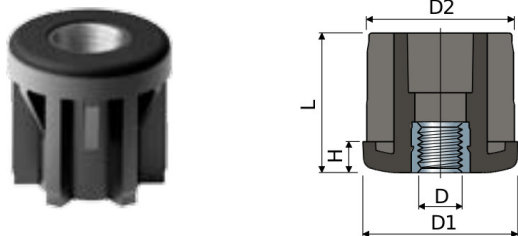

Κωδικός	D	D1	D2	H	L	Αντοχή
64/80858	M10	30	Ø27	6	31	≤5000N
64/7210	M10	38	Ø35	8	38	≤5000N
64/7214	M10	42,4	Ø39,4	8	38	≤7000N

Ιταλίας

### Τάπες τετράγωνες

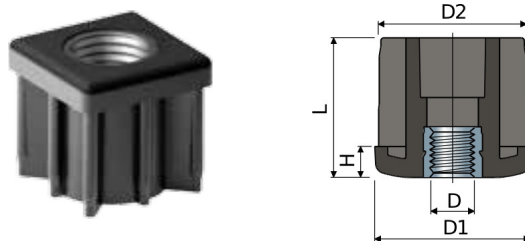

Κωδικός	D	D1	D2	H	L	Αντοχή
68/7232	M10	30	27	6	31	≤5000N
68/7236	M10	35	32	8	38	≤7000N
68/7241	M10	40	37	8	38	≤7500N
68/7244	M16	40	37	8	38	≤9000N

Ιταλίας

### Μαγνήτες νεοδιμίου 35N στρόγγυλοι



Κωδικός	Τύπος	Κωδικός	Τύπος
MANE82	Ø8X2	MANE205	Ø20X5
MANE102	Ø10X2	MANE256	Ø25X6
MANE103	Ø10X3	MANE305	Ø30X5
MANE122	Ø12X2	MANE306	Ø30X6
MANE123	Ø12X3	MANE405	Ø40X5
MANE153	Ø15X3	MANE7030	Ø70X30
MANE203	Ø20X3		

### Μαγνήτες νεοδιμίου 35N τετράγωνοι



Κωδικός	Τύπος
MANE10103	10X10X3
MANE12124	12X12X4
MANE15155	15X15X5
MANE20205	20X20X5
MANE25255	25X25X5
MANE30306	30X30X6

### Μαγνήτες νεοδιμίου 35N με τρύπα

Φρέζα τρύπας 90°



Κωδικός	Τύπος	Τρύπα	Λακτύλιος teflon
	Ø10X5mm	Ø3mm	✗
	Ø12X5mm	Ø3mm	✗
	Ø16X5mm	Ø3mm	✗
	Ø20X6mm	Ø4mm	✓
	Ø25X7mm	Ø5mm	✓

### Τρυπανόβιδες Wafer (truss)

Χάλυβας C1022

Διαστάσεις
4,2X13
4,2X16
4,2X19
4,2X25
4,2X32
4,2X38



### Τρυπανόβιδες με εξάγωνο κεφάλι

Χάλυβας C1022  
με ροδέλα και φλάντζα (EPDM)

Διαστάσεις
6,3X19
6,3X25
6,3X32
6,3X38
6,3X50
6,3X60
6,3X70
6,3X75
6,3X88
6,3X100



### Τρυπανόβιδες με εξάγωνο κεφάλι χωρίς ροδέλα

Χάλυβας C1022

Διαστάσεις	Διαστάσεις
6,3X19	6,3X80
6,3X25	6,3X88
6,3X32	6,3X100
6,3X38	6,3X110
6,3X50	6,3X125
6,3X60	6,3X140
6,3X75	6,3X150



**Σφυγκτήρες κολάρων με πλαστική πεταλούδα** **NEO**

Κωδικός	Τύπος
122-12309-012	Ø8-12mm
122-12309-016	Ø10-16mm
122-12309-022	Ø12-22mm

**whirlpower.**  
The Original.

**Βιδωτά κολάρα σφυγκτήρες γαλβανιζέ**

Κωδικός	Πάχος	Διάμετρος
W108-16/9	9mm	8-12mm
	9mm	8-16mm
W110-16/9	9mm	10-16mm
W112-22/9	9mm	12-22mm
W116-27/25	9mm	16-27mm
MEB920/32	9mm	20-32mm
MEB925/40	9mm	25-40mm
MEB932/50	9mm	35-50mm
W140-60/9	9mm	40-60mm
	9mm	50-70mm
	9mm	60-80mm
	9mm	70-90mm
	9mm	80-100mm
	9mm	90-110mm



**NORMA GROUP**

**Βιδωτά κολάρα σφυγκτήρες γαλβανιζέ**

Κωδικός	Πάχος	Διάμετρος
W116-27	12mm	16-27mm
W120-32	12mm	20-32mm
W125-40	12mm	25-40mm
W140-60	12mm	40-60mm
W135-50	12mm	35-50mm
W150-70	12mm	50-70mm
W160-80	12mm	60-80mm
W180-100	12mm	80-100mm
W170-90	12mm	70-90mm
W190-110	12mm	90-110mm
W1110-130	12mm	110-130mm
W1120-140	12mm	120-140mm
W1130-150	12mm	130-150mm
W1140-160	12mm	140-160mm
W1180-200	12mm	180-200mm
W1200-220	12mm	200-220mm
W1240-260	12mm	240-260mm
W1300-320	12mm	300-320mm



**NORMA GROUP**

**Βιδωτά κολάρα σφυγκτήρες γαλβανιζέ**

Κωδικός	Πάχος	Διάμετρος	Κωδικός	Πάχος	Διάμετρος
W123-25	18mm	23-25mm	W173-79	25mm	73-79mm
W125-27	18mm	25-27mm	W179-85	25mm	79-85mm
W127-29	18mm	27-29mm	W185-91	25mm	85-91mm
W129-31	18mm	29-31mm	W191-97	25mm	91-97mm
W131-34	18mm	31-34mm	W197-104	25mm	97-104mm
W134-37	18mm	34-37mm	W1104-112	25mm	104-112mm
W137-40	18mm	37-40mm	W1112-121	25mm	112-121mm
W140-43	18mm	40-43mm	W1121-130	25mm	121-130mm
W143-47	20mm	43-47mm	W1130-140	30mm	130-140mm
W147-51	20mm	47-51mm	W1140-150	30mm	130-140mm
W151-55	20mm	51-55mm	W1150-162	25mm	150-162mm
W155-59	20mm	55-59mm	W1162-174	30mm	162-174mm
W159-63	20mm	59-63mm	W1174-187	30mm	174-187mm
W163-68	20mm	63-68mm	W1187-200	30mm	187-200mm
W168-73	25mm	68-73mm			



**NORMA GROUP**

**Βιδωτά κολάρα σφυγκτήρες INOX W4**

Κωδικός	Πάχος	Διάμετρος
W27-11/5	5mm	7-11mm (Inox βέργα)
W408-16/9	9mm	8-16mm
W412-22/9	9mm	12-22mm
W416-27/9	9mm	16-27mm
W420-32/9	9mm	20-32mm
W425-40/9	9mm	25-40mm
W432-35/9	9mm	32-50mm

**Βιδωτά κολάρα σφυγκτήρες INOX W4**

Κωδικός	Πάχος	Διάμετρος
W416-27/12	12mm	16-27mm
W420-32/12	12mm	20-32mm
W425-40/12	12mm	25-40mm
W430-45/12	12mm	30-45mm
W435-50/12	12mm	35-50mm
W440-60/12	12mm	40-60mm
W450-70/12	12mm	50-70mm
W460-80/12	12mm	60-80mm
W470-90/12	12mm	70-90mm
W480-100/12	12mm	80-100mm
W490-110/12	12mm	90-110mm
W4100-120/12	12mm	100-120mm
W4110-130/12	12mm	110-130mm

**Βιδωτά κολάρα σφυγκτήρες INOX W4**

Κωδικός	Πάχος	Διάμετρος
	12mm	120-140mm
	12mm	130-150mm
	12mm	140-160mm
	12mm	160-180mm
	12mm	175-205mm
	12mm	200-220mm
	12mm	205-232mm
	12mm	220-240mm
	12mm	240-260mm

**Βιδωτά κολάρα σφυγκτήρες BT INOX W4**

Κωδικός	Πάχος	Διάμετρος
W423-25/18	18mm	23-25mm
W425-27/18	18mm	25-27mm
W427-29/18	18mm	27-29mm
W429-31/18	18mm	29-31mm
W431-34/18	18mm	31-34mm
W434-37/18	18mm	34-37mm
W437-40/18	18mm	37-40mm
W440-43/18	18mm	40-43mm

**Βιδωτά κολάρα σφυγκτήρες BT INOX W4**

Κωδικός	Πάχος	Διάμετρος
W443-47/20	20mm	43-47mm
W447-51/20	20mm	47-51mm
W451-55/20	20mm	51-55mm
W455-59/20	20mm	55-59mm
W459-63/20	20mm	59-63mm
W463-68/20	20mm	63-68mm

**Βιδωτά κολάρα σφυγκτήρες BT INOX W4**

Κωδικός	Πάχος	Διάμετρος
	25mm	68-73mm
W473-79/25	25mm	73-79mm
W479-85/25	25mm	79-85mm
W485-91/25	25mm	85-91mm
	25mm	91-97mm
W4104-112/25	25mm	104-112mm
W4112-121/25	25mm	112-121mm
W4121-130/25	25mm	121-130mm

**Βιδωτά κολάρα σφυγκτήρες ανοξείδωτα ρολλό 30 μέτρων**

INOX W4

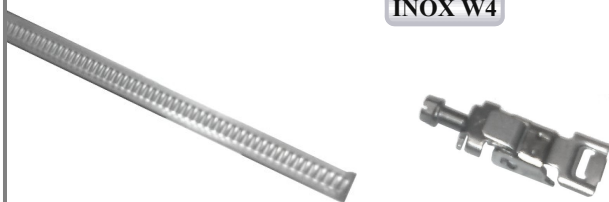

Κωδικός	Τύπος
W430M	Κολάρο ρολλό 30 μέτρων πλάτος 9mm
W4CD50	Κεφαλές σφυγκτήρα κολάρων (τεμάχιο)

**Κολάρα σφυγκτήρες INOX W2**

25 τεμάχια



Κωδικός	Τύπος
2AFI350	4,6x350mm



## Εξάγωνες βίδες DIN933 &amp; DIN931 σε μετρικό INOX A2

Πάχος→	4mm	5mm	6mm	8mm	10mm	12mm	14mm	16mm	18mm	20mm	24mm
Βήμα→	0,70	0,80	1,00	1,25	1,50	1,75	2,00	2,00	2,50	2,50	3,00
↓Μήκος↓											
8		✓									
10	✓	✓	✓	✓							
12	✓	✓	✓	✓							
16	✓	✓	✓	✓	✓						
20	✓	✓	✓	✓	✓	✓					
25	✓	✓	✓	✓	✓	✓	✓				
30	✓	✓	✓	✓	✓	✓	✓	✓	✓	✓	
35	✓	✓	✓	✓	✓	✓	✓	✓	✓	✓	
40	✓	✓	✓	✓	✓	✓	✓	✓	✓	✓	
45	✓	✓	✓	✓	✓	✓	✓	✓	✓	✓	
50	✓	✓	✓	✓	✓	✓	✓	✓	✓	✓	✓
55			✓	✓	✓	✓	✓				
60	✓	✓	✓	✓	✓	✓	✓	✓	✓	✓	✓
65				✓	✓	✓					
70		✓	✓	✓	✓	✓	✓	✓	✓	✓	✓
80			✓	✓	✓	✓	✓	✓	✓	✓	✓
90			✓	✓	✓	✓	✓	✓	✓	✓	✓
100			✓	✓	✓	✓	✓	✓	✓	✓	✓
110			✓	✓	✓	✓	✓	✓	✓	✓	✓
120			✓	✓	✓	✓	✓	✓	✓	✓	✓
130				✓	✓	✓	✓	✓	✓	✓	✓
140				✓	✓	✓	✓	✓	✓	✓	✓
150				✓	✓	✓	✓	✓	✓	✓	✓
160				✓	✓	✓	✓	✓		✓	
180				✓	✓	✓	✓	✓	✓	✓	
200				✓	✓	✓		✓		✓	
220						✓					



## Εξάγωνες βίδες σε ίντσες INOX A2

Πάχος→	1/4"	5/16"	3/8"	1/2"	Πάχος→	1/4"	5/16"	3/8"	1/2"
↓Μήκος↓					↓Μήκος↓				
12	✓	✓			60			✓	
16	✓	✓			70			✓	
20	✓	✓	✓		75			✓	
25	✓	✓	✓	✓	87			✓	
32	✓	✓	✓	✓	100			✓	✓
38	✓	✓	✓	✓	110				✓
45	✓	✓	✓	✓					
50	✓	✓	✓	✓					



**Ντίζες DIN976 1 μέτρον** INOX A2**Πάχος Πάχος**

3	16
4	18
5	20
6	22
8	24
10	27
12	30
14	33

**Ντίζες DIN976 1 μέτρον ίντσας** INOX A2**Πάχος Πάχος**

3/16"	9/16"
1/4"	5/8"
5/16"	3/4"
3/8"	7/8"
7/16"	1"
1/2"X13	

**Ανοξείδωτα περικόγλια DIN934** INOX A2**Πάχος Πάχος**

M2	M16
M2,5	M18
M3	M20
M4	M22
M5	M24
M6	M27
M8	M30
M10	M33
M12	M36
M14	

**Περικόγλια ασφαλείας DIN985** INOX A2**Πάχος Πάχος**

M3	M14
M4	M16
M5	M18
M6	M20
M8	M22
M10	M24
M12	

**Περικόγλια ψιλόπασα DIN934** INOX A2**Πάσο**

M8X1
M10X1
M10X1,25
M12X1,25
M12X1,5
M14X1,5
M16X1,5
M18X1,5
M20X1,5

**Περικόγλια στενά DIN439** INOX A2**Πάσο Πάσο**

M4	M14
M5	M16
M6	M18
M8	M20
M10	
M12	

**Περικόγλια τυφλά DIN1587** INOX A2**Πάσο Πάσο**

M3	M12
M4	M14
M5	M16
M6	M18
M8	M20
M10	

**Περικόγλια πεταλούδες DIN315AF** INOX A2**Πάσο**

M3
M4
M5
M6
M8
M10
M12
M14
M16



**Περικόγλια τετράγωνα DIN557** INOX A2**Πάσο**

M6  
M8  
M10  
M12

**Περικόγλια DIN934** INOX A2

αριστερόστροφα

**Πάσο**

M5  
M6  
M8  
M10  
M12  
M16  
M20

**Περικόγλια μούφες DIN6634** INOX A2**Πάσο**

M6  
M8  
M10  
M12  
M16  
M20

**Περικόγλια αντικλεπτικά WS9305** INOX A2

\*αποσπώμενα

**Πάσο**

M6  
M8  
M10  
M12

**Περικόγλια φλαντζωτά WS9345** INOX A2**Πάσο**

M6  
M8  
M10  
M12

**Περικόγλια ασφαλείας DIN980** INOX A2

\*χωρίς πλαστικό

**Πάσο**

M6  
M8  
M10  
M12



**Ροδέλες DIN125** INOX A2**Τύπος** **Τύπος**

3X7	18X34
4X9	20X37
5X10	22X39
6X13	24X44
8X17	27X50
10X21	30X56
12X24	33X60
14X28	36X66
16X30	

**Ροδέλες φαρδιές DIN9021** INOX A2**Τύπος** **Τύπος**

3X9	16X50
4X12	18X56
5X15	20X60
6X18	22X66
8X25	24X72
10X30	27X81
12X40	
14X45	

**Γκρόβερ DIN127B** INOX A2**Οπή** **Οπή**

3	16
4	18
5	20
6	22
8	24
10	27
12	30
14	

**Γκρόβερ αστέρι DIN6798A** INOX A2**Οπή**

3
4
5
6
8
10
12
14
16

**Ροδέλες XL (4xD)** INOX A2**Οπή**

4X16
5X20
6X24
8X32
10X40
12X48

**Πιατάκια μασίφ WS9255** INOX A2**Οπή**

3
4
5
6
8
10
12



Μηχανόβιδες φρεζάτες DIN963 **INOX A2**

Πάχος→	3	4	5	6	8	10
↓Μήκος↓						
3-7	✓	✓	✓			
8	✓	✓	✓			
10	✓	✓	✓	✓		
12	✓	✓	✓	✓		
16	✓	✓	✓	✓		
20	✓	✓	✓	✓		
25	✓	✓	✓	✓		
30	✓	✓	✓	✓		
35	✓	✓	✓	✓		
40						
45			✓	✓		
50		✓	✓	✓		
60		✓	✓	✓		
70				✓		
80				✓	✓	✓
90				✓	✓	
100				✓	✓	✓
120				✓	✓	✓

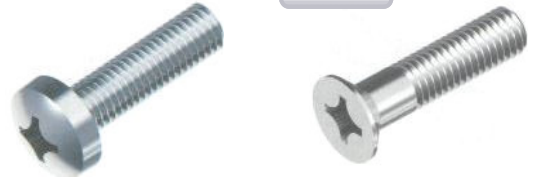
Μηχανόβιδες τραπεζοειδείς - φρεζάτες DIN7985 - DIN965 **INOX A2**

Πάχος→	2	2,5	3	4	5	6	8
↓Μήκος↓							
6	✓	✓	✓	✓			
7	✓	✓					
8	✓	✓	✓	✓	✓		
10	✓	✓	✓	✓	✓		
12	✓	✓	✓	✓	✓	✓	
16	✓	✓	✓	✓	✓	✓	✓
20	✓	✓	✓	✓	✓	✓	✓
25			✓	✓	✓	✓	✓
30			✓	✓	✓	✓	✓
35				✓	✓	✓	✓
40				✓	✓	✓	✓
45				✓	✓	✓	✓
50				✓	✓	✓	✓
60				✓	✓	✓	✓
70					✓	✓	
80					✓	✓	
100							

Μηχανόβιδες πλατυκέφαλες WS9330 **INOX A2**

Πάχος→	3	4	5	6	8
↓Μήκος↓					
10	✓	✓	✓	✓	
12	✓	✓	✓	✓	
16	✓	✓	✓	✓	✓
20	✓	✓	✓	✓	✓
25	✓	✓	✓	✓	✓
30	✓	✓	✓	✓	✓
35			✓	✓	✓
40		✓	✓	✓	✓
50			✓	✓	✓
60			✓	✓	✓

Μηχανόβιδες τραπεζοειδείς DIN84 **INOX A2**

Πάχος→	3	4	5	6
↓Μήκος↓				
3-8	✓	✓	✓	
10	✓	✓	✓	✓
12	✓	✓	✓	✓
16	✓	✓	✓	✓
20	✓	✓	✓	✓
25	✓	✓	✓	✓
30	✓	✓	✓	✓
35		✓	✓	✓
40		✓	✓	✓
45			✓	✓
50			✓	✓
60			✓	✓



## Μηχανόβιδες φακής DIN966 INOX A2



Πάχος→	3	4	5	6	Πάχος→	3	4	5	6
↓Μήκος↓					↓Μήκος↓				
6	✓	✓			25	✓	✓	✓	✓
8	✓	✓			30	✓	✓		✓
10	✓	✓	✓	✓	35		✓	✓	✓
12	✓	✓	✓	✓	40		✓	✓	✓
16	✓	✓		✓	50				✓
20	✓	✓	✓	✓	60			✓	✓



## Μηχανόβιδες πομπέ WS9460

INOX A2



Πάχος→	4	5	6
↓Μήκος↓			
8	✓	✓	
10	✓	✓	✓
12	✓	✓	✓
16			✓
25	✓	✓	
30	✓	✓	✓
35		✓	✓
40		✓	✓

## Μηχανόβιδες φρεζάτες

WS9470 INOX A2



Πάχος→	4	5	6
↓Μήκος↓			
10	✓	✓	
12		✓	✓
16		✓	
20		✓	
25		✓	✓
30			✓

## Μηχανόβιδες πεταλούδα

DIN316AF INOX A2



Πάχος→	4	5	6	8
↓Μήκος↓				
16	✓	✓	✓	✓
20	✓	✓	✓	✓
25	✓	✓	✓	✓
30	✓	✓	✓	✓
40			✓	✓
50			✓	✓

## Κασονόβιδες DIN603 INOX A2



Πάχος→	6	8	10	12	Πάχος→	6	8	10	12
↓Μήκος↓					↓Μήκος↓				
20	✓	✓			90	✓	✓	✓	✓
25	✓	✓	✓	✓	100	✓	✓	✓	✓
30	✓	✓	✓	✓	110			✓	✓
35	✓	✓	✓	✓	120		✓	✓	✓
40	✓	✓	✓	✓	130		✓	✓	✓
45	✓	✓	✓	✓	140		✓	✓	✓
50	✓	✓	✓	✓	150		✓	✓	✓
60	✓	✓	✓	✓	160				✓
70	✓	✓	✓	✓	180				✓
80	✓	✓	✓	✓					

**Βύσματα ντίζας ανοξείδωτα**

INOX A2

TAP



Κωδικός	Τύπος
---------	-------

75204006000	8X25 M6
75204008000	10X30 M8
75204010000	12X40 M10
75204012000	15X50 M12

FRiULSiDER

**Βύσματα ξύλου βιδωτά**

INOX A2

WS9280



Κωδικός	Τύπος
---------	-------

S9280-2-4	M4
S9280-2-5	M5
S9280-2-6	M6
S9280-2-8	M8
S9280-2-10	M10

**Βύσματα ξύλου καρφωτά**

INOX A2

WS9312



Κωδικός	Τύπος
---------	-------

S9312-2-5	M5
S9312-2-6	M6
S9312-2-8	M8
S9312-2-10	M10

**Βύσματα χτυπητά INOX A4**

FM753 inox



Κωδικός	Τύπος	Κωδικός	Τύπος
---------	-------	---------	-------

75320006065	M6X65mm	75320010120	M10X120mm
75320006085	M6X85mm	75320012080	M12X80mm
75320008075	M8X75mm	75320012110	M12X110mm
75320008090	M8X90mm	75320012135	M12X135mm
75320008115	M8X115mm	75320012160	M12X160mm
75320010075	M10X75mm		
75320010090	M10X90mm		

FRiULSiDER

**Βύσματα χτυπητά INOX A2**

Τύπος	Τύπος
-------	-------

8X75	12X110
8X90	12X135
8X115	12X160
10X75	16X125
10X90	16X145
10X120	16X180
10X145	
12X80	



## Αλενόβιδες σε μετρικό DIN912 INOX A2



Πάχος→	3	4	5	6	8	10	12	14	16
↓Μήκος↓									
3-6	✓	✓							
8	✓	✓	✓						
10	✓	✓	✓	✓	✓				
12	✓	✓	✓	✓	✓				
16	✓	✓	✓	✓	✓	✓			
20	✓	✓	✓	✓	✓	✓	✓		
25	✓	✓	✓	✓	✓	✓	✓	✓	✓
30	✓	✓	✓	✓	✓	✓	✓	✓	✓
35		✓	✓	✓	✓	✓	✓	✓	✓
40	✓	✓	✓	✓	✓	✓	✓	✓	✓
45			✓	✓	✓	✓	✓	✓	✓
50		✓	✓	✓	✓	✓	✓	✓	✓
60			✓	✓	✓	✓	✓	✓	✓
70				✓	✓	✓	✓	✓	✓
80				✓	✓	✓	✓	✓	✓
90				✓	✓	✓	✓	✓	✓
100				✓	✓	✓	✓	✓	✓
110					✓	✓	✓		
120					✓	✓	✓		
130					✓	✓	✓		
140					✓	✓	✓		
150					✓	✓	✓		



## Αλενόβιδες ακέφαλες DIN916 INOX A2



Πάχος→	3	4	5	6	8	10	12
↓Μήκος↓							
3	✓						
4	✓	✓					
5	✓	✓	✓				
6	✓	✓	✓	✓			
8	✓	✓	✓	✓	✓		
10	✓	✓	✓	✓	✓	✓	
12	✓	✓	✓	✓	✓	✓	✓
16	✓	✓	✓	✓	✓	✓	✓
20		✓	✓	✓	✓	✓	✓
25		✓	✓	✓	✓	✓	✓
30				✓	✓	✓	✓
35					✓	✓	✓
40				✓	✓	✓	✓
50					✓	✓	

## Αλενόβιδες φρεζάτες DIN7991 INOX A2



Πάχος→	4	5	6	8	10	12
↓Μήκος↓						
10	✓	✓	✓			
12	✓	✓	✓			
16	✓	✓	✓	✓		
20	✓	✓	✓	✓	✓	✓
25	✓	✓	✓	✓	✓	✓
30	✓	✓	✓	✓	✓	✓
35	✓	✓	✓	✓	✓	✓
40	✓	✓	✓	✓	✓	✓
45		✓	✓	✓	✓	✓
50		✓	✓	✓	✓	✓
60			✓	✓	✓	✓
70				✓	✓	✓
80				✓	✓	✓
90					✓	✓
100					✓	✓

## Αλενόβιδες πομπέ DIN7380

INOX A2



Πάχος→	4	5	6	8	10
↓Μήκος↓					
10	✓	✓			
12	✓	✓			
16	✓	✓	✓	✓	
20	✓	✓	✓	✓	✓
25	✓	✓	✓	✓	✓
30	✓	✓	✓	✓	✓
35		✓	✓	✓	✓
40		✓	✓	✓	✓
50			✓	✓	✓
60					

## Αλενόβιδες ίντζας DIN912

INOX A2



Πάχος→	1/4"	5/16"	3/8"
↓Μήκος↓			
12			
16	✓	✓	
20	✓	✓	✓
25	✓	✓	✓
30	✓	✓	✓
35	✓		
40		✓	✓
45		✓	✓
50			✓

## Αλενόβιδες με κοντό κεφάλι

DIN6912 INOX A2



Πάχος→	6	8	10
↓Μήκος↓			
10	✓	✓	
12	✓	✓	
16	✓	✓	✓
20	✓	✓	✓
25	✓	✓	✓
30	✓	✓	✓



**Νοβοπανόβιδες WS9100** INOX A2



Πάχος→	3	3,5	4	5	6
↓Μήκος↓					
13	✓	✓			
16	✓	✓	✓		
20	✓	✓	✓	✓	
25	✓	✓	✓	✓	
30	✓	✓	✓	✓	✓
35		✓	✓	✓	✓
40			✓	✓	✓
45			✓	✓	✓
50			✓	✓	✓
60			✓	✓	✓
70				✓	✓
80				✓	✓
90				✓	✓
100				✓	✓
120					✓

**Νοβοπανόβιδες WS9130** INOX A2

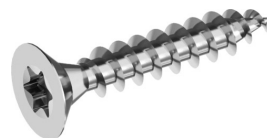

Πάχος→	3	3,5	4	5	6
↓Μήκος↓					
16	✓				
20	✓	✓	✓	✓	
25		✓	✓	✓	
30	✓	✓	✓	✓	✓
35			✓	✓	
40			✓	✓	✓
50			✓	✓	✓
60			✓	✓	✓
70					✓
80					✓
100					✓

**Στριφώνια DIN751** INOX A2



Πάχος→	6	8	10	12
↓Μήκος↓				
30	✓			
35	✓			
40	✓	✓		
45	✓			
50	✓	✓	✓	✓
60	✓	✓	✓	✓
70	✓	✓	✓	✓
80	✓	✓	✓	✓
90	✓	✓	✓	✓
100	✓	✓	✓	✓
110		✓	✓	✓
120	✓	✓	✓	✓
130		✓	✓	✓
140		✓	✓	✓
150		✓	✓	✓
160		✓	✓	✓
180		✓	✓	✓
200				✓

**Στριφονόβιδες WS9210** INOX A2

Πάχος→	8	10
↓Μήκος↓		
80	✓	✓
90		✓
100	✓	✓
120	✓	✓
140	✓	✓



**Στριφονόβιδες WS9211** INOX A2



**Περιγραφή**

- M10x180mm
- M10x250mm
- M10x300mm
- M12x300mm
- M12x350mm

**Ευλόβιδες ψωμάκι torx** INOX A2

**Περιγραφή**

- 4,8x32mm T20
- 4,8x38mm T20
- 4,8x50mm T20
- 4,8x60mm T20



## Λαμαρινόβιδες τραπεζοειδείς - φρεζάτες DIN7981 - DIN7982 INOX A2

Πάχος→	(3) 2,2	(4) 2,9	(6) 3,5	(8) 4,2	(10) 4,8	(12) 5,5	(14) 6,3
↓Μήκος↓							
6,5 (¼")	✓	✓	✓				
9,5 (⅜")	✓	✓	✓	✓			
13 (½")		✓	✓	✓	✓	✓	
16 (⅝")		✓	✓	✓	✓	✓	✓
19 (¾")		✓	✓	✓	✓	✓	✓
25 (1")		✓	✓	✓	✓	✓	✓
32 (1¼")		✓	✓	✓	✓	✓	✓
38 (1½")				✓	✓	✓	✓
45 (1¾")							✓
50 (2")				✓	✓	✓	✓
60 (2½")				✓	✓	✓	✓



## Λαμαρινόβιδες WS9200

INOX A2



Πάχος→	4,8	5,5	6,3
↓Μήκος↓			
13	✓		
16	✓	✓	✓
19	✓	✓	✓
25	✓	✓	✓
32	✓	✓	✓
38	✓	✓	✓
50	✓	✓	✓
60		✓	✓
70			✓

## Λαμαρινόβιδες εξάγωνες DIN7976

INOX A2



Πάχος→	6,3
↓Μήκος↓	
13	✓
16	✓
19	✓
25	✓
32	✓
38	✓
50	✓

## Λαμαρινόβιδες φρεζάτες φακή DIN7983

INOX A2



Πάχος→	2,9	3,5	4,2	4,8	5,5	6,3
↓Μήκος↓						
6,5	✓					
9,5	✓		✓			
13	✓	✓	✓	✓		
16	✓	✓	✓	✓	✓	✓
19	✓	✓	✓	✓	✓	✓
25	✓	✓	✓	✓	✓	✓
32		✓	✓	✓	✓	✓
38		✓	✓	✓	✓	✓
50			✓	✓	✓	✓
60				✓	✓	✓

## Τρυπανόβιδες φρεζάτες DIN7504P

INOX A2



Πάχος→	4,2	4,8
↓Μήκος↓		
13	✓	
16	✓	✓
19	✓	✓
25	✓	✓
32	✓	✓
38	✓	✓
50		✓

## Τρυπανόβιδες πομπέ DIN7504N

INOX A2



Πάχος→	3,5	4,2	4,8
↓Μήκος↓			
13	✓	✓	
16	✓	✓	✓
19		✓	✓
22	✓		
25	✓	✓	✓
32		✓	✓
38		✓	✓

## Τρυπανόβιδες εξάγωνες DIN7504K

INOX A2

Πάχος→	4,2	4,8	5,5	6,3
↓Μήκος↓				
13	✓			
16	✓			
19	✓	✓	✓	✓
25	✓	✓	✓	✓
32	✓	✓	✓	✓
38		✓	✓	✓
45		✓	✓	
50		✓	✓	✓
70			✓	
80			✓	

**Ασφάλειες άξονος DIN471** INOX A2

Τύπος	Τύπος	Τύπος	Τύπος	Τύπος
A5	A14	A24	A36	A65
A6	A15	A25	A38	A70
A7	A16	A26	A40	A75
A8	A17	A27	A42	A80
A9	A18	A28	A45	A100
A10	A19	A29	A48	
A11	A20	A30	A50	
A12	A22	A32	A55	
A13	A23	A35	A60	

**Ασφάλειες τρύπας DIN472** INOX A2

Τύπος	Τύπος	Τύπος	Τύπος	Τύπος
B8	B19	B32	B48	B75
B9	B20	B34	B50	B80
B10		B35	B52	B90
B11	B22	B36	B55	B95
B12	B24	B37	B60	B100
B13	B25	B38	B62	
B14	B26	B40	B65	
B16	B27	B42	B68	
B17	B28	B45	B70	
B18	B30	B47	B72	

**Κοπίλιες DIN94** INOX A2

Τύπος	Τύπος	Τύπος	Τύπος	Τύπος
1,6X20	2X50	3,2X36	4X45	5X80
1,6X25	2,5X20	3,2X40	4X50	5X100
1,6X32	2,5X25	3,2X45	4X63	6,3X40
1,6X40	2,5X32	3,2X50	4X80	6,3X45
2X20	2,5X36	3,2X63	5X32	6,3X50
2X25	2,5X40	4X20	5X36	6,3X63
2X32	2,5X50	4X25	5X45	6,3X100
2X36	3,2X20	4X32	5X50	
2X40	3,2X25	4X36	5X63	
2X45	3,2X32	4X40	5X71	

**Σφήνες DIN6885** INOX A2

Τύπος	Τύπος	Τύπος
5X5X16	6X6X45	8X7X60
5X5X20	6X6X50	10X8X30
5X5X25	6X6X60	10X8X40
5X5X30	8X7X20	10X8X50
6X6X16	8X7X25	10X8X60
6X6X20	8X7X30	12X8X40
6X6X25	8X7X36	12X8X50
6X6X30	8X7X40	12X8X60
6X6X35	8X7X45	12X8X70
6X6X40	8X7X50	

**Σφήνες μέτρου DIN6885** INOX A2

Τύπος
5X5X1000
6X6X1000
8X7X1000
10X8X1000
12X8X1000
14X9X1000
16X10X1000

\*το τεμάχιο



**Σφήνες του μέτρου** INOX A2**Τύπος**

6X6  
8X7  
10X8  
12X8

**Ασφάλειες μισοφέγγαρες DIN6799** INOX A2**Τύπος**

Τύπος	Τύπος
Z1,9	Z8
Z3	Z9
Z4	Z10
Z5	Z12
Z6	Z15
Z7	

**Μποζόνια DIN939** INOX A2**Τύπος**

6X30  
6X40  
8X30  
8X40  
8X50  
10X30  
10X50

**Καβίλιες DIN1481** INOX A2

Τύπος	Τύπος	Τύπος	Τύπος
2X10	4X16	5X36	8X30
2X16	4X20	5X40	8X40
2X20	4X24	5X50	8X50
2,5X10	4X30	6X20	8X60
2,5X16	4X36	6X24	10X50
2,5X20	4X40	6X30	10X60
3X16	5X16	6X36	
3X20	5X20	6X40	
3X24	5X24	6X50	
3X30	5X30	6X60	

**Περόνες M8377** INOX A4

D	L	D1	A	H
2,0mm	47mm	12mm	13mm	3mm
2,5mm	64mm	16mm	23mm	5mm
3,0mm	68mm	20mm	24mm	6mm
4,0mm	84mm	22mm	27mm	7mm
5,0mm	97mm	24mm	35mm	7mm
6,0mm	108mm	24mm	39mm	7mm

**Περόνες M8378** INOX A4

D	L	D1
2,5mm	42mm	20mm
3,2mm	48mm	20mm
4,0mm	64mm	20mm
5,0mm	80mm	25mm
6,3mm	97mm	25mm
7,0mm	125mm	30mm
8,0mm	150mm	30mm

**Πίροι εντατήρα M8144 INOX A4**

D	L	N	D	L	N
B 4mm	19mm	16mm	N 8mm	21mm	17mm
C 5mm	15mm	11mm	O 8mm	24mm	20mm
D 5mm	18mm	14mm	P 8mm	27mm	23mm
E 5mm	21mm	17mm	Q 8mm	32mm	28mm
F 6mm	15mm	11mm	R 9,5mm	26mm	22mm
G 6mm	20mm	16mm	S 9,5mm	30mm	26mm
H 6mm	25mm	21mm	T 10mm	30mm	26mm
I 6mm	29mm	25mm	U 11mm	30mm	25mm
J 6mm	36mm	32mm	V 12mm	30mm	26mm
K 6mm	45mm	41mm	W 15mm	41mm	36mm

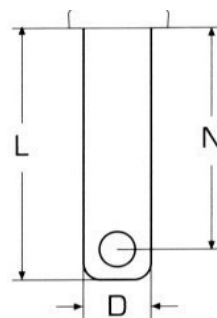
**Πίροι εντατήρα ασφαλείας M8356 INOX A4**

D	L1	L2
6mm	65mm	60mm
8mm	28mm	20mm
10mm	35mm	25mm

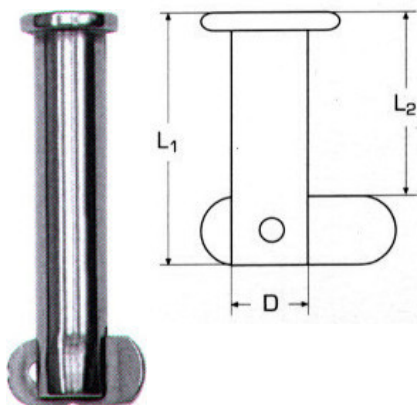
**Πίροι εντατήρα με μπίλια και κρίκο M8374 INOX A4**

D	L1	L2
5mm	25mm	17mm
6mm	25mm	17mm
8mm	25mm	17mm
10mm	38mm	26mm

**Ασφάλειες πίρου M8383 INOX A4**

D1	D2
1mm	11mm
1,25mm	15mm
1,5mm	19mm
2mm	23mm

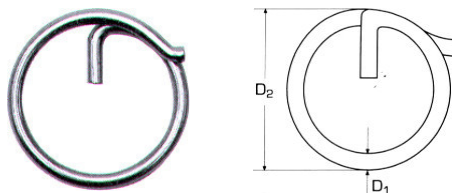
**Ασφάλειες εντατήρα M8155 INOX A4**

D	D1
1,5mm	18mm
1,5mm	22mm
1,5mm	26mm
1,5mm	30mm

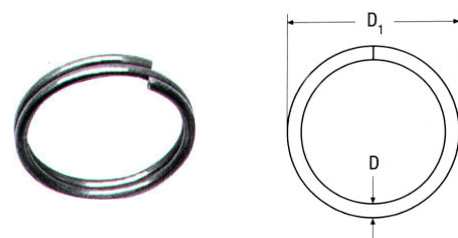
**Γάντζοι "S" M8160 INOX A4**

D	L	W	S
3mm	24mm	9mm	4mm
4mm	32mm	12mm	6mm
5mm	40mm	15mm	7mm
6mm	48mm	17mm	8mm
8mm	64mm	24mm	12mm

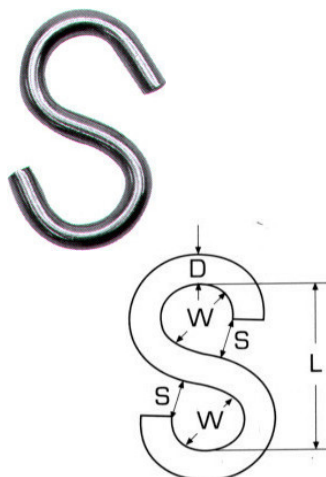
**Δέλτα M8376 INOX A4**

D	L	W
3mm	15mm	12mm
3mm	20mm	12mm
4mm	20mm	17mm
4mm	25mm	22mm
4mm	30mm	27mm
5mm	25mm	22mm
5mm	30mm	27mm
6mm	30mm	27mm
6mm	40mm	37mm
6mm	50mm	47mm
8mm	50mm	47mm

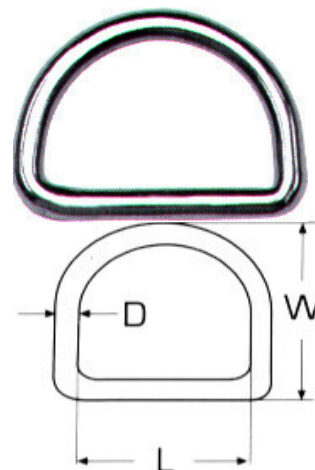

**Κρίκοι M8229 INOX A4**

D	W	D	W
3mm	20mm	6mm	60mm
3mm	30mm	6mm	80mm
4mm	25mm	8mm	40mm
4mm	30mm	8mm	50mm
4mm	35mm	8mm	80mm
4mm	40mm	8mm	100mm
5mm	30mm	10mm	50mm
5mm	40mm	10mm	60mm
5mm	50mm	10mm	70mm
6mm	35mm	10mm	80mm
6mm	40mm	10mm	100mm
6mm	45mm		

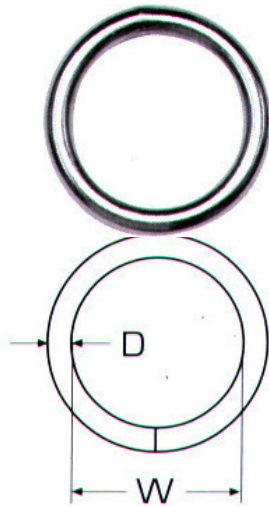

**Περτσίνια με πάσο INOX A2**



Πάσο	Διάμετρος	Κεφάλι	Μήκος
M4	5,9mm	9mm	11,5mm
M5	6,8mm	12,3mm	13,3mm
M6	8,9mm	12mm	16mm
M8	10,9mm	15mm	18,5mm
M10	12,8mm	17mm	18,9mm

**Περτσίνια φρεζάτα DIN661 INOX A2**

Πάχος→	3	4	5	6
6	✓			
8	✓	✓		
10	✓	✓	✓	
12	✓	✓	✓	✓
16	✓	✓	✓	✓
20	✓	✓		
25		✓	✓	✓
30		✓		✓



**Περτσίνια στρογγυλοκέφαλα DIN660 INOX A2**

Πάχος→	3	4	5	6
6		✓	✓	
8	✓	✓	✓	
10	✓	✓	✓	
12	✓	✓	✓	
16	✓	✓		✓
20	✓	✓	✓	✓
25			✓	✓
30		✓		✓



**Πρεσαριστή τάπα M8558 INOX A4**



**Τύπος**

3X18
4X24
5X28
6X32

**Περτσίνια INOX A2**

Πάχος→	3,2	4,0	4,8
6	✓	✓	
8	✓	✓	
10	✓	✓	✓
12	✓	✓	✓
14	✓	✓	
16	✓	✓	✓
20		✓	✓
25			✓
30			✓

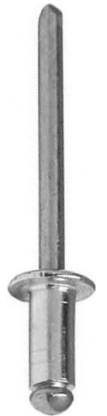



**Μεντεσέδες σωλήνων M8136** INOX A4

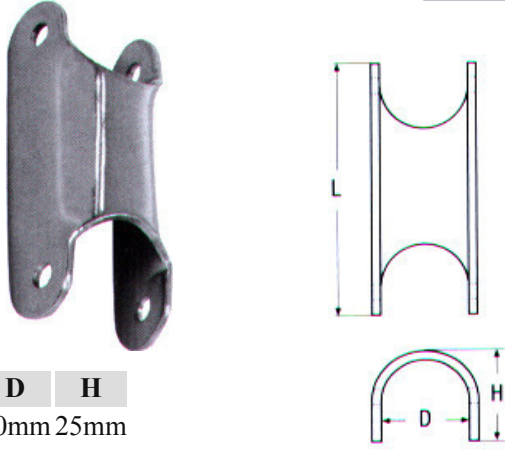

**L D H**  
70mm 20mm 25mm

**Μεντεσέδες με διπλό πύρο M8018** INOX A4

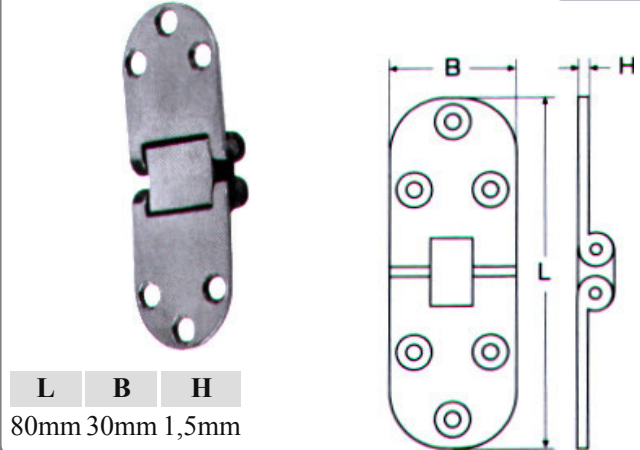

**L B H**  
80mm 30mm 1,5mm

**Μεντεσέδες χυτοί M8233** INOX A4

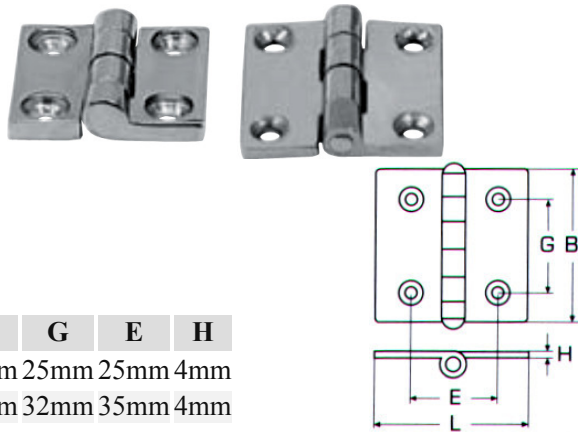

**L B G E H**  
38mm 38mm 25mm 25mm 4mm  
50mm 50mm 32mm 35mm 4mm

**Μεντεσέδες χυτοί M8234** INOX A4

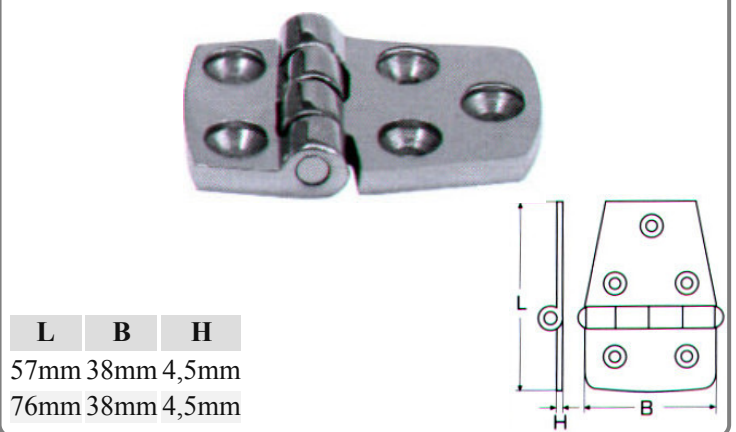

**L B H**  
57mm 38mm 4,5mm  
76mm 38mm 4,5mm

**Μεντεσέδες χυτοί στρόγγυλοι M8428** INOX A4

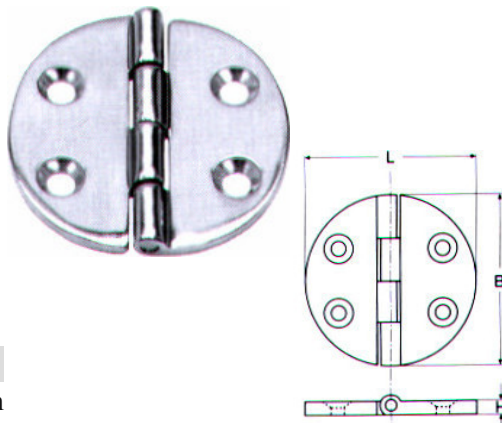

**L B H**  
64mm 64mm 4mm

**Μεντεσέδες M8429** INOX A4

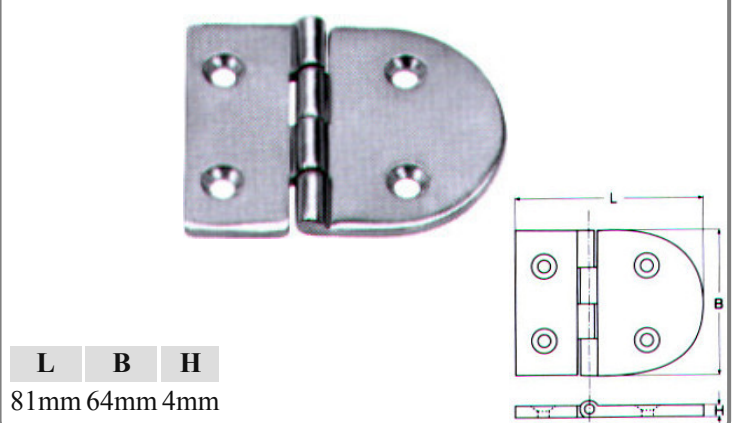

**L B H**  
81mm 64mm 4mm

**Μεντεσέδες με πύρο M8238** INOX A4

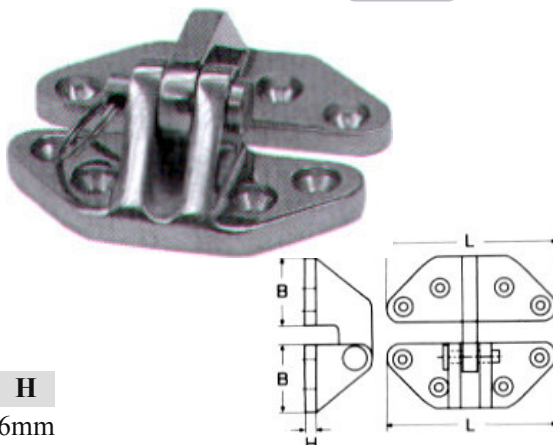

**L B H**  
71mm 28mm 6mm

**Μεντεσέδες μακρόστενοι M8235** INOX A4

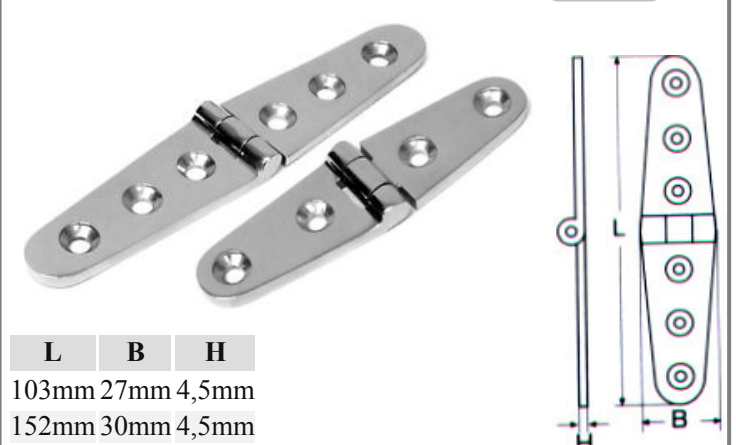

**L B H**  
103mm 27mm 4,5mm  
152mm 30mm 4,5mm



**Μεντεσέδες με γόνατο M8237** INOX A4

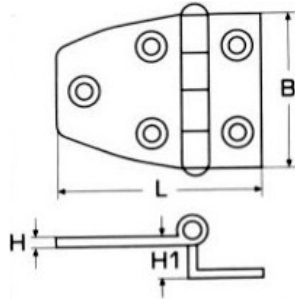

L	B	H	H1
54mm	37mm	4,5mm	14mm
70mm	37mm	4,5mm	14mm

**Μεντεσέδες χυτοί διαρούμενοι M8239** INOX A4

\*η φωτογραφία δείχνει δεξιό

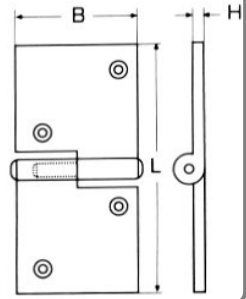

Τύπος	L	B	H
Αριστερός	92mm	36mm	5mm
Δεξιός	92mm	36mm	5mm

**Μεντεσέδες χυτοί M8280** INOX A4

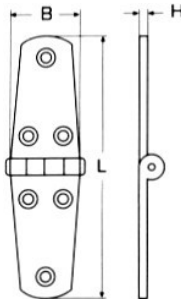

Τύπος	L	B	H
A	76mm	38mm	4,5mm
B	102mm	38mm	4,5mm

**Μεντεσέδες χυτοί τύπου "T" M8281** INOX A4

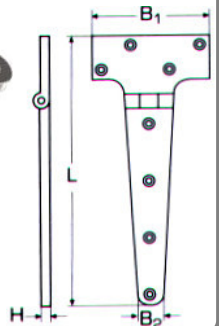

L	B1	B2	H
195mm	98mm	20mm	5mm

**Μεντεσέδες οβάλ M8045** INOX A4

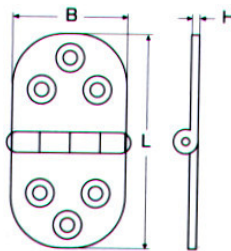
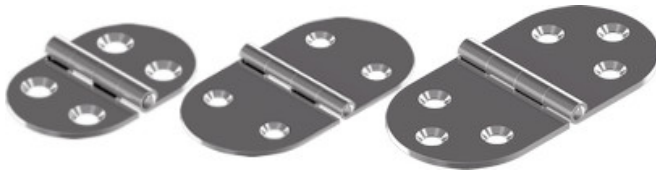

L	B	H
47mm	30mm	1,5mm
75mm	40mm	1,5mm
80mm	40mm	2,5mm

**Μεντεσέδες μακρόστενοι M8046** INOX A4

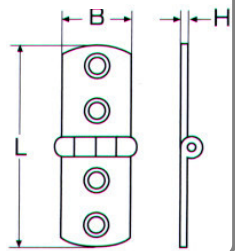

L	B	H
75mm	20mm	1,5mm
85mm	30mm	1,5mm
100mm	40mm	1,5mm

**Μεντεσέδες μακρόστενοι M8047** INOX A4

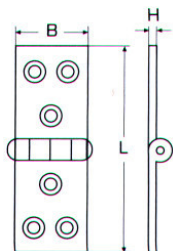
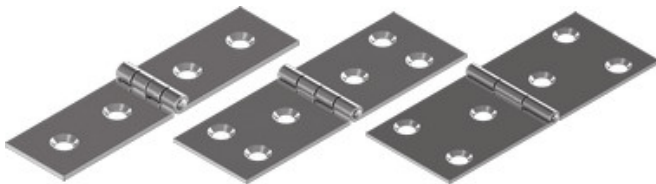

L	B	H
80mm	20mm	1,5mm
90mm	30mm	1,5mm
100mm	40mm	1,5mm

**Μεντεσέδες M8043** INOX A4

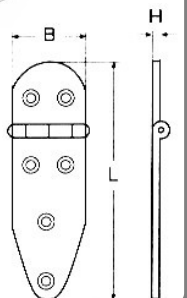

L	B	H
130mm	40mm	1,5mm



**Μεντεσέδες M8044 INOX A4**

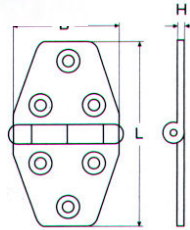

L	B	H
70mm	40mm	1,5mm

**Μεντεσέδες M8048 INOX A4**

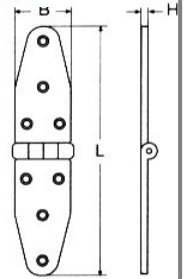
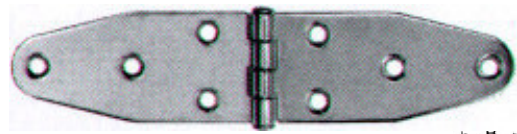

L	B	H
185mm	40mm	1,5mm

**Μεντεσέδες M8151 INOX A4**

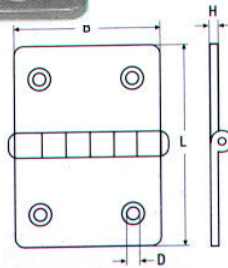
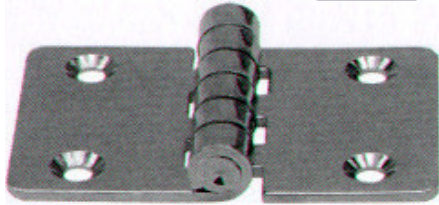

L	B	H	D
90mm	60mm	3mm	6,1mm

**Μεντεσέδες M8152 INOX A4**

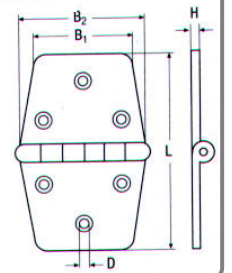

L	B	B1	B2	D
95mm	38mm	60mm	2mm	5,6mm

**Μεντεσέδες ART1228 INOX A4**

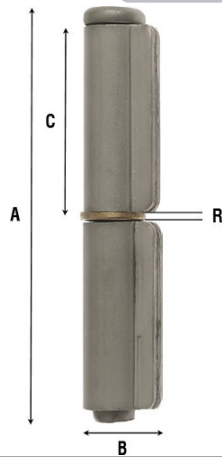

No	A	B	C	R	Ø
6	60	15	27	2	12
8	80	15	37	2	12
10	100	18	46	2,2	14,5
12	120	21	55	2,2	14,5



**Μεντεσέδες ART1229 INOX A4**



No	A	B	C	C1	R
14	140	21	32	65	2



**Μεντεσέδες δίμετροι INOX A2**

**Τύπος**

- 25X0,7
- 30X0,7
- 38X0,7
- 38X1,2
- 50X0,7
- 50X1,2
- 50X2,0
- 60X1,2
- 60X2,0
- 70X2,0
- 70X3,0



**Μεντεσέδες M8049 INOX A4**

L	B	H	D
A	30	40	1,5 3,9
B	40	40	1,5 4,5
C	40	60	1,5 4,5
D	50	60	1,5 5,5
E	60	60	1,5 4,5
F	50	80	1,5 4,5
G	60	80	1,5 4,5
H	70	80	1,5 4,5
I	80	80	1,5 4,5
P	100	100	1,5 4,5

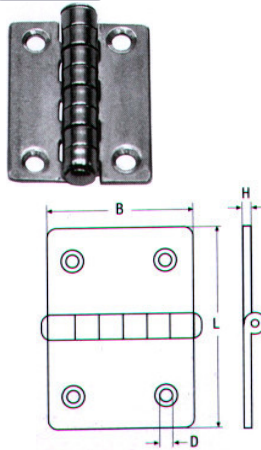

**Μεντεσέδες M8150 INOX A4**

L	B	H	D
A	25	30	0,8 4,5
B	28,5	30	0,8 4,5
C	35	40	0,8 4,5
D	40	40	0,8 4,5
E	40	50	0,8 4,5
F	50	50	0,8 4,5
G	50	60	0,8 4,5
H	55	70	0,8 4,5

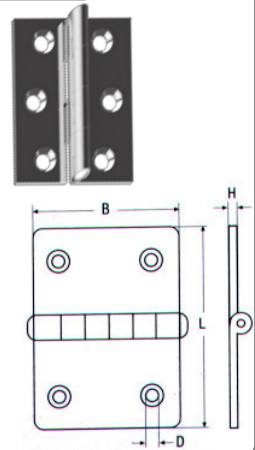

**Μεντεσέδες πλακέ AKSSSN20 INOX A4**

Μήκος	Πλάτος	Πάχος
3"	3"	2mm
3½"	3½"	2mm
4"	3"	2mm
4"	3½"	2mm
4"	4"	2mm

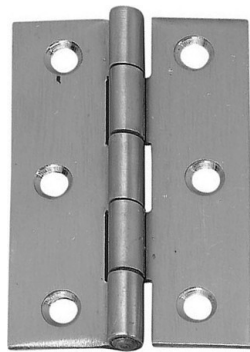

**Μεντεσέδες με ρουλεμάν AKSSSB20 INOX A4**

Μήκος	Πλάτος	Πάχος
3"	3"	2mm
3½"	3½"	2mm
4"	3"	2mm
4"	3½"	2mm
4"	4"	2mm
3"	3"	3mm
3½"	3½"	3mm
4"	3"	3mm
4"	3½"	3mm
4"	4"	3mm
4½"	4"	3mm
4½"	4½"	3mm



**Μεντεσέδες ρόμβου ART854 INOX A4**

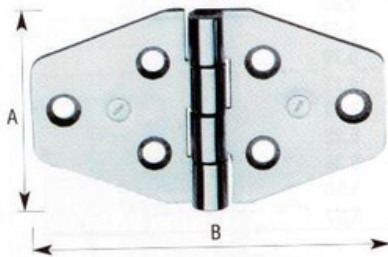

A	B
40mm	70mm



**Μεντεσέδες ρόμβου κοφτοί ART852 INOX A4**

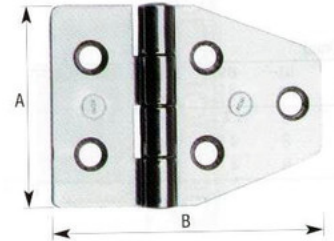

A	B
40mm	55mm



**Μεντεσέδες διαιρούμενοι αριστεροί INOX 18/8**



Κωδικός	A	B
7324	60mm	40mm
7326	70mm	50mm



**Μεντεσέδες διαιρούμενοι δεξιοί INOX 18/8**



Κωδικός	A	B
7323	60mm	40mm
7325	70mm	50mm





### Μεντεσέδες αλέ ρετούρ **INOX 18/8**

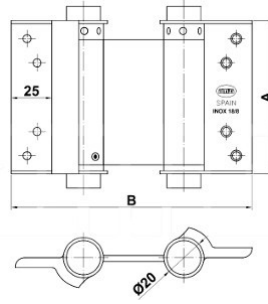

Κωδικός	A	B	Πλάτος πόρτας	Πάχος πόρτας	Βάρος πόρτας
7376	77mm	130mm	65mm	≤28mm	≤16kg



**Καταβάτες γωνιακοί ART1140&ART1142**

INOX A4

Δέχεται λουκέτο



A	B
83mm	25mm

**Μάνταλα πόρτας M8181**

INOX A4



L1	W	L2
63mm	19mm	40mm

**Ζεμπερέκια πόρτας M8384**

INOX A4



L	A	B
100mm	24mm	38mm

**Ζεμπερέκια πόρτας M8708**

INOX A4



L	D
80mm	4mm
100mm	4mm
100mm	4,5mm
100mm	5,2mm

**Καταβάτες M8518**

INOX A4

Δέχεται λουκέτο

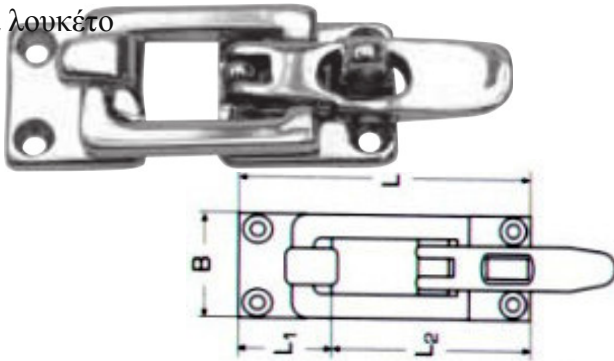

L	B	L1	L2
70mm	28mm	25mm	45mm

**Καταβάτες M8053A**

INOX A4



**Δύναμη**  
0,5kN

**Καταβάτες γωνιακοί M8519**

INOX A4

Δέχεται λουκέτο

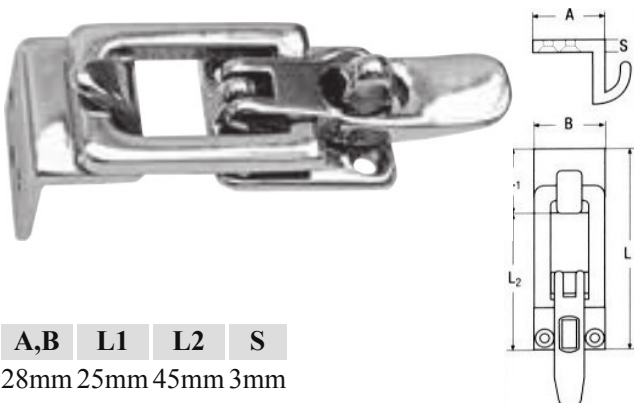

L	A,B	L1	L2	S
70mm	28mm	25mm	45mm	3mm

**Καταβάτες M8053B**

INOX A4



**Δύναμη**  
0,5kN



**Καταβάτες M8053C** INOX A4

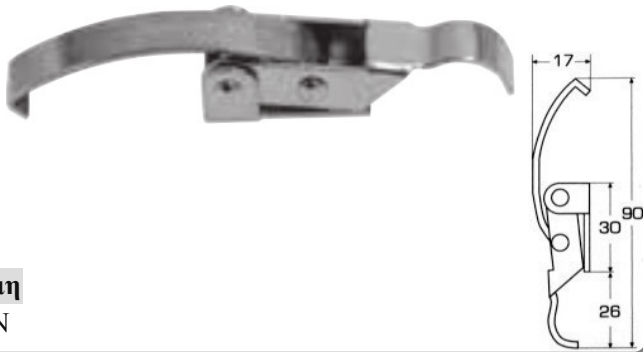

**Δύναμη**  
0,5kN

**Καταβάτες M8053D** INOX A4

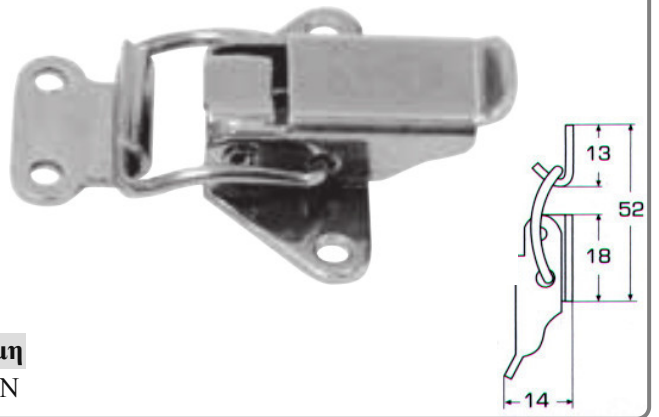

**Δύναμη**  
0,55kN

**Καταβάτες M8053F** INOX A4



**Δύναμη**  
0,2kN

**Καταβάτες M8053G** INOX A4



**Δύναμη**  
1kN

**Καταβάτες M8053H** INOX A4



**Δύναμη**  
2kN

**Καταβάτες M8053O** INOX A4

Δέχεται λουκέτο



**Δύναμη**  
0,55kN

**Καταβάτες M8053P** INOX A4

Δέχεται λουκέτο



**Δύναμη**  
1kN

**Καταβάτες M8053Q** INOX A4

Δέχεται λουκέτο



**Δύναμη**  
0,2kN

**Καταβάτες M8053I** INOX A4

**Δύναμη**  
1kN

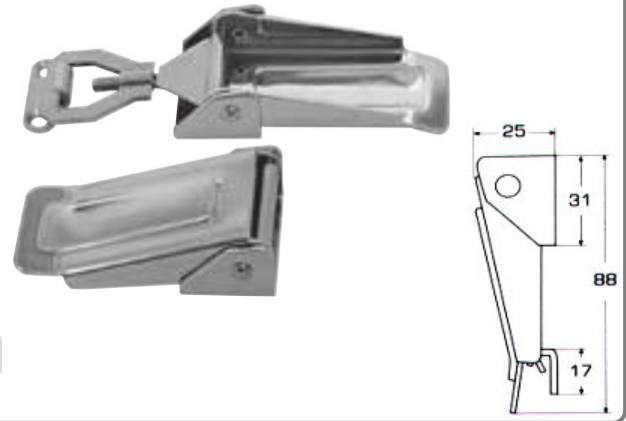
**Καταβάτες M8053L** INOX A4

**Δύναμη**  
1,5kN

**Καταβάτες M8053M** INOX A4

**Δύναμη**  
1,1kN

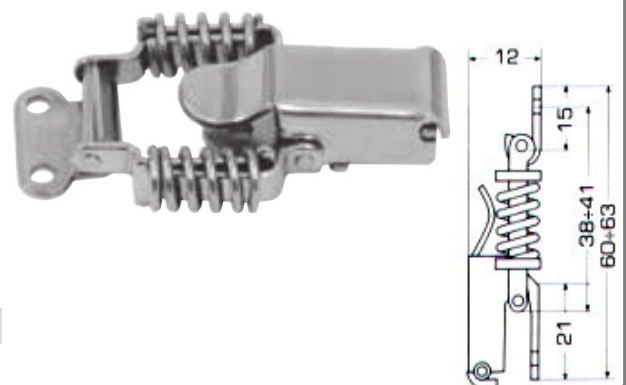
**Καταβάτες M8053N** INOX A4

**Δύναμη**  
1,1kN

**Καταβάτες κυψελών 73X25mm** INOX A2

Δέχεται λουκέτο

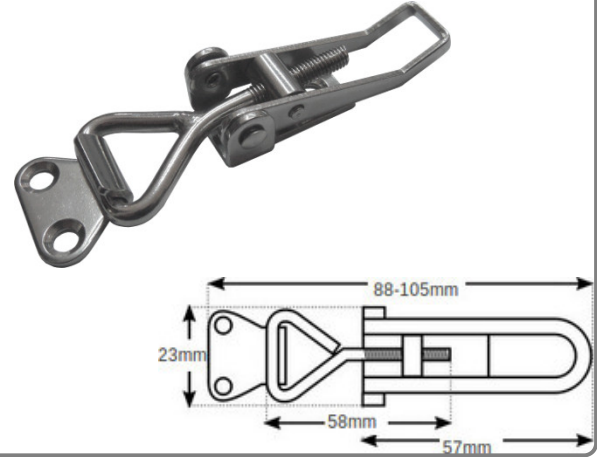

**Κωδικός**  
DL032

**Καταβάτες κυψελών 5mm** INOX A2

**Κωδικός**  
DL001

**Καταβάτες κυψελών 6mm** INOX A2

Δέχεται λουκέτο

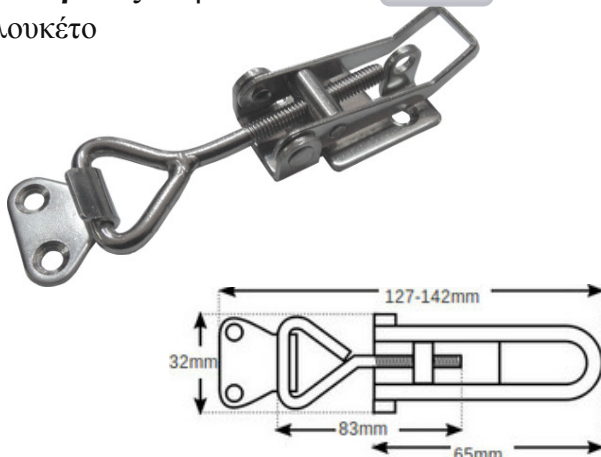

**Κωδικός**  
DL004

**Καταβάτες κυψελών 8mm** INOX A2

Δέχεται λουκέτο

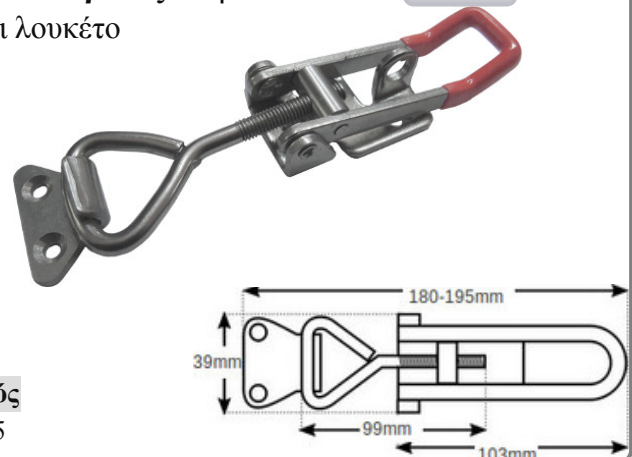

**Κωδικός**  
DL005

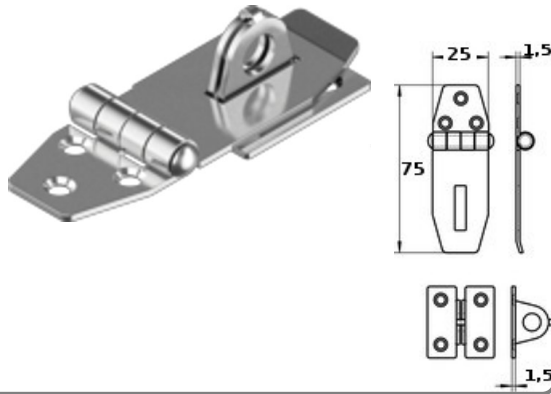
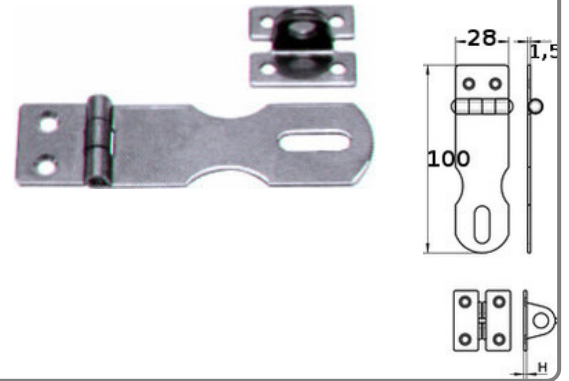
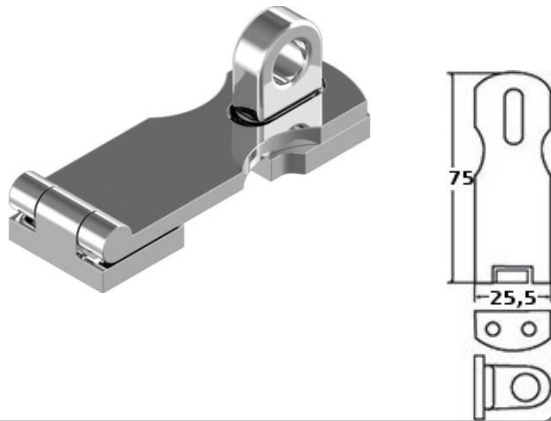
**Καταβάτες πλακέ M8052A** INOX A4**Καταβάτες πλακέ M8052** INOX A4**Καταβάτες M8050** INOX A4**Σύρτες πλακέ** INOX A4

Κωδικός	Μήκος
AKCH482-611150	50mm
AKCH482-611165	65mm

**Σύρτες με στρόγγυλο πύρο** INOX A4

Κωδικός	Μήκος
AKA350-1	90mm
AKA350-1	150mm

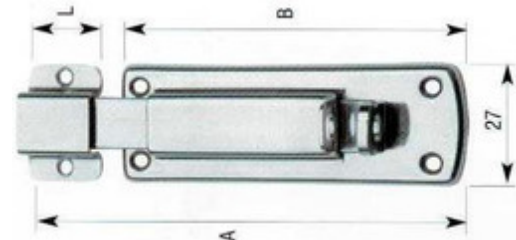
**Σύρτες πλακέ** INOX A4

Κωδικός	A	B	L
ART214-8	85mm	67mm	18mm
ART214-10	100mm	82mm	18mm

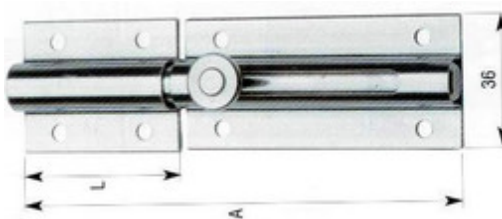
**Σύρτες με στρόγγυλο πύρο** INOX A4

Κωδικός	A	L
ART216-8	80,5mm	30mm
ART216-12	120,5mm	45mm

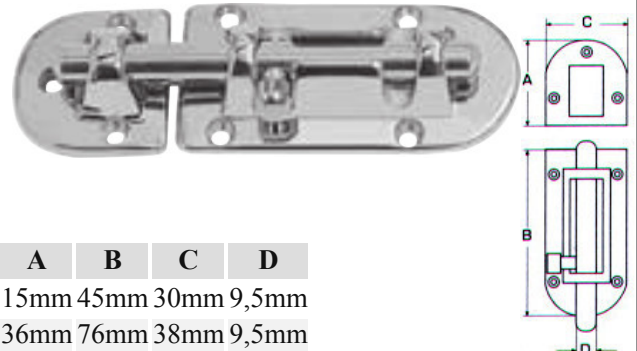
**Σύρτες με στρόγγυλο πύρο M8333** INOX A4

Τύπος	A	B	C	D
A	15mm	45mm	30mm	9,5mm
B	36mm	76mm	38mm	9,5mm



Δέχεται λουκέτο

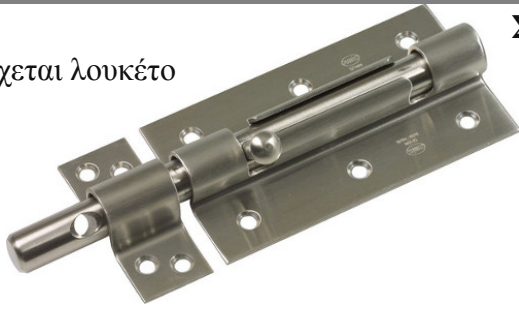

## Σύρτες πόρτας INOX 18/8

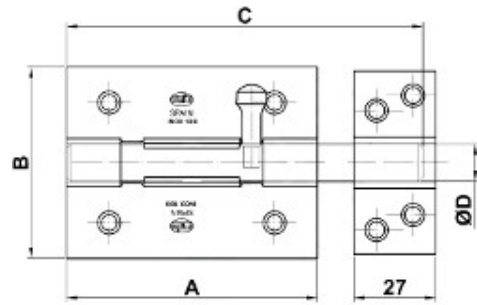

Κωδικός	A	B	L	C	Οπές
14176	70mm	67mm	104mm	13mm	4
14177	85mm	67mm	126mm	13mm	4
14178	100mm	67mm	146mm	13mm	6
14179	120mm	67mm	184mm	15mm	6



## Σύρτες πόρτας INOX 18/8

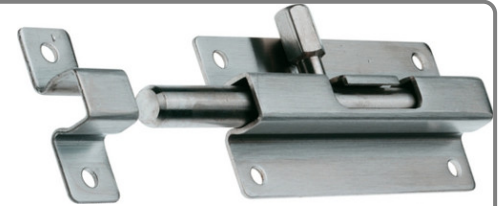

Κωδικός	A	B	C	D	E	F	H
17942	25mm	16mm	20mm	6,5mm	12mm	0,8mm	14mm
7445	30mm	21mm	20mm	6,5mm	12mm	0,8mm	19mm
6517	40mm	28mm	27mm	9mm	14mm	1,2mm	26mm
6518	50mm	38mm	27mm	9mm	14mm	1,2mm	26mm
6519	65mm	53mm	27mm	9mm	14mm	1,2mm	26mm
6520	80mm	68mm	27mm	9mm	14mm	1,2mm	26mm
8068	100mm	88mm	27mm	9mm	14mm	1,2mm	36mm

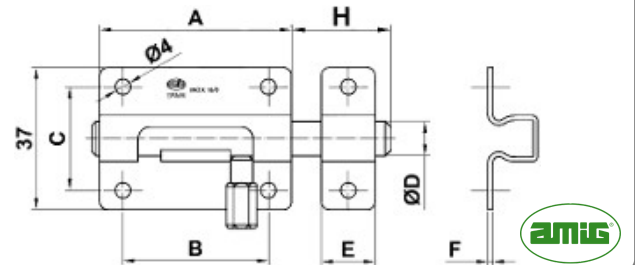

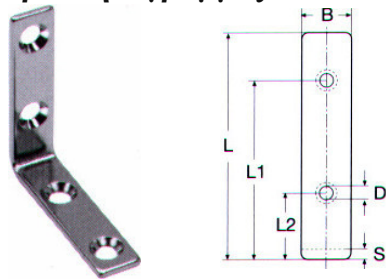
**Γωνίες παραλληλόγραμμα M8340** INOX A4

L	L1	L2	B	S	D
A 31mm	25mm	12mm	12mm	3mm	4mm
B 46mm	38mm	18mm	13mm	3mm	4mm
C 61mm	51mm	21mm	15mm	3mm	4mm

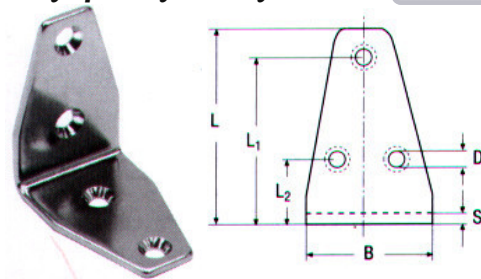
**Γωνίες τραπεζοειδείς M8341** INOX A4

L	L1	L2	B	S	D
A 41mm	35mm	18mm	28mm	3mm	5mm
B 56mm	47,5mm	18,5mm	35mm	3mm	5mm
C 80mm	71mm	24mm	50mm	4mm	5mm

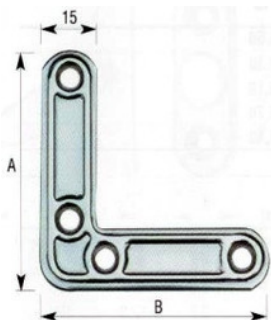
**Γωνίες πλακέ ART153** INOX A2

A	B
40mm	40mm
50mm	50mm
60mm	60mm
70mm	70mm

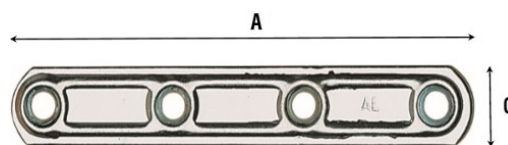
**Γωνίες πλακέ ART163** INOX A2

A	B
61mm	15mm
79mm	15mm
99mm	15mm
119mm	15mm
139mm	15mm

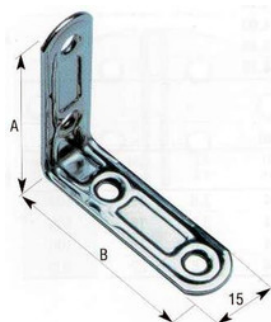
**Γωνίες ART164** INOX A2

A	B
31mm	31mm
40mm	40mm
50mm	50mm
60mm	60mm
70mm	70mm

**Λάμες πλακέ ενισχυμένες ART778** INOX A2

Πάχος: 2,5mm

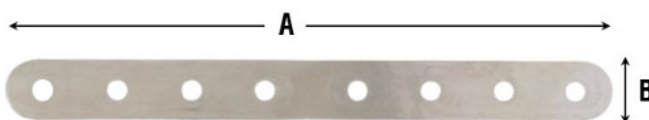

A	B
100mm	20mm
206mm	20mm

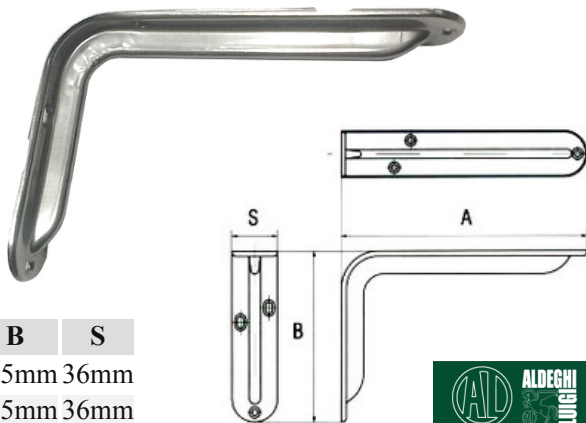
**Γωνίες ραφιών με νεύρο ART2522** INOX A2

A	B	S
195mm	135mm	36mm
245mm	165mm	36mm

**Χειρολαβές Ø19** INOX 18/8

Κωδικός	Μήκος
6170	150mm
6171	200mm
6172	250mm
6173	300mm



## Στηρίγματα τζαμιών ίσια

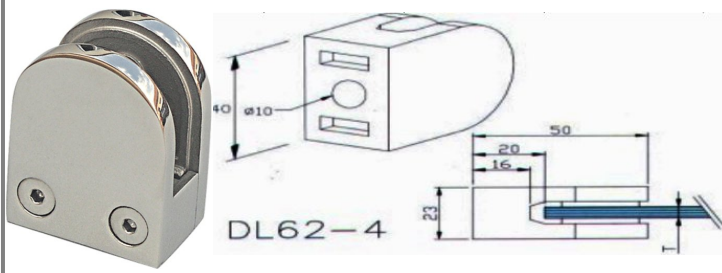

Κωδικός	Τύπος
DL62-4	Σατινέ INOX 304
DL62-4	Σατινέ INOX 316
DL62-4	Γυαλιστερό INOX 316



## Στηρίγματα τζαμιών κούρμπα

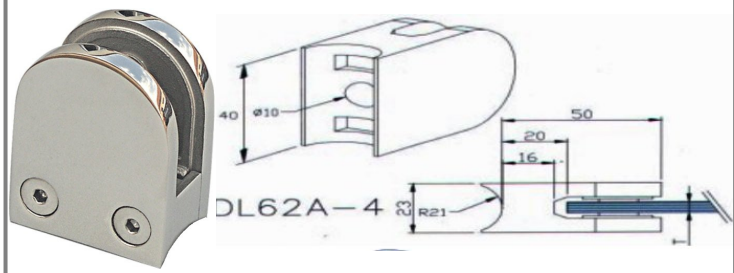

Κωδικός	Τύπος
DL62A-4	Σατινέ INOX 316
DL62A-4	Γυαλιστερό INOX 316



## Στηρίγματα τζαμιών ίσια

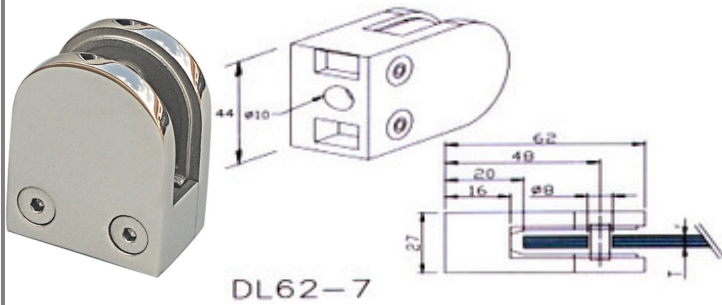

Κωδικός	Τύπος
DL62-7	Σατινέ INOX 304
DL62-7	Γυαλιστερό INOX 316



## Στηρίγματα τζαμιών κούρμπα

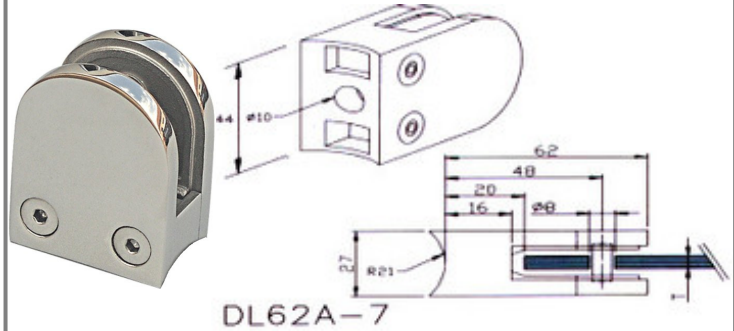

Κωδικός	Τύπος
DL62A-7	Σατινέ INOX 304
DL62A-7	Γυαλιστερό INOX 316



## Στοπ πόρτας πατητό INOX A4



Κωδικός	Τύπος
AKA350-SB01	140mm



## Στοπ πόρτας επιτοίχιο INOX A4

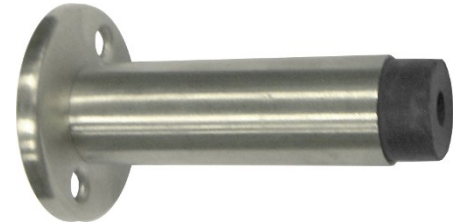

Κωδικός	Τύπος
AKA350-MP70	3/4"



## Στοπ πόρτας με λάστιχο INOX A4

Περιλαμβάνει βύσμα μετου



Κωδικός	Κορμός	Μήκος	Διάμετρος
AKA384-9	29mm	40mm	35mm



## Στοπ πόρτας με φαρδύ λάστιχο INOX A4

Περιλαμβάνει βύσμα μετου



Κωδικός	Κορμός	Μήκος	Διάμετρος
AKA384-10	29mm	40mm	45mm





## Ναυτικά κλειδιά "D" λάμας M8293 INOX A4

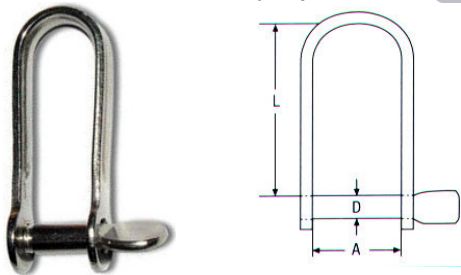

D	A	L
4mm	10mm	15mm
5mm	12mm	18mm
6mm	15mm	25mm

## Σύνδεσμοι αλυσίδας M8308 INOX A4

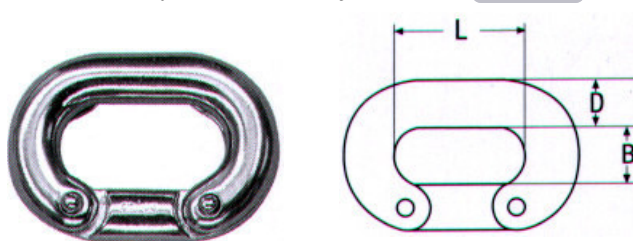

D	B	L
6mm	9mm	17,5mm
8mm	13mm	21mm
10mm	13mm	24mm

## Ναυτικά κλειδιά "D" με βίδα άλλεν M8261 INOX A4



D	A	L
6mm	12mm	21mm
8mm	16mm	28mm
10mm	20mm	35mm
12mm	24mm	42mm

## Ναυτικά κλειδιά "D" φαρδιά M8269 INOX A4

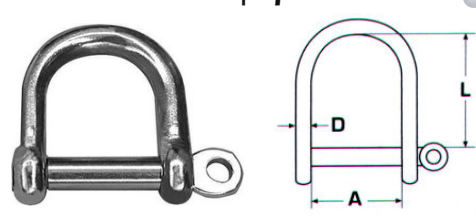

D	B	L
5mm	25mm	20mm
6mm	24mm	33mm
8mm	28mm	32mm
10mm	40mm	55mm

## Σύνδεσμοι αλυσίδας M8253 INOX A4

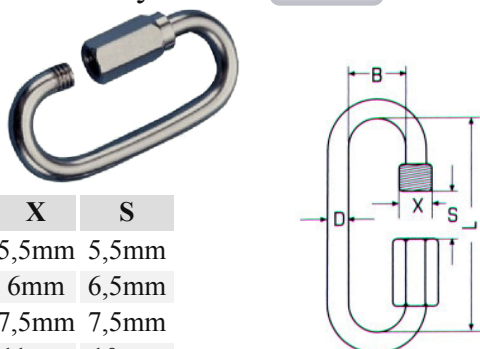

D	L	B	X	S
4mm	32mm	12mm	5,5mm	5,5mm
5mm	39mm	13mm	6mm	6,5mm
6mm	45mm	14mm	7,5mm	7,5mm
8mm	58mm	17mm	11mm	10mm
10mm	69mm	21mm	12mm	12mm
12mm	81mm	24mm	16mm	14,5mm

## Ναυτικά κλειδιά "D" M8358 INOX A4

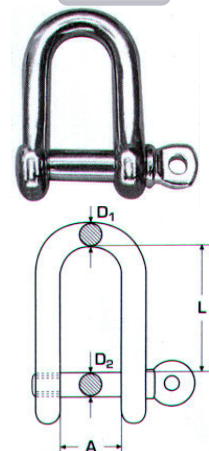

D	A	L	BL
4mm	8mm	14mm	6kN
5mm	10mm	17mm	8kN
6mm	12mm	21mm	12kN
8mm	16mm	28mm	28kN
10mm	20mm	35mm	40kN
12mm	24mm	42mm	48kN

## Ναυτικά κλειδιά "D" M8258 INOX A4

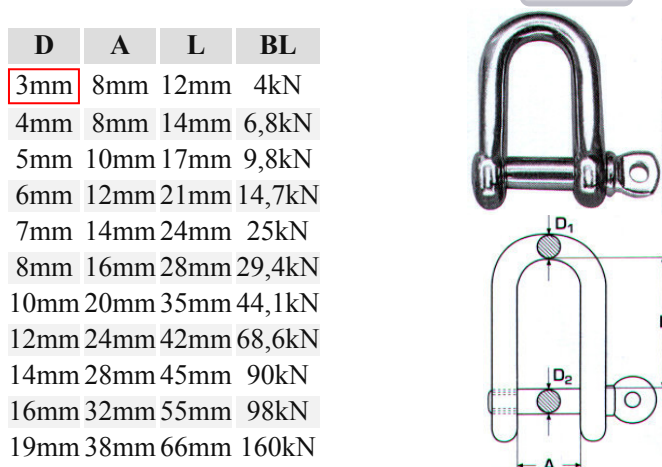

D	A	L	BL
3mm	8mm	12mm	4kN
4mm	8mm	14mm	6,8kN
5mm	10mm	17mm	9,8kN
6mm	12mm	21mm	14,7kN
7mm	14mm	24mm	25kN
8mm	16mm	28mm	29,4kN
10mm	20mm	35mm	44,1kN
12mm	24mm	42mm	68,6kN
14mm	28mm	45mm	90kN
16mm	32mm	55mm	98kN
19mm	38mm	66mm	160kN

## Ναυτικά κλειδιά "Ω" M8260 INOX A4

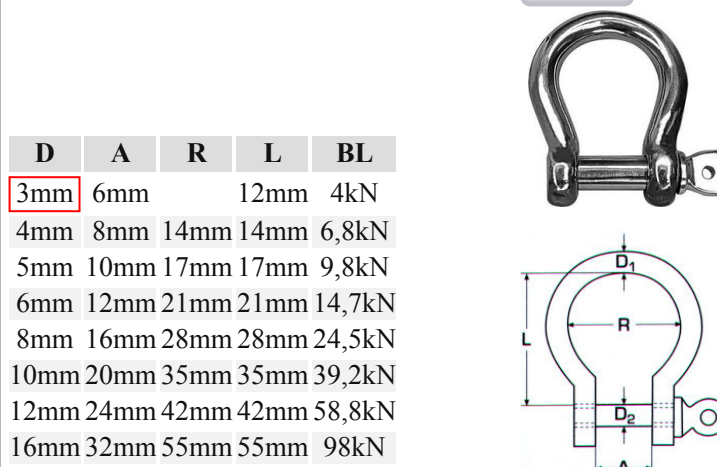

D	A	R	L	BL
3mm	6mm	12mm	4kN	
4mm	8mm	14mm	6,8kN	
5mm	10mm	17mm	9,8kN	
6mm	12mm	21mm	14,7kN	
8mm	16mm	28mm	24,5kN	
10mm	20mm	35mm	39,2kN	
12mm	24mm	42mm	58,8kN	
16mm	32mm	55mm	98kN	

**Ναυτικά κλειδιά μακρὰ "D" M8259** INOX A4

D	A	L	BL
4mm	8mm	32mm	6,8kN
5mm	10mm	37mm	8kN
6mm	12mm	45mm	12kN
8mm	16mm	60mm	20kN
10mm	20mm	75mm	40kN
12mm	24mm	42mm	48kN

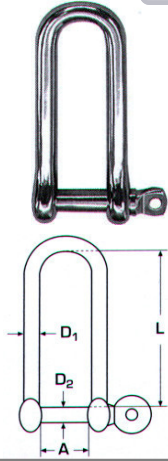
**Σύνδεσμοι αλυσίδας στραβοί M8288** INOX A4

D	A	L	SWL
4mm	8mm	23mm	6,5kN
5mm	10mm	27mm	9,8kN
6mm	12mm	33mm	14,7kN
8mm	16mm	44mm	24,5kN
10mm	20mm	55mm	44,1kN
12mm	24mm	66mm	68,6kN

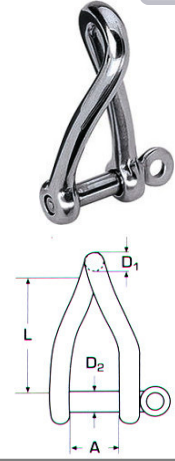
**Ναυτικά κλειδιά χειρασφαλείας M8359** INOX A4

D	A	L
5mm	12mm	38mm
6mm	15mm	45mm
8mm	20mm	60mm

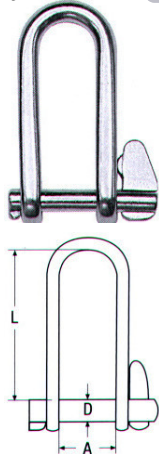
**Ναυτικά κλειδιά χειρασφαλείας με θηλιά M8360**

INOX A4

D	A	L	L1
5mm	12mm	38mm	12mm
6mm	15mm	45mm	15mm
8mm	20mm	60mm	20mm

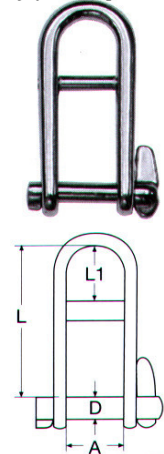

**Συρματόσχοινα INOX A4**

**Πάχος**

- 2,0
- 2,5
- 3,0
- 4,0
- 5,0
- 6,0
- 8,0
- 10,0



**Ροδάντζες συρματόσχοινου M8247 INOX A4**

Ø	A	B	E
2mm	7mm	10mm	2mm
2,5mm	8mm	14mm	2,5mm
3mm	10mm	17mm	3mm
4mm	11mm	18mm	4mm
5mm	13mm	20mm	5,6mm
6mm	15mm	25mm	6,5mm
8mm	18mm	33mm	9mm
10mm	23mm	41mm	11mm
12mm	27mm	48mm	14mm

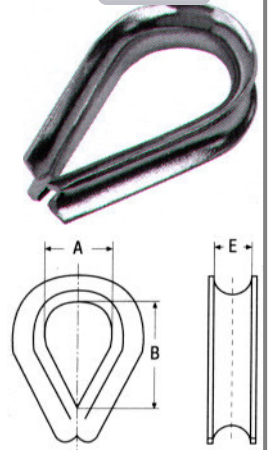

**Σφυγκτήρες συρματόσχοινου M8248 INOX A4**

D1	D2	B	L
2mm	3mm	16mm	10mm
3mm	4mm	21mm	12mm
4mm	4mm	22mm	12mm
5mm	5mm	23mm	13mm
6mm	5mm	26mm	15mm
8mm	6mm	30mm	19mm
10mm	8mm	34mm	22mm
12mm	10mm	40mm	30mm

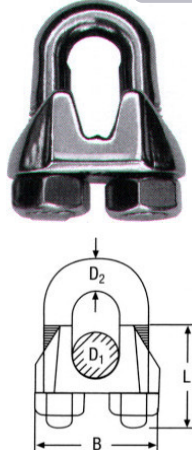

**Ταλουρίτ M8026 INOX A4**

D	A	L
2mm	2,3mm	9,3mm
3mm	3,3mm	11mm
4mm	4,4mm	14mm
5mm	5,5mm	18mm
6mm	6,6mm	21mm
8mm	8,8mm	28mm

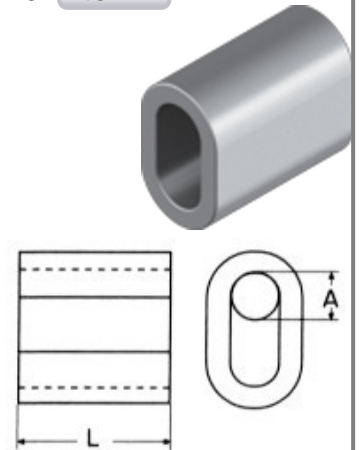

**Σφυγκτήρες μονοί M8330 INOX A4**

Ø	B1	D	H2	L
2mm	12mm	M4	14mm	15mm
3mm	14mm	M4	13mm	18mm
4mm	18mm	M5	18mm	20mm
5mm	20mm	M5	17mm	25mm
6mm	24mm	M6	23mm	30mm
8mm	30mm	M8	30mm	36mm

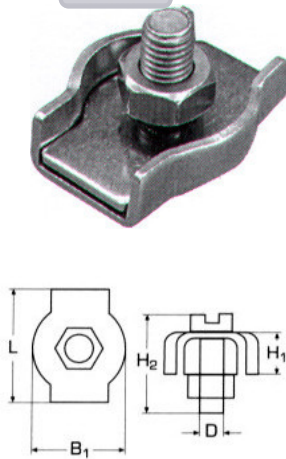

**Σφυγκτήρες διπλοί M8331 INOX A4**

Ø	B1	D	H2	L
2mm	12mm	M4	14mm	30mm
3mm	14mm	M4	13mm	36mm
4mm	18mm	M5	18mm	40mm
5mm	20mm	M5	17mm	50mm
6mm	24mm	M6	23mm	60mm
8mm	30mm	M8	30mm	72mm

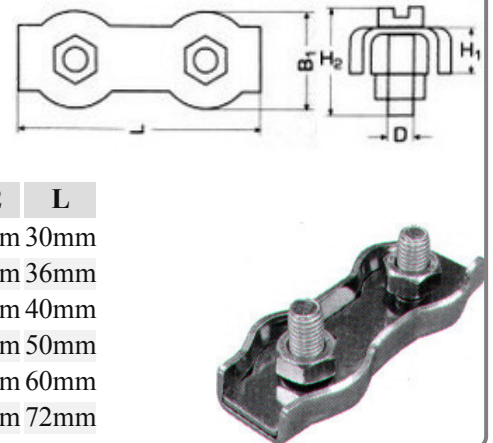

**Στοπ συρματόσχοινου M8427 INOX A4**

Ø	D	A	M
2mm	10mm	8mm	M4
3mm	15mm	12mm	M8
4mm	15mm	12mm	M8
5mm	20mm	15mm	M10
6mm	20mm	15mm	M10

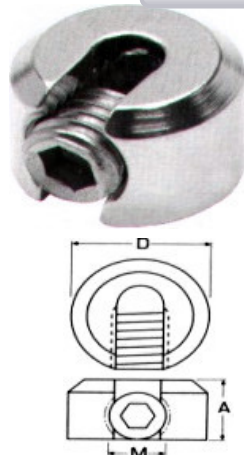

**Στοπ συρματόσχοινου M8426 INOX A4**

Ø	D	A
2mm	16mm	10mm
3mm	16mm	10mm
4mm	16mm	10mm
5mm	20mm	10mm

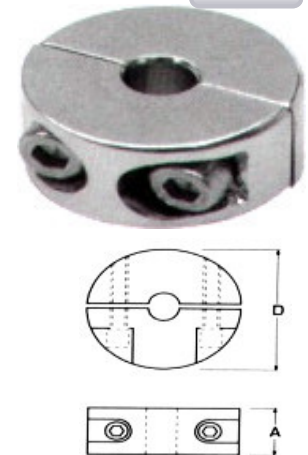

## Συνδετήρες κόμβου M8424 INOX A4



Ø	D	A	M
2mm	10mm	8mm	M4
3mm	15mm	12mm	M8
4mm	15mm	12mm	M8
5mm	20mm	15mm	M10
6mm	20mm	15mm	M10

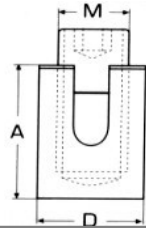

## Συνδετήρες κόμβου M8425 INOX A4



Ø	D	A	M
3mm	17mm	19mm	M10
4mm	20mm	21mm	M12
5mm	20mm	23mm	M12

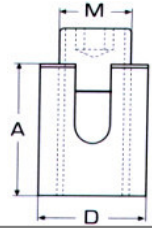

## Άκρα συρματόσχοινο M8322 INOX A4

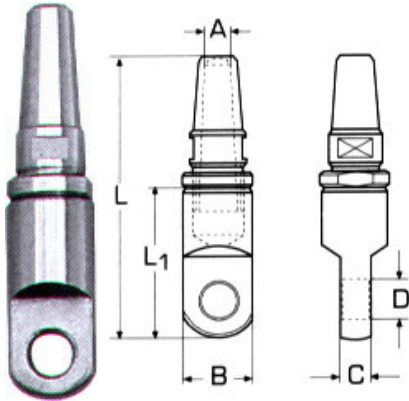

Ø	A	B	C	D	L	L1
4mm	4,5mm	18mm	7mm	8mm	71mm	40mm
5mm	6mm	20mm	9mm	10mm	91mm	45mm
6mm	7mm	24mm	10mm	13mm	98mm	55mm
8mm	9mm	30mm	13mm	15mm	121mm	69mm
10mm	11mm	36mm	13mm	15mm	152mm	80mm

## Άκρα συρματόσχοινο M8324 INOX A4

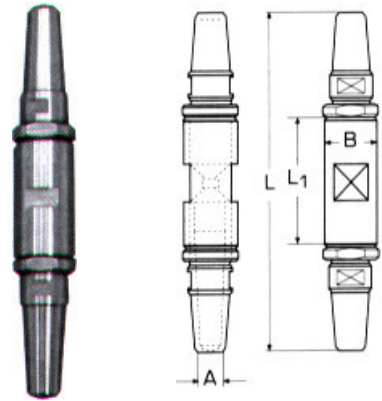

Ø	A	B	L	L1
4mm	4,5mm	18mm	71mm	40mm
5mm	6mm	20mm	129mm	45mm
6mm	7mm	24mm	98mm	55mm
8mm	9mm	30mm	121mm	69mm
10mm	11mm	36mm	152mm	80mm

## Άκρα συρματόσχοινο M8323 INOX A4

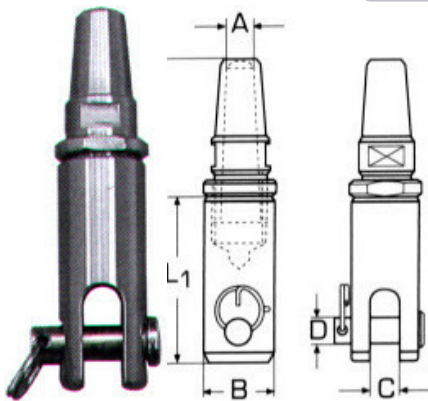

Ø	A	B	C	D	L	L1
4mm	4,5mm	18mm	8mm	6mm	76mm	45mm
5mm	6mm	20mm	10mm	8mm	98mm	52mm
6mm	7mm	24mm	11mm	10mm	106mm	63mm
8mm	9mm	30mm	14mm	10,5mm	134mm	82mm
10mm	11mm	36mm	14mm	12,5mm	166mm	94mm

## Άκρα συρματόσχοινο M8326 INOX A4

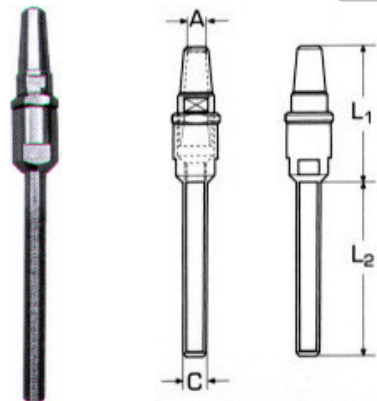

Ø	A	B	C	L2	L1
4mm	4,5mm	18mm	M8	75mm	54mm
5mm	6mm	20mm	M10	100mm	72mm
6mm	7mm	24mm	M12	125mm	75mm
8mm	9mm	30mm	M16	150mm	92mm
10mm	11mm	36mm	M16	150mm	117mm

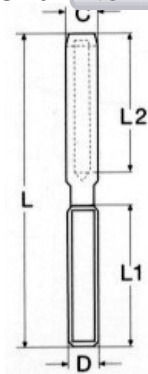
**Άκρα πρέσσας M8320 INOX A4**

Ø	D	L	L1	L2	C
2mm	M4	73mm	38mm	24mm	4,8mm
2,5mm	M5	86mm	40mm	32mm	5,5mm
3mm	M5	80mm	40mm	32mm	6,3mm
3mm	M6	100mm	48mm	39mm	6,5mm
4mm	M6	110mm	48mm	45mm	7,5mm
4mm	M8	117mm	57mm	45mm	7,5mm
5mm	M8	128mm	57mm	51mm	9,1mm
5mm	M10	130mm	63mm	52mm	9mm
6mm	M12	162mm	80mm	64mm	12,5mm
8mm	M16	200mm	100mm	80mm	16mm
10mm	M20	230mm	119mm	90mm	18mm
12mm	M20	245mm	120mm	105mm	20mm

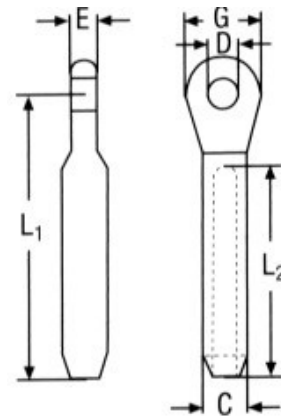
**Άκρα πρέσσας M8317 INOX A4**

Ø	L1	L2	E	D	C
2,5mm	50mm	30mm	3mm	5,4mm	5,5mm
3mm	55mm	36mm	4mm	6,5mm	6,3mm
4mm	65mm	39mm	6mm	8,5mm	7,5mm
5mm	80mm	50mm	7mm	10mm	9mm
6mm	94mm	62mm	8mm	12,5mm	12,5mm
8mm	124mm	85mm	10mm	14,5mm	16mm
10mm	142mm	90mm	12mm	16,4mm	18mm
12mm	160mm	105mm	16mm	19,3mm	20mm

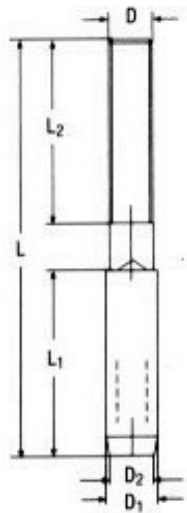
**Άκρα πρέσσας M8447 INOX A4**

Ø	D	D1	D2	L	L1	L2
4mm	M6	7,5mm	4,3mm	90mm	25mm	60mm
5mm	M8	9mm	5,3mm	100mm	31mm	60mm
6mm	M10	12,5mm	6,3mm	125mm	37mm	80mm

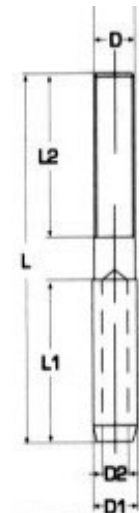
**Άκρα πρέσσας M8445 INOX A4**

Ø	D	D1	D2	L	L1	L2
4mm	M6	7,5mm	4,3mm	90mm	25mm	25mm
5mm	M8	9mm	5,3mm	100mm	31mm	31mm
6mm	M10	12,5mm	6,3mm	125mm	37mm	40mm

## Άκρα πρέσσας μηχανής M8316MT INOX A4

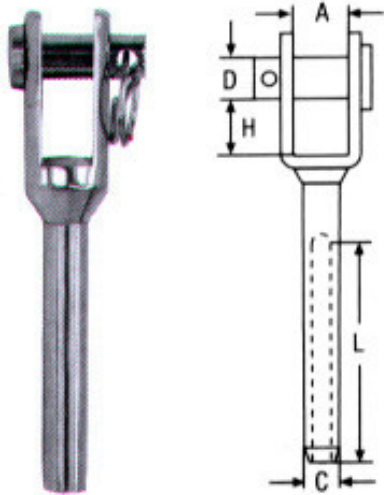

Ø	D	A	L	C	H
3mm	6mm	6,3mm	39mm	6,5mm	11mm
4mm	8mm	8mm	45mm	8mm	14mm
5mm	9mm	10mm	52mm	9mm	20mm
6mm	12mm	11mm	64mm	13mm	22mm
8mm	14mm	14mm	80mm	16mm	26mm

## Άκρα πρέσσας κολλητά M8316 INOX A4

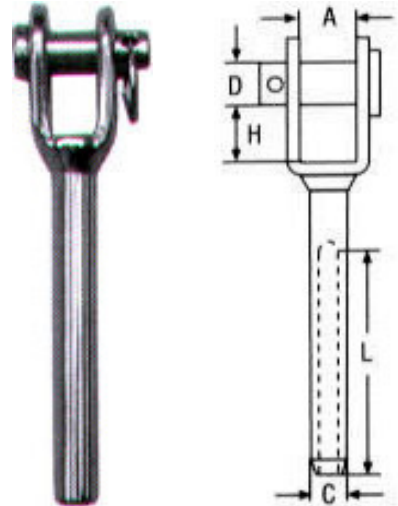

Ø	D	A	L	C	H
3mm	6mm	7,5mm	32mm	6,5mm	10mm
4mm	8mm	11mm	40mm	7,5mm	11mm
5mm	9mm	12mm	57mm	9mm	14mm
6mm	12mm	14mm	63mm	12,5mm	20mm
8mm	14mm	17mm	85mm	16mm	26mm

## Άκρα πρέσσας δεξιόστροφα M8552 INOX A4

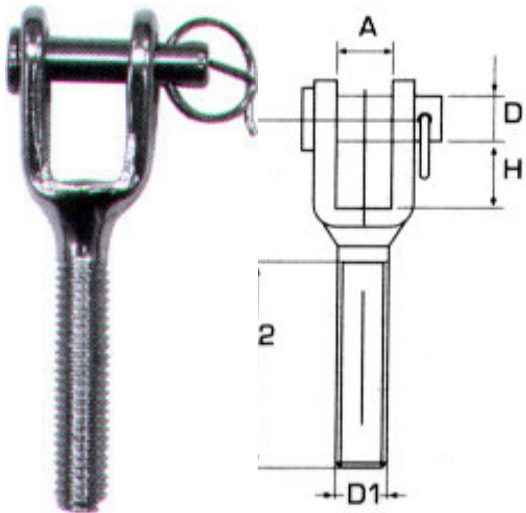

D1	L1	L2	H	A	D
M6	47mm	25mm	10mm	8mm	6mm
M8	52mm	25mm	12mm	10mm	8mm
M10	72mm	45mm	14mm	12mm	10mm

## Άκρα πρέσσας αριστερόστροφα M8553 INOX A4

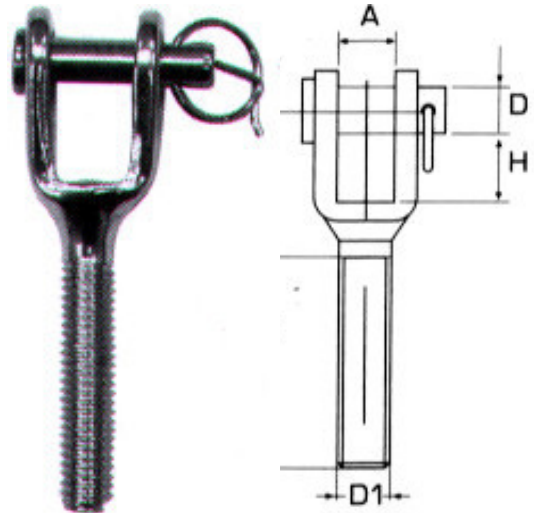

D1	L1	L2	H	A	D
M6	47mm	25mm	10mm	8mm	6mm
M8	52mm	25mm	12mm	10mm	8mm
M10	72mm	45mm	14mm	12mm	10mm

**Άκρα πρέσσας με εσωτερικό δεξί πάσο M8455**

INOX A4

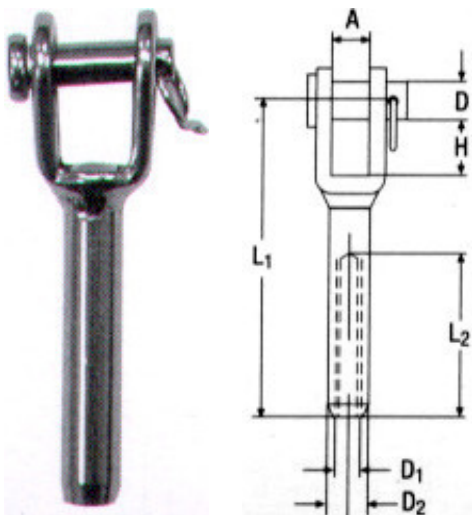

D1	L1	L2	A	D	H	D2
M6	60mm	30mm	9mm	6mm	10mm	8mm
M8	65mm	31mm	10mm	8mm	12mm	12mm
M10	70mm	40mm	12mm	10mm	12mm	14mm

**Άκρα πρέσσας με εσωτερικό αριστερό πάσο M8456**

INOX A4

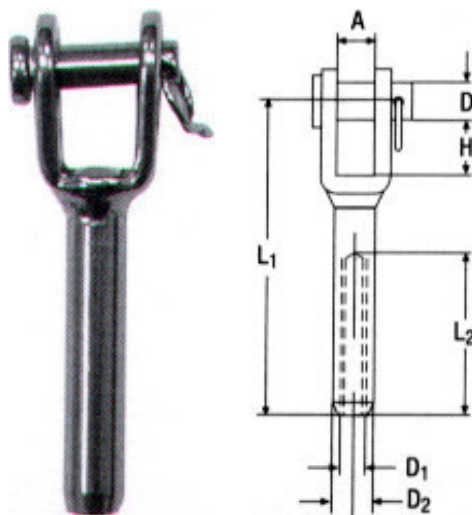

D1	L1	L2	A	D	H	D2
M6	60mm	30mm	9mm	6mm	10mm	8mm
M8	65mm	31mm	10mm	8mm	12mm	12mm
M10	70mm	40mm	12mm	10mm	12mm	14mm

**Εντατήρες συρματόσχοινων κολλητοί M8245**

INOX A4

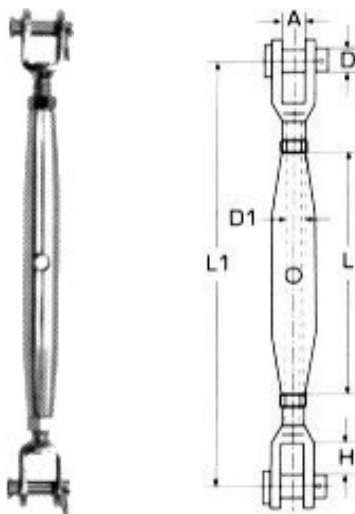

D1	L	L1	A	D	H
M5	80mm	130mm	6,5mm	5mm	10mm
M6	95mm	150mm	7,5mm	6mm	10mm
M8	105mm	165mm	11mm	8mm	11mm
M10	125mm	190mm	12mm	9mm	14mm
M12	150mm	245mm	14mm	12mm	20mm
M14	165mm	270mm	15mm	12mm	22mm
M16	190mm	310mm	17mm	16mm	26mm

**Εντατήρες συρματόσχοινων μασίφ M8245T**

INOX A4

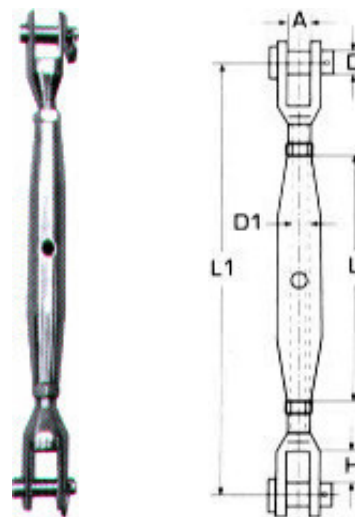

D1	L	L1	A	D	H
M5	70mm	130mm	6,5mm	5mm	10mm
M6	80mm	155mm	7,5mm	6mm	10mm
M8	90mm	180mm	11mm	8mm	11mm
M10	100mm	210mm	12mm	9mm	14mm
M12	140mm	270mm	14mm	12mm	20mm
M16	170mm	340mm	17mm	16mm	26mm

## Εντατήρες συρματόσχοινων με τερματικό M8275

INOX A4

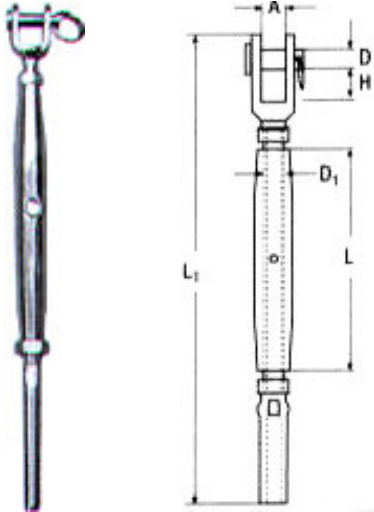

D1	Ø	L	L1	A	D	H
M6	3mm	95mm	175mm	7,5mm	6mm	10mm
M8	4mm	105mm	200mm	11mm	8mm	11mm
M10	5mm	125mm	230mm	12mm	9mm	14mm
M12	6mm	150mm	285mm	14mm	12mm	20mm
M16	8mm	190mm	360mm	17mm	16mm	26mm

## Εντατήρες συρματόσχοινων με τερματικό M8275MT

INOX A4

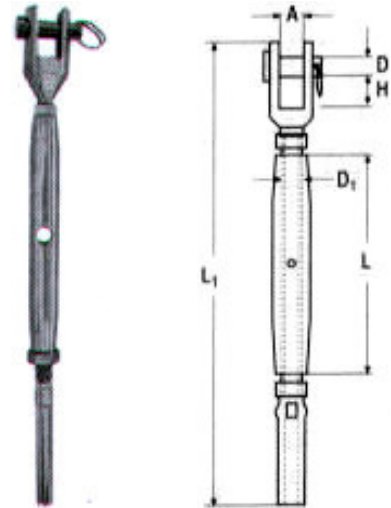

D1	Ø	L	L1	A	D	H
M6	3mm	95mm	175mm	7,5mm	6mm	10mm
M8	4mm	105mm	200mm	11mm	8mm	11mm
M10	5mm	125mm	230mm	12mm	9mm	14mm
M12	6mm	150mm	285mm	14mm	12mm	20mm
M16	8mm	190mm	360mm	17mm	16mm	26mm

## Εντατήρες συρματόσχοινων με σπαστή κεφαλή M8476

INOX A4

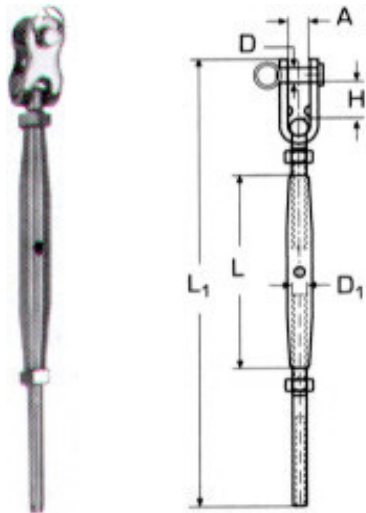

D1	Ø	L	L1	A	D	H	Τιμή
M6	3mm	95mm	175mm	7,5mm	6mm	15mm	
M8	4mm	105mm	200mm	11mm	8mm	20mm	
M10	5mm	125mm	230mm	12mm	9mm	25mm	
M12	6mm	150mm	285mm	14mm	12mm	30mm	
M16	8mm	190mm	360mm	17mm	16mm	40mm	
M20	10mm	210mm	450mm	20mm	19mm	45mm	

## Εντατήρες συρματόσχοινων με θηλιές M8246A

INOX A4

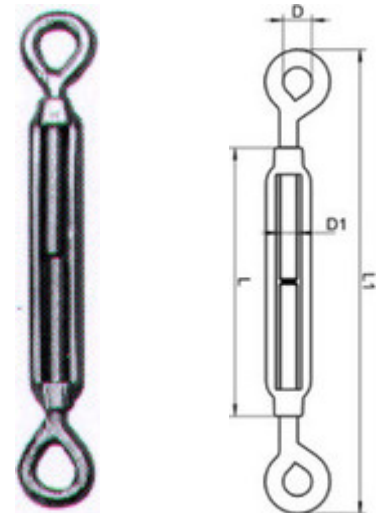

D1	L	L1	D	Τιμή
M5	70mm	120mm	8mm	
M6	90mm	150mm	10mm	
M8	120mm	200mm	14mm	
M10	150mm	240mm	16mm	
M12	200mm	310mm	18mm	
M16	250mm	390mm	26mm	
M20	300mm	440mm	30mm	



## Εντατήρες συρματόσχοινων με γάντζους M8246B

INOX A4

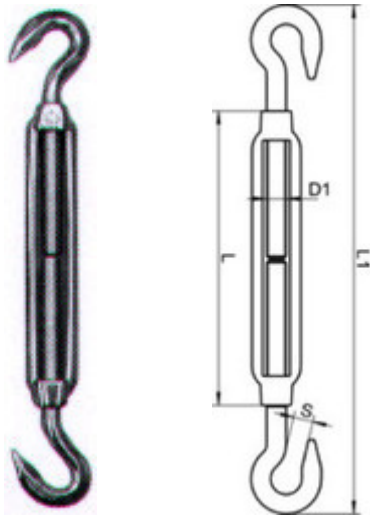

D1	L	L1	D	S	Τιμή
----	---	----	---	---	------

M5	70mm	120mm	8mm	8mm	
M6	90mm	150mm	10mm	9mm	
M8	120mm	200mm	14mm	11mm	
M10	150mm	240mm	16mm	12mm	
M12	200mm	310mm	18mm	14mm	
M16	250mm	390mm	26mm	16mm	
M20	300mm	440mm	30mm	18mm	

## Εντατήρες συρματόσχοινων με γάντζο - θηλιά

M8246C INOX A4

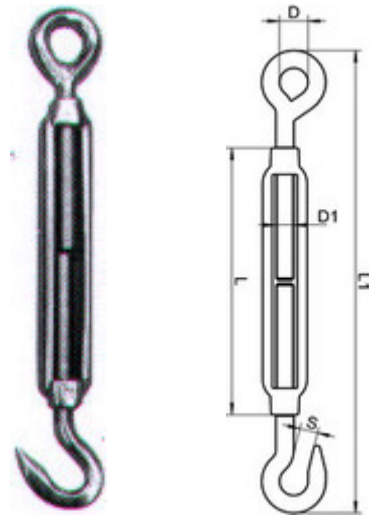

D1	L	L1	D	S	Τιμή
----	---	----	---	---	------

M5	70mm	120mm	8mm	8mm	
M6	90mm	150mm	10mm	9mm	
M8	120mm	200mm	14mm	11mm	
M10	150mm	240mm	16mm	12mm	
M12	200mm	310mm	18mm	14mm	
M16	250mm	390mm	26mm	16mm	
M20	300mm	440mm	30mm	18mm	

## Κλειδιά γενικής χρήσης M8306 INOX A4



B	L
---	---

???	87mm
-----	------

**Γάντζοι αλυσίδας M8388 INOX A4**

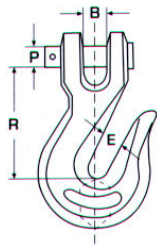

Ø	B	E	P	R
6	11mm	9mm	9mm	46mm
8	13mm	11mm	11mm	54mm
10	15mm	12mm	12mm	58mm

**Γάντζοι με πύρο M8334 INOX A4**

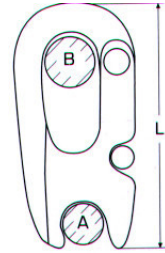

L	A	B
52mm	12mm	10mm
66mm	15mm	14mm
96mm	20mm	18mm

**Γάντζοι με πύρο M8263 INOX A4**

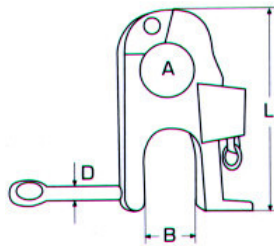
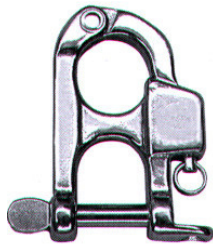

D	A	B	L
5mm	15mm	16mm	60mm

**Γάντζοι με πύρο και στριφτάρι M8252 INOX A4**

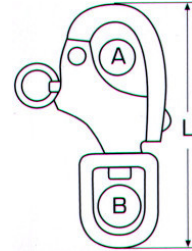

L	A	B
68mm	12mm	12mm
87mm	16mm	14mm
128mm	22mm	22mm

**Γάντζοι με πύρο, στριφτάρι και ναυτικό κλειδί M8262 INOX A4**

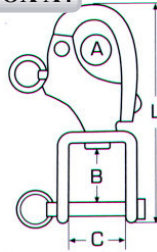

L	A	B	C
70mm	12mm	12mm	12mm
87mm	16mm	13mm	13mm
128mm	22mm	16mm	19mm

**Γάντζοι με πύρο και θηλιά M8297 INOX A4**

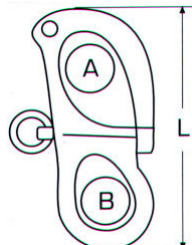

L	A	B
52mm	12mm	9mm
66mm	16mm	12mm
96mm	22mm	16mm

**Στριφτάρια μάτι - μάτι M8254 INOX A4**

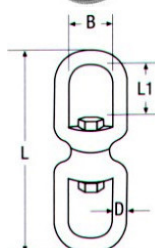

D	L	L1	B
5mm			
6mm	65mm	15mm	15mm
8mm	90mm	22mm	20mm
10mm	115mm	27mm	24mm
13mm	154mm	35mm	32mm
16mm	168mm	45mm	39mm

**Στριφτάρια μάτι - ναυτικό M8255 INOX A4**

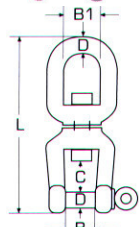

D	L	B	C	B1
6mm	66mm	12mm	11mm	15mm
8mm	92mm	16mm	16mm	20mm
10mm	118mm	20mm	22mm	24mm
13mm	152mm	26mm	28mm	32mm
16mm	188mm	32mm	37mm	39mm
19mm	229mm	38mm	45mm	42mm

## Στριφτάρια ναυτικό - ναυτικό M8256 INOX A4

D	L	B	C
6mm	66mm	12mm	12mm
8mm	94mm	16mm	16mm
10mm	118mm	20mm	22mm
13mm	152mm	26mm	28mm
16mm	188mm	32mm	37mm
19mm	229mm	38mm	44mm

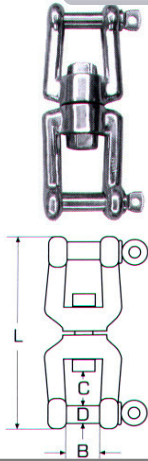

## Γάντζοι πυροσβεστικοί M8249 INOX A4

D	L	A	E
4mm	40mm	5mm	6mm
5mm	50mm	6mm	7mm
6mm	60mm	7mm	8mm
7mm	70mm	10mm	9mm
8mm	80mm	12mm	10mm
10mm	100mm	15mm	12mm
11mm	120mm	18mm	16mm
12mm	140mm	20mm	19mm

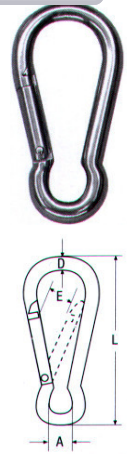

## Γάντζοι πυροσβεστικοί με θηλιά M8250 INOX A4

D	L	A	E
4mm	40mm	5mm	6mm
5mm	50mm	6mm	7mm
6mm	60mm	7mm	8mm
7mm	70mm	9mm	8mm
8mm	80mm	10mm	9mm
10mm	100mm	13mm	12mm
11mm	120mm	15mm	16mm
12mm	140mm	18mm	19mm

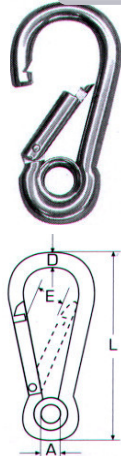

## Γάντζοι πυροσβεστικοί με πλάγιο άνοιγμα M8010 INOX A4

D	L	A	E
8mm	80mm	12mm	19mm
10mm	100mm	15mm	22mm
11mm	120mm	18mm	26mm

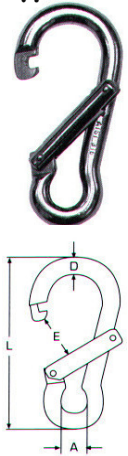

## Πυροσβεστικοί γάντζοι με παξιμάδι M8004 INOX A4

D	L	A	E
6mm	60mm	9mm	8mm
8mm	80mm	12mm	9mm
10mm	100mm	15mm	12mm
11mm	120mm	18mm	16mm

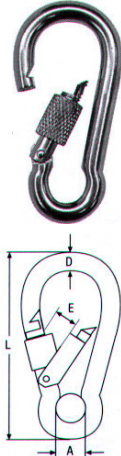

## Πυροσβεστικοί γάντζοι με παξιμάδι και θηλιά M8005 INOX A4

D	L	A	E
6mm	60mm	9mm	8mm
8mm	80mm	12mm	9mm
10mm	100mm	13mm	12mm
11mm	120mm	15mm	16mm

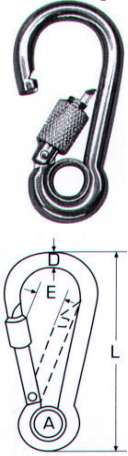

## Πυροσβεστικοί γάντζοι αχλάδι M8054 INOX A4

D	L	A	E
6mm			
8mm	80mm	12mm	13mm
10mm	100mm	15mm	18mm
11mm	120mm	18mm	24mm

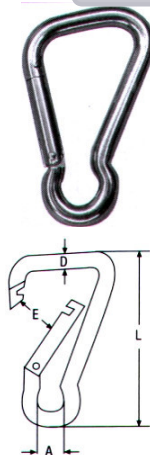

## Πυροσβεστικοί γάντζοι αχλάδι με θηλιά M8055 INOX A4

D	L	A	E
6mm	60mm	10mm	7,5mm
8mm	80mm	13mm	10mm
10mm	100mm	18mm	13mm
11mm	120mm	24mm	15mm

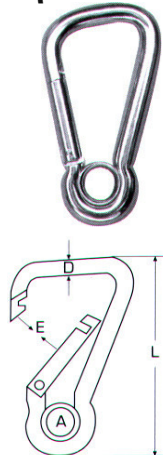

**Πυροσβεστικοί γάντζοι διπλή ασφάλεια & θηλιά M8338 INOX A4**

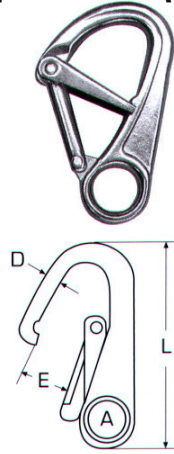

D	L	A	E
1mm	110mm	20mm	20mm

**Πυροσβεστικοί γάντζοι γαμψοί M8251 INOX A4**

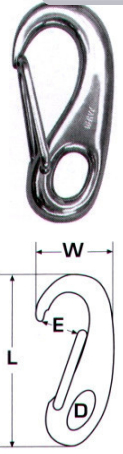

L	W	E	D
50mm	24mm	10mm	6,5mm
70mm	31mm	13mm	10mm
100mm	46mm	23mm	13mm

**Γάντζοι με θηλιά HL0604 INOX A4**



Πάχος θηλιάς	B	L	O
1/4"	13mm	91mm	22mm
5/16"	16mm	108mm	24mm
3/8"	18mm	124,5mm	28mm
1/2"	24mm	161mm	37mm

**Γάντζοι με στριφτάρι HL0605 INOX A4**



Πάχος θηλιάς	B	L	O
1/4"	22mm	119mm	22,5mm
5/16"	27,5mm	141,5mm	24mm
3/8"	28mm	160,5mm	28,5mm
1/2"	35,7mm	199,5mm	36mm

**Πυροσβεστικοί γάντζοι γαμψοί με νόχι M8153 INOX A4**

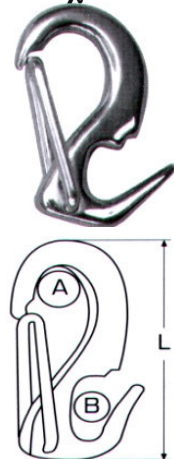

A	B	L
7,5mm	6,5mm	50mm
9mm	8mm	55mm
11mm	10mm	65mm

**Γάντζοι διπλοί M8416 INOX A4**

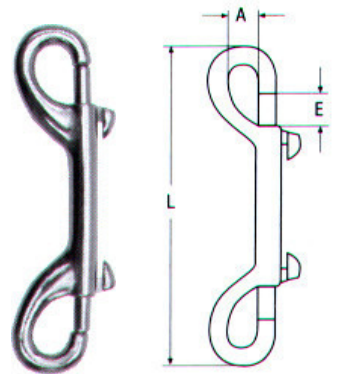

L	E	A
90mm	6mm	6mm
100mm	10mm	10mm
120mm	12mm	11mm

**Γάντζοι παγουριού με στριφτάρι M8257 INOX A4**



L	D	E	A
85mm	5mm	10mm	16mm
100mm	6mm	12mm	19mm
115mm	7mm	15mm	22mm

**Γάντζοι παγουριού με στριφτάρι M8303 INOX A4**

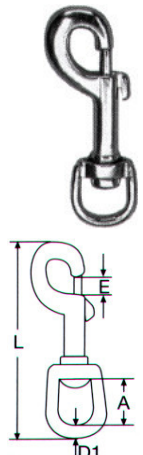

L	D1	E	A
62mm	3mm	7mm	10mm
75mm	4mm	8mm	13mm
87mm	5mm	9mm	16mm
90mm	5mm	10mm	19mm
120mm	6mm	14mm	33mm

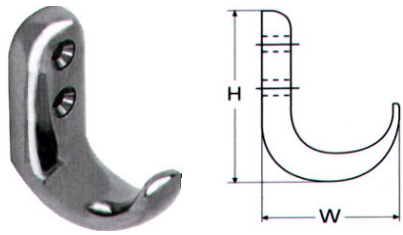
**Κρεμαστράκι M8399** INOX A4

W	H
40mm	31mm

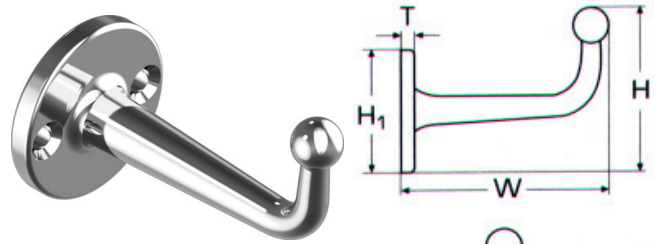
**Κρεμάστρες M8361** INOX A4

W	H	H1	T
A 47mm	37mm	28mm	3,5mm
B 68mm	45mm	36mm	5mm

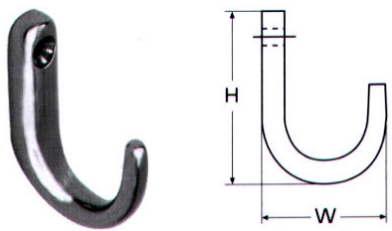
**Κρεμάστρες M8370** INOX A4

W	H
40mm	31mm

**Κρεμαστράκια Steyr M8375** INOX A4

H	L	W	F
A 24mm	38mm	34mm	8mm
B 34mm	40mm	34mm	14mm

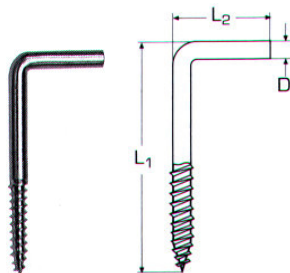
**Γωνίες βίδα M8707** INOX A4

D	L1	L2
3mm	30mm	10mm
3,5mm	40mm	10mm
4mm	45mm	15mm
4,5mm	50mm	20mm
5mm	60mm	20mm

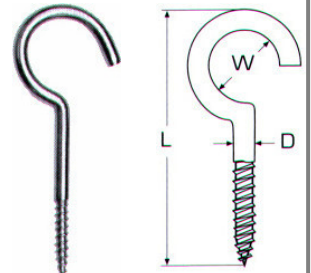
**Γάντζοι βίδα M8706** INOX A4

D	L	W
3,3mm	40mm	14mm
3,5mm	50mm	17mm
3,5mm	60mm	16mm
4,4mm	50mm	16mm
4,4mm	65mm	22mm
5,2mm	80mm	26mm
6mm	100mm	26mm

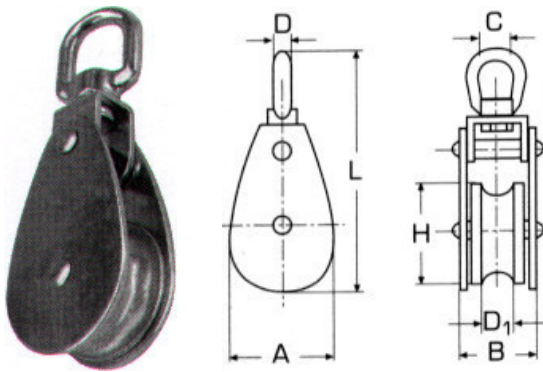
**Ράουλα M8369 INOX A4**

H	D1	L	C	D	A	B
---	----	---	---	---	---	---

A	25mm	10mm	88mm	13mm	5mm	27mm	24mm
---	------	------	------	------	-----	------	------

B	32mm	10mm	98mm	13mm	6mm	35mm	42mm
---	------	------	------	------	-----	------	------

C	50mm	14mm	142mm	20mm	8mm	54mm	54mm
---	------	------	-------	------	-----	------	------

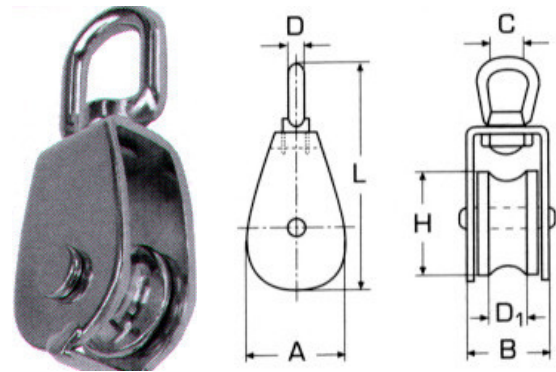
**Ράουλα M8393 INOX A4**

H	D1	L	C	D	A	B
---	----	---	---	---	---	---

A	25mm	12mm	83mm	15mm	6mm	30mm	24mm
---	------	------	------	------	-----	------	------

B	32mm	12mm	97mm	16mm	6mm	36mm	24mm
---	------	------	------	------	-----	------	------

C	50mm	15mm	127mm	20mm	8mm	54mm	28mm
---	------	------	-------	------	-----	------	------

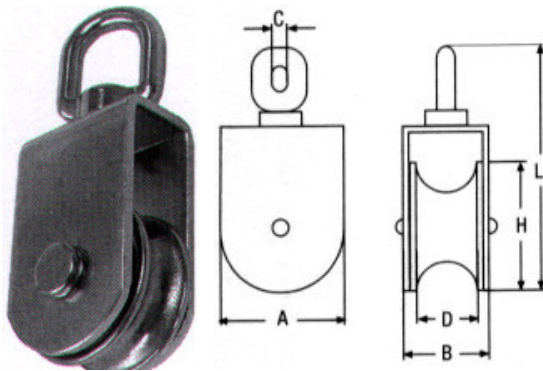
**Ράουλα M8392 INOX A4**

H	L	D	A
---	---	---	---

A	50mm	127mm	14mm	52mm
---	------	-------	------	------

B	75mm	170mm	15mm	78mm
---	------	-------	------	------

C	100mm	205mm	17,5mm	104mm
---	-------	-------	--------	-------

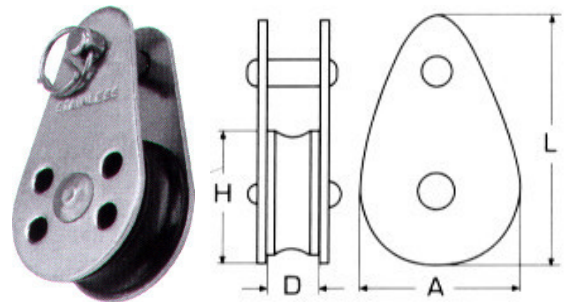
**Τροχαλίες με πλαστικό ράουλο M8389 INOX A4**

H	L	D	A
---	---	---	---

25mm	45mm	6,5mm	25mm
------	------	-------	------

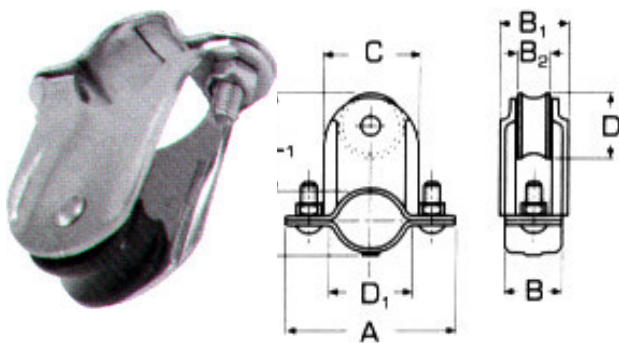
**Ράουλα σωλήνων μονά M8291 INOX A4**

D	B1	B2	B	D1	A	L	C
---	----	----	---	----	---	---	---

Ø24	25mm	14mm	20mm	25mm	62mm	80mm	36mm
-----	------	------	------	------	------	------	------

Ø24	25mm	14mm	20mm	25mm	62mm	80mm	36mm
-----	------	------	------	------	------	------	------

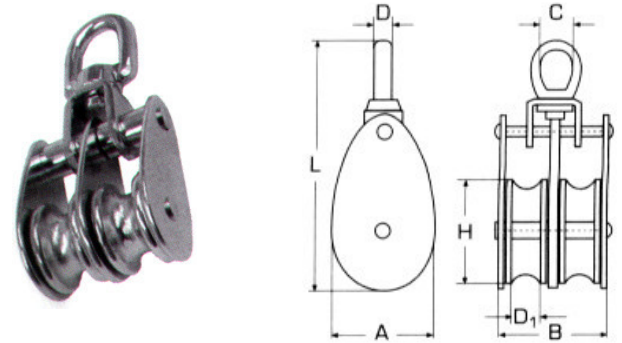
**Ράουλα διπλά M8390 INOX A4**

H	D1	L	C	D	A	B
---	----	---	---	---	---	---

A	25mm	10mm	88mm	13mm	5mm	27mm	37mm
---	------	------	------	------	-----	------	------

B	32mm	10mm	98mm	13mm	6mm	35mm	42mm
---	------	------	------	------	-----	------	------

C	50mm	14mm	142mm	20mm	8mm	54mm	54mm
---	------	------	-------	------	-----	------	------



**Χούφτες χυτές M8241 INOX A4**

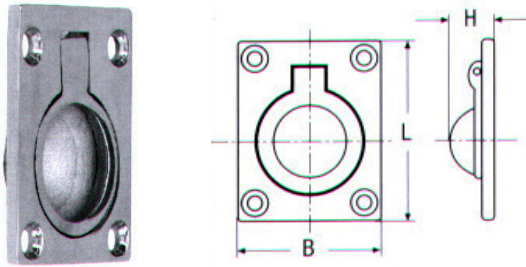

L	B	H
46mm	38mm	12mm

**Χούφτες αμπαριού M8118 INOX A4**

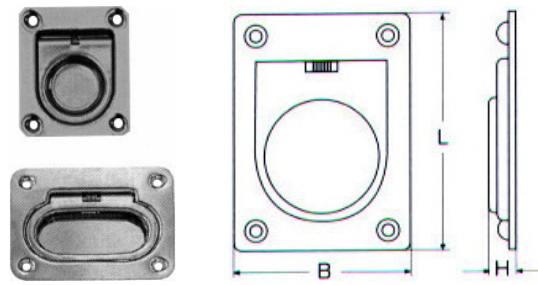

L	B	H
A 65mm	55mm	11mm
B 57mm	76mm	11mm

**Χούφτες χυτές στρόγγυλες M8441 INOX A4**

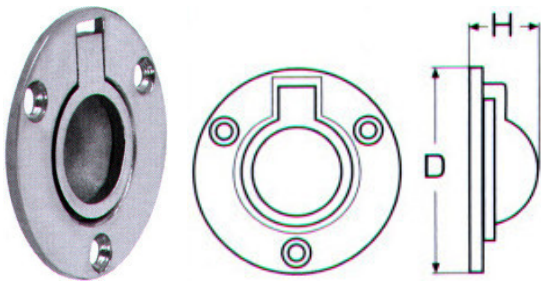

D	H
50mm	10mm

**Χούφτες χυτές M8242 INOX A4**

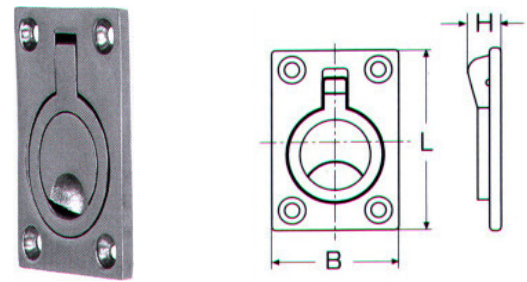

L	B	H
63mm	44mm	12mm

**Χούφτες χυτές M8243 INOX A4**

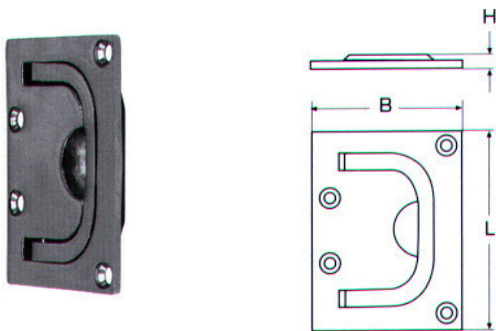

L	B	H
76mm	56mm	9mm

**Ωμέγα λάμας M8127 INOX A4**

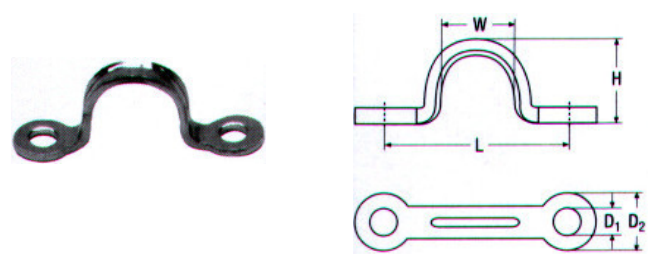

D1	D2	L	W	H
4,2mm	10mm	29mm	13mm	12mm
5mm	11mm	35mm	16mm	16mm
5,3mm	12mm	45mm	21mm	21mm

**Ωμέγα χυτά M8227 INOX A4**

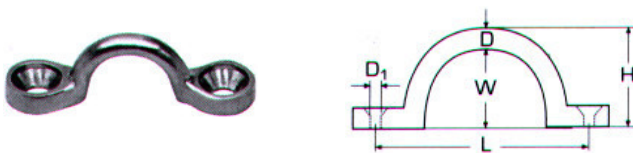

D	L	H	W	D1
5mm	34mm	15mm	10mm	5,3mm

**Ωμέγα χυτά M8226 INOX A4**

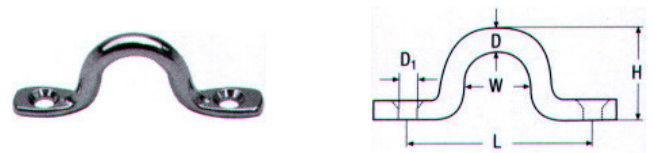

D	L	H	W	D1
5mm	38mm	18mm	16mm	4,2mm
6mm	48mm	22mm	20mm	5,2mm
8mm	49mm	24mm	20mm	5,6mm

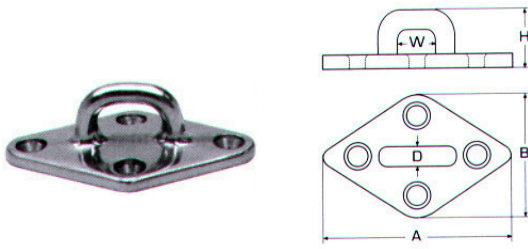
**Μάπα με πλάκα ρόμβο M8223** INOX A4

A	B	W	H	D
A 80mm	50mm	19mm	24mm	7,5mm
B 90mm	55mm	22mm	28mm	8mm
C 100mm	62mm	25mm	34mm	9mm

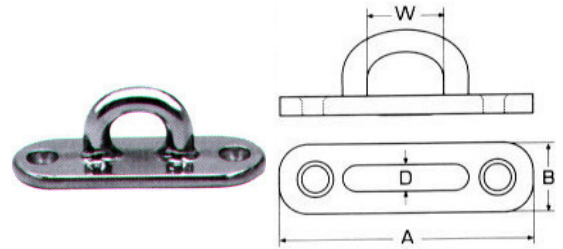
**Μάπα με πλάκα οβάλ M8224** INOX A4

A	B	W	D
A 75mm	22mm	16mm	7,5mm
B 88mm	32mm	19mm	8mm
C 100mm	36mm	22mm	9mm

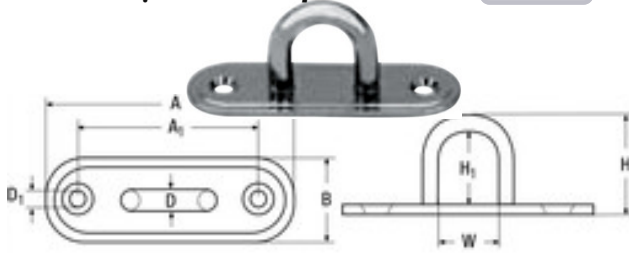
**Μάπα με πλάκα οβάλ M8266** INOX A4

A	B	D	A1	H	H1	W	D1
A 45mm	15mm	5mm	31mm	20mm	13mm	12mm	4mm
B 60mm	20mm	6mm	43mm	26mm	19mm	19mm	5mm
C 80mm	26mm	8mm	56mm	32mm	22mm	22mm	6mm
D 100mm	36mm	9mm	70mm	38mm	27mm	26mm	6,5mm

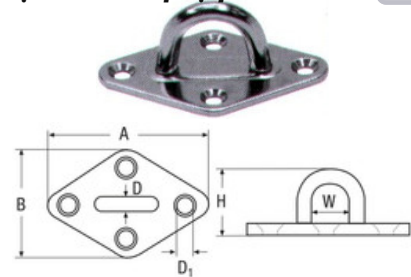
**Μάπα με πλάκα ρόμβο M8264** INOX A4

A	B	W	H	D	D1
A 59mm	37mm	11mm	22mm	5mm	4,2mm
B 64mm	40mm	15mm	27mm	6mm	4,2mm
C 80mm	50mm	18mm	32mm	8mm	5,5mm

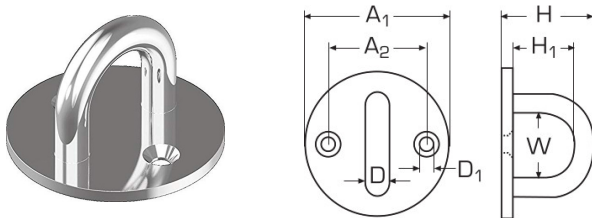
**Μάπα με στρόγγυλη πλάκα M8353** INOX A4

A1	A2	H	H1	W	D	D1
A 33mm	18mm	19mm	11mm	13mm	5mm	4,5mm
B 40mm	22mm	26mm	17mm	16mm	6mm	4,5mm
C 50mm	28mm	32mm	21mm	20mm	8mm	4,5mm

**Μάπες αρσενικές με κοντό σπείρωμα DIN580**

INOX A4

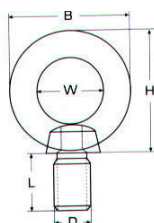

D	L	B	H	W
M6	10mm	28mm	28mm	17mm
M8	13mm	36mm	36mm	20mm
M10	17mm	45mm	45mm	25mm
M12	20,5mm	54mm	53mm	30mm
M16	27mm	63mm	62mm	35mm
M20	30mm	72mm	71mm	40mm

**Μάπες θηλυκές DIN582**

INOX A4

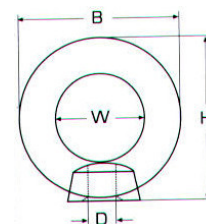

D	H	B	W
M6	27mm	27mm	16mm
M8	36mm	36mm	20mm
M10	45mm	45mm	25mm
M12	53mm	54mm	30mm
M16	63mm	62mm	35mm
M20	109mm	108mm	65mm

**Μάπες στριφώνι M8268**

INOX A4

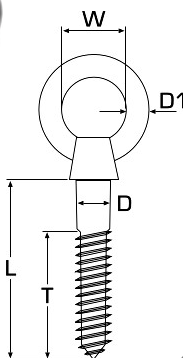

D	L1	T	D1	D2
5mm	50mm	30mm	5mm	11mm
6mm	60mm	35mm	5mm	14mm
8mm	80mm	50mm	6mm	18mm
10mm	100mm	60mm	8mm	22mm

**Μάπες αρσενικές M8267**

INOX A4

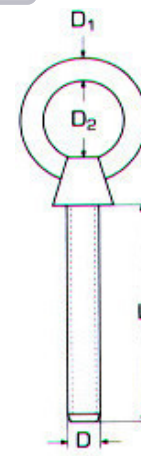

D	L1	D1	D2
M6	60mm	5mm	15mm
M6	80mm	5mm	15mm
M8	80mm	6mm	20mm
M8	100mm	6mm	20mm
M10	80mm	8mm	25mm
M10	100mm	8mm	25mm
M12	100mm	10mm	30mm
M12	120mm	10mm	30mm

**Μάπες αρσενικές με κρίκο M8228**

INOX A4

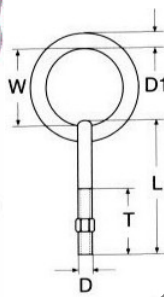

D	D1	L	T	W
M6	6mm	90mm	55mm	35mm
M8	8mm	100mm	60mm	45mm
M10	10mm	130mm	80mm	50mm
M12	12mm	150mm	90mm	60mm

**Βιδιοθηλιές M8705**

INOX A4

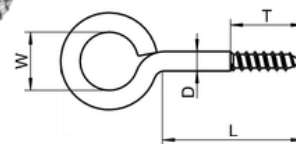

D	L	T	W
3,3mm	16mm	10mm	8mm
3,7mm	20mm	12mm	10mm
4mm	25mm	15mm	12mm
4,4mm	30mm	18mm	14mm

**U-bolts M8230**

INOX A4

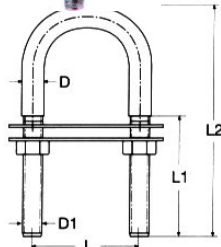

D1	L1	L2	D	L
M4	30mm	62mm	5mm	30mm
M5	48mm	78mm	6mm	36mm
M6	42mm	80mm	8mm	36mm
M8	40mm	90mm	10mm	35mm
M8	52mm	100mm	10mm	45mm
M10	35mm	90mm	12mm	50mm
M10	55mm	110mm	12mm	50mm
M10	80mm	135mm	12mm	50mm
M12	65mm	130mm	14mm	60mm
M12	85mm	150mm	14mm	60mm

**Περσίδες παραλληλόγραμμες M8057A** INOX A4

**Μήκος Πλάτος Πάχος**  
127mm 66mm 0,6mm

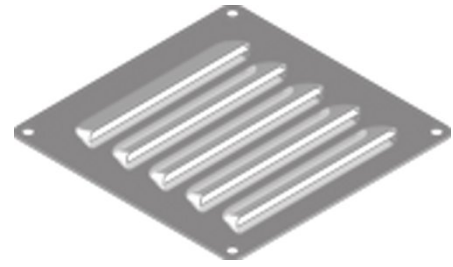
**Περσίδες τετράγωνες M8057B** INOX A4

**Μήκος Πλάτος Πάχος**  
120mm 120mm 0,6mm

**Περσίδες μακρόστενες M8057C** INOX A4

**Μήκος Πλάτος Πάχος**  
230mm 115mm 0,6mm

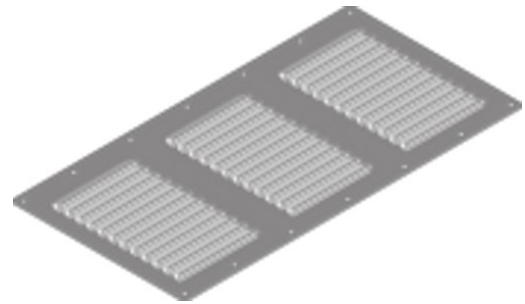
**Περσίδες μακρόστενες M8057D** INOX A4

**Μήκος Πλάτος Πάχος**  
358mm 184mm 0,6mm

**Περσίδες στρόγγυλες M8057E** INOX A4

**Διάμετρος Πάχος**  
125mm 0,6mm

**Περσίδες στρόγγυλες M8057F** INOX A4

Με κλαπέ



**Διάμετρος Πάχος**  
125mm 0,7mm

**Περσίδες παραλληλόγραμμες M8057G** INOX A4

Κάθετες



**Μήκος Πλάτος Πάχος**  
227mm 126mm 0,6mm

**Περσίδες στενές με σίτα M8057H** INOX A4

**Μήκος Πλάτος**  
212mm 57mm

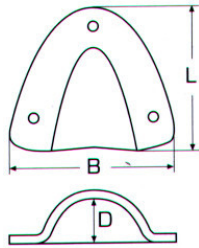
**Αεραγωγοί M8345 INOX A4**

L	B	D
57mm	55mm	16mm

**Σύρμα μαλακό σε καρούλια INOX 316I****Πάχος**

0,5mm	½kg
0,8mm	½kg
1mm	1kg
1,2mm	1kg
1,5mm	1kg
2mm	1kg

**Σίτες INOX AISI 304**

Τύπος	Πάχος
MESH3	1,00mm
MESH5	1,04mm
MESH8	0,71mm
MESH12	0,50mm
MESH16	0,45mm
MESH20	0,30mm
MESH24	0,35mm
MESH30	0,30mm
MESH40	0,19mm
MESH50	0,18mm
MESH80	0,12mm
MESH120	0,08mm

**Πλέγματα κολλητά INOX AISI 304****Τύπος**

10X10X1mm
12X12X1mm
16X16X1mm
16X16X1,5mm
20X20X1,5mm
25X25X2mm
30X30X2mm
35X35X2,5mm
40X40X3mm

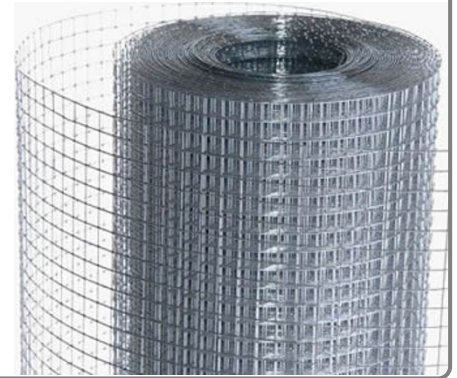

**Τάπες καταστρώματος με κλειδί M8111** INOX A4

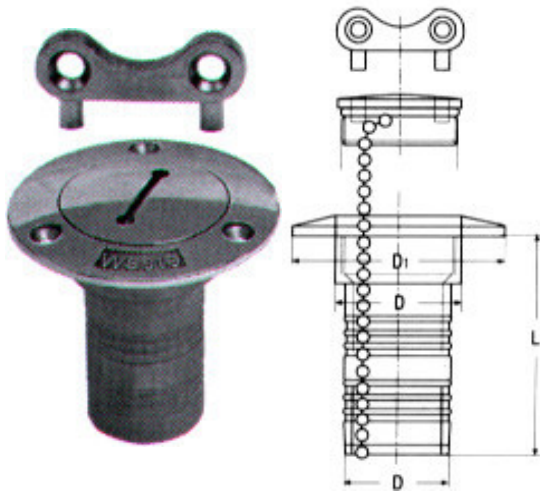

Τύπος	D	L	D1	Αλυσίδα
Αποβλήτων	38mm	78mm	75mm	✗
Πετρελαίου	38mm	78mm	75mm	✓
Πετρελαίου	51mm	79mm	87mm	✓
Νερού	38mm	78mm	75mm	✓
Νερού	51mm	79mm	87mm	✓

**Οπές κύτους ανοικτές M8351** INOX A4

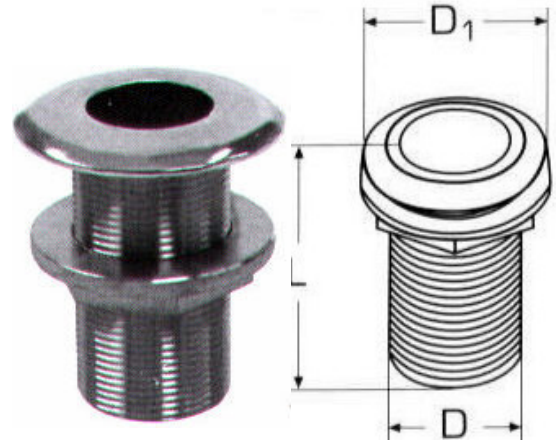

D	L	D1
1/2"	65mm	40mm
3/4"	71mm	48mm
1"	78mm	54mm
1 1/4"	84mm	70mm
1 1/2"	84mm	71mm

**Οπές κύτους με σχάρα M8452** INOX A4

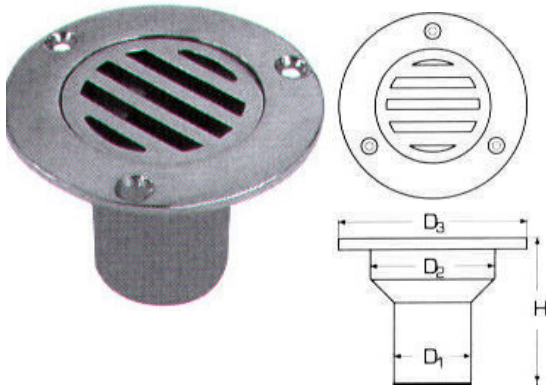

D1	D2	D3	H
37mm	58mm	82mm	60mm

**Οπές κύτους κούρμπα με σχάρα M8352** INOX A4

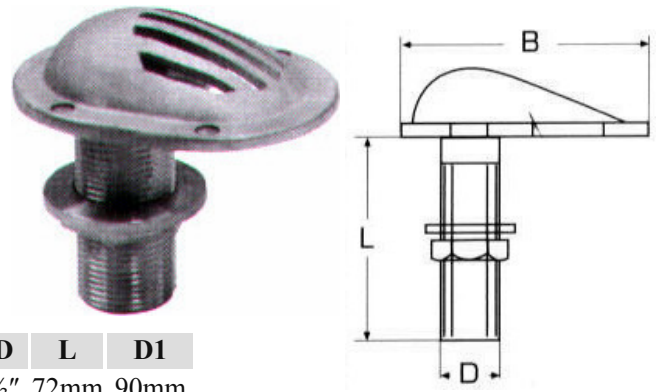

D	L	D1
1/2"	72mm	90mm
3/4"	80mm	104mm
1"	77mm	107mm
1 1/4"	79mm	118mm
1 1/2"	80mm	132mm

**Βαλβίδες εξαέρωσης M8286** INOX A4

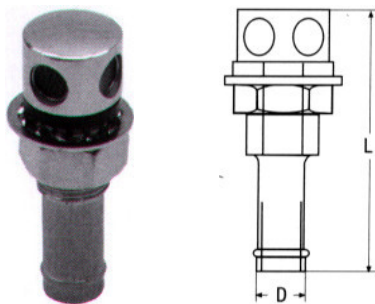

Πάσο	D	L
A M19	16mm (9/16")	75mm
B M27	25mm (1")	75mm

**Βαλβίδες εξαέρωσης M8287** INOX A4

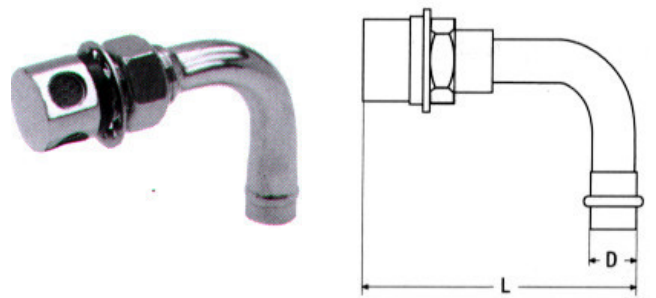

Πάσο	D	L
A M19	16mm (9/16")	88mm



**Ποτήρια σωλήνα M8270 INOX A4**



B	D1	D2	D3	E	H
22mm				58mm	
25mm				58mm	

**Στρόγγυλη χυτή βάση 82° M8283 INOX A4**

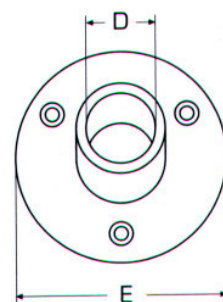
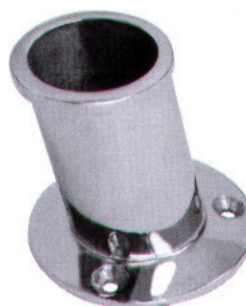

D	E	H
25mm	67mm	52mm

**Βάση κεραίας M8279 INOX A4**

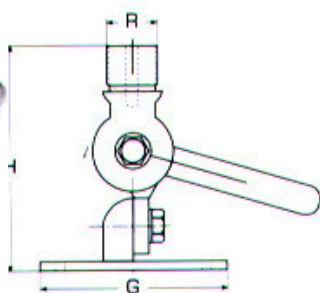

G	F	H	R
92mm	64mm	108mm	3/4"

**Βάση κεραίας 90° στρογγύλη M8201 INOX A4**

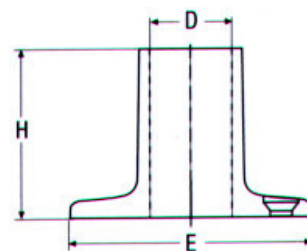
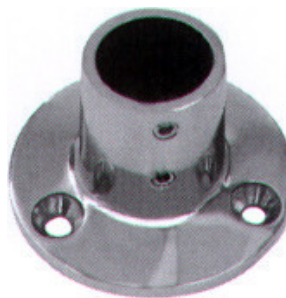

G	E	H
22mm	66mm	43mm
25mm	70mm	43mm

**Βάση κεραίας 30° στρογγύλη M8325 INOX A4**

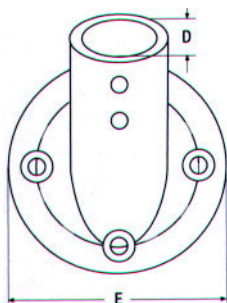
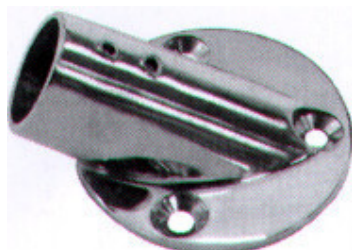

G	E	H
22mm	66mm	39mm
25mm	70mm	39mm

**Βάση κεραίας 60° στρογγύλη M8202 INOX A4**

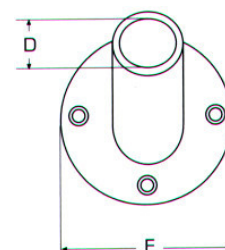
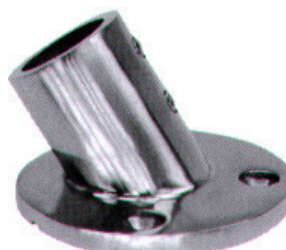

G	E	H
22mm	66mm	43mm
25mm	70mm	46mm

**Βάση κεραίας 90° με τετράφωνη βάση M8203 INOX A4**

INOX A4

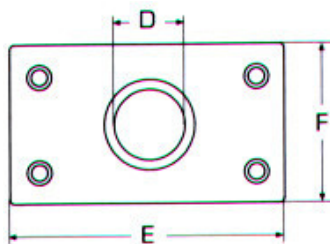
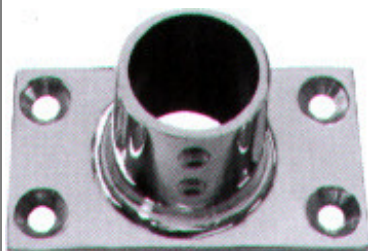

D	F	E	H
22mm	76mm	44mm	43mm
25mm	81mm	48mm	43mm

**Βάση κεραίας 60° με τετράφωνη βάση M8204 INOX A4**

INOX A4

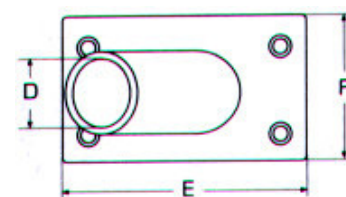
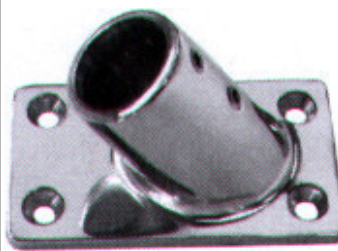

D	F	E	H
22mm	76mm	44mm	43mm
25mm	81mm	48mm	43mm

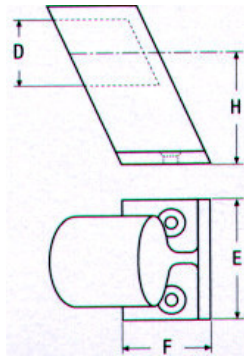
**Βάση λοξή 60° διαπερής M8207 INOX A4**

<b>G</b>	<b>H</b>	<b>F</b>	<b>E</b>
----------	----------	----------	----------

22mm	37mm	26mm	40mm
25mm	40mm	29mm	42mm

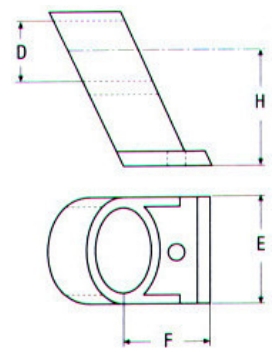
**Βάση λοξή 60° διαπερής M8209 INOX A4**

<b>D</b>	<b>H</b>	<b>F</b>	<b>E</b>
----------	----------	----------	----------

22mm	38mm	33mm	35mm
25mm	38mm	33mm	35mm

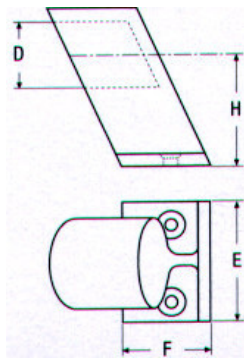
**Βάση λοξή 60° τερματική M8208 INOX A4**

<b>G</b>	<b>H</b>	<b>F</b>	<b>E</b>
----------	----------	----------	----------

22mm	37mm	26mm	40mm
25mm	40mm	29mm	42mm

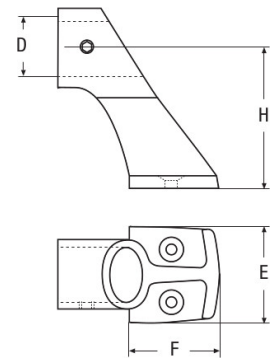
**Βάση λοξή 60° διαπερής M8276 INOX A4**

<b>D</b>	<b>H</b>	<b>F</b>	<b>E</b>
----------	----------	----------	----------

22mm	52mm	33mm	36mm
------	------	------	------

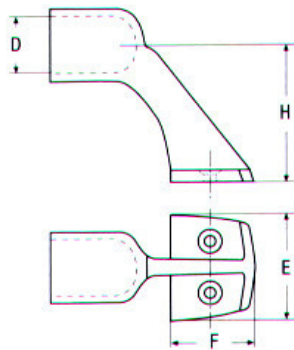
**Βάση λοξή 60° τερματική M8213 INOX A4**

<b>D</b>	<b>H</b>	<b>F</b>	<b>E</b>
----------	----------	----------	----------

22mm	52mm	33mm	36mm
------	------	------	------

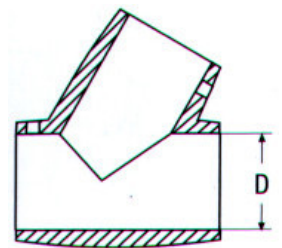
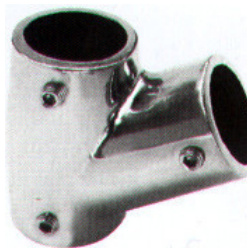
**Σύνδεσμοι T χυτοί 60° M8206 INOX A4**

<b>D</b>
----------

22mm
25mm

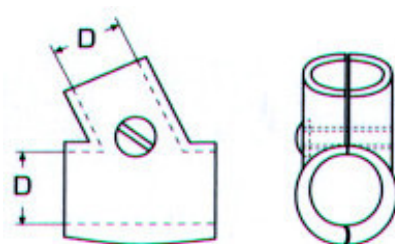
**Σύνδεσμοι T διαιρούμενοι 60° M8506 INOX A4**

<b>D</b>
----------

22mm
25mm

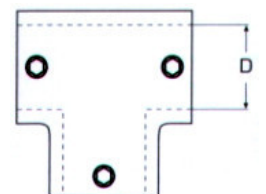
**Σύνδεσμοι T χυτοί 90° M8205 INOX A4**

<b>D</b>
----------

22mm
25mm



**Σύνδεσμοι T διαιρούμενοι 90° M8505 INOX A4**

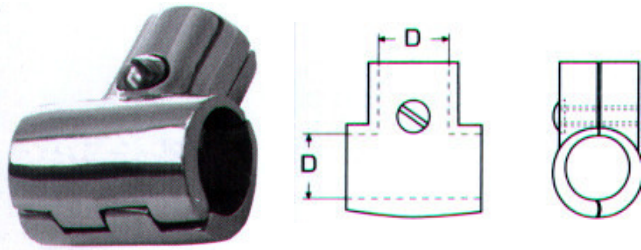

**D**  
22mm  
25mm

**Γωνίες χυτές 90° M8210 INOX A4**

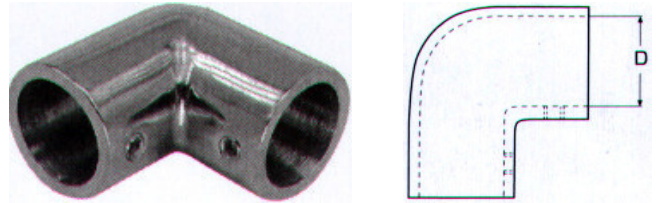

**D**  
22mm  
25mm

**Τρίστομα χυτά M8211 INOX A4**

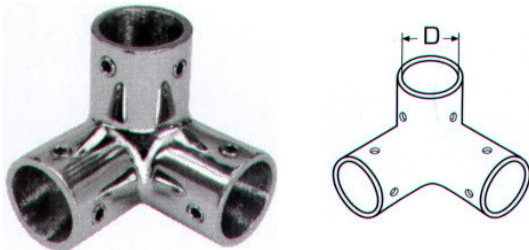

**D**  
22mm  
25mm

**Σταυροί χυτοί M8387 INOX A4**

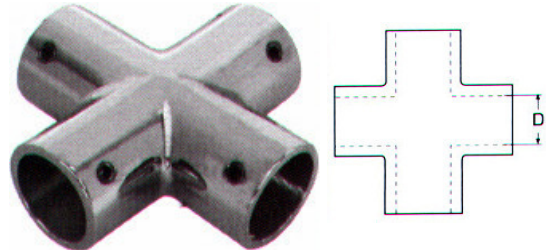

**D**  
22mm  
25mm

**Μεντεσέδες σωλήνων M8572 INOX A4**

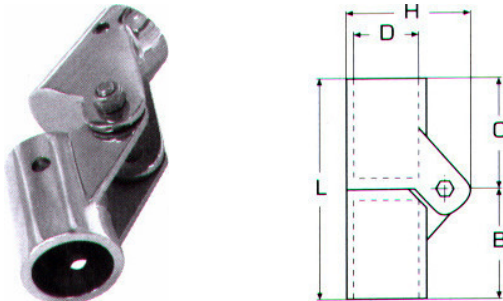

D	L	B/C	H
22mm	80mm	40mm	47mm
25mm	80mm	40mm	49mm

**Βάσεις σπαστές για ποτήρι M8573 INOX A4**

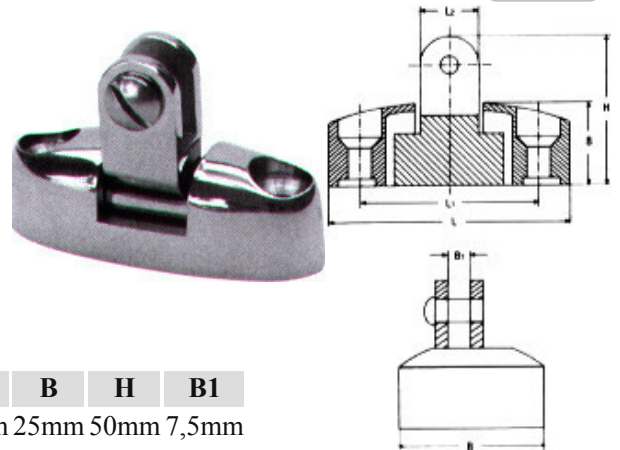

L	B	H	B1
70mm	25mm	50mm	7,5mm

**Βάσεις σωλήνα σκάλας M8134 INOX A4**

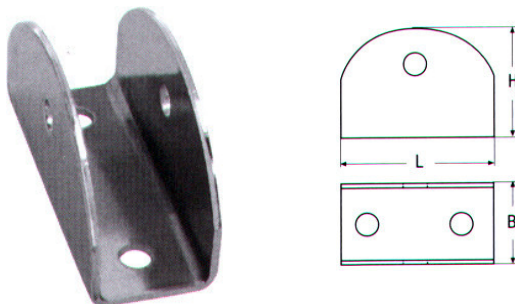

D	B	L
48mm	28mm	34mm

**Ταυ σωλήνος με κούρμα M8148 INOX A4**

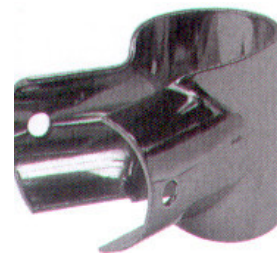

D	Γωνία	L
22mm	90°	52mm
25mm	90°	52mm
25mm	60°	52mm

**Ταυ σωλήνων πλακέ M8138 INOX A4**

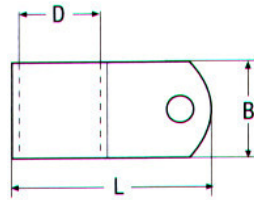
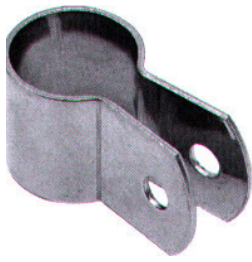

<b>D</b>	<b>B</b>	<b>L</b>
20mm	45mm	30mm

**Σφυγκτήρες σωλήνων M8135 INOX A4**

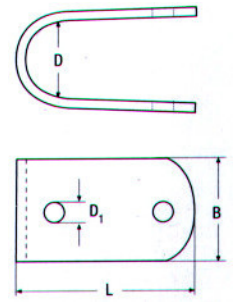
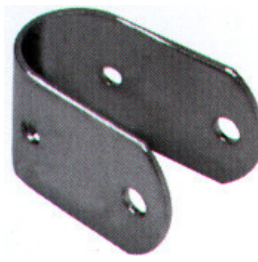

<b>L</b>	<b>B</b>	<b>D</b>	<b>D1</b>
58mm	30mm	20mm	7mm

**Σφυγκτήρες σωλήνων M8354 INOX A4**

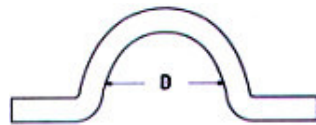

<b>Τύπος</b>	<b>D</b>
Ω	25mm
U	25mm

**Σφυγκτήρες σωλήνων ελαφρού τύπου M8460 INOX A4**

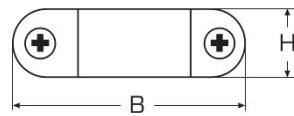
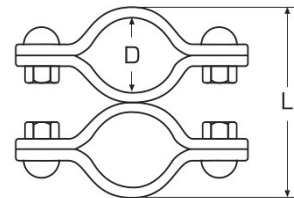

Τύπος	D	B	L	H
Περιστρεφόμενοι	25mm	62mm	55mm	20mm
Σταθεροί	25mm	60mm	55mm	20mm
Μονοί	25mm	62mm	25mm	20mm

**Σφυγκτήρες σωλήνων βαρέως τύπου M8461 INOX A4**

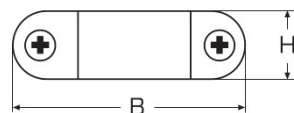
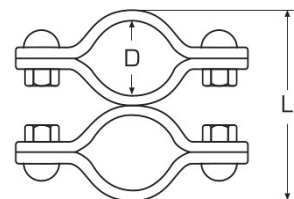

Τύπος	D	L	H
Περιστρεφόμενοι	19-30mm	65mm	55mm
Σταθεροί	19-30mm	65mm	55mm
Με απόσταση	19-30mm	65mm	72mm

**Διαμπερείς σωλήνες M8271 INOX A4**

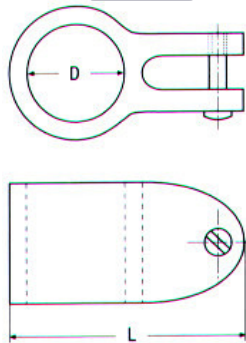

**D L**  
22mm 51mm  
25mm 59mm

**Διαμπερείς σωλήνες διαιρούμενοι M8277 INOX A4**

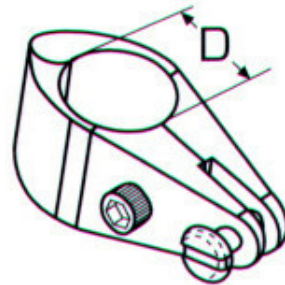
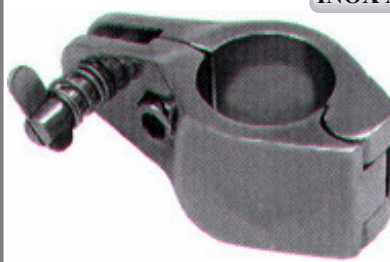

**D L**  
22mm 69mm  
25mm 69mm

**Βάσεις με πύρο και ελατήριο M8328 INOX A4**

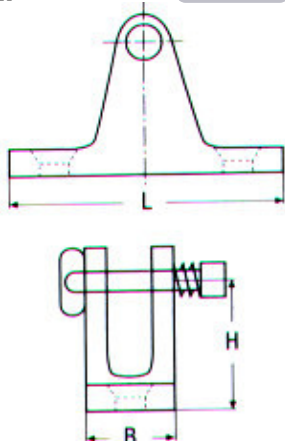
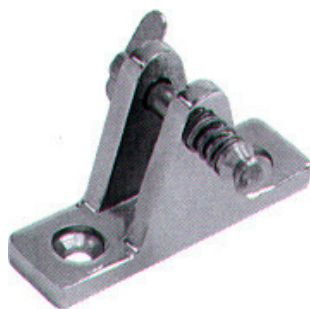

**L B H**  
60mm 18mm 29mm

**Βάσεις με βίδα M8273 INOX A4**

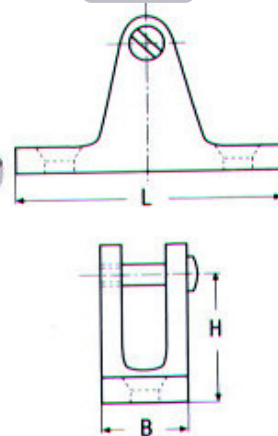

**L B H**  
60mm 18mm 29mm

**Βάσεις κούρμα με πύρο και ελατήριο M8329 INOX A4**

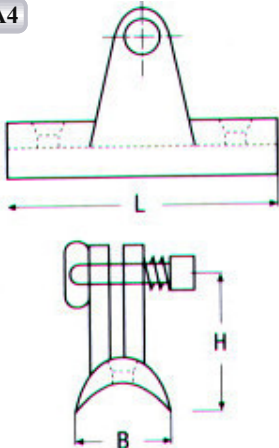
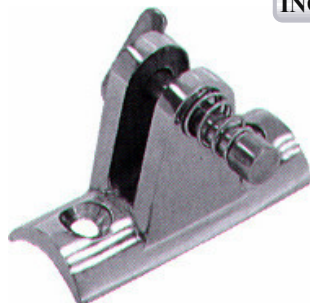

**L B H**  
60mm 22mm 29mm

**Βάσεις κούρμα με βίδα M8272 INOX A4**

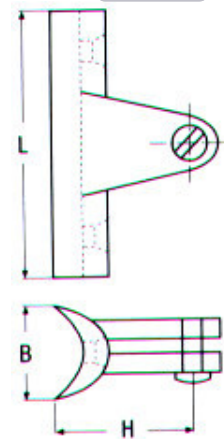
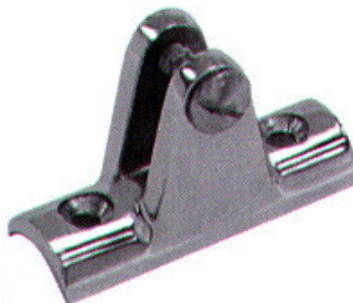

**L B H**  
60mm 22mm 29mm

**Βάσεις κάθετες με βίδα M8274 INOX A4**

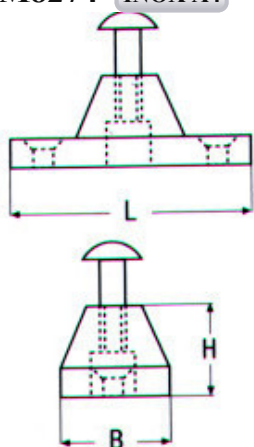

**L B H**  
50mm 23mm 19mm

**Αγκράφες M8764 INOX A4**

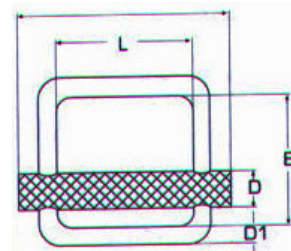

**L B D D1**  
25mm 25mm 9mm 4mm

**Γωνίες 90° MM INOX 304**



D	D
1/8"	1"
1/4"	1 1/4"
3/8"	1 1/2"
1/2"	2"
3/4"	

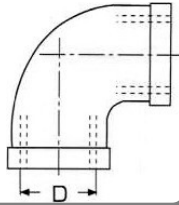

**Γωνίες 90° ΜΕ INOX 304**



D	D
1/8"	1"
1/4"	1 1/4"
3/8"	1 1/2"
1/2"	2"
3/4"	

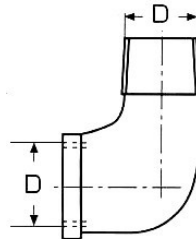

**Μούφες INOX 304**



D	D
1/8"	1"
1/4"	1 1/4"
3/8"	1 1/2"
1/2"	2"
3/4"	

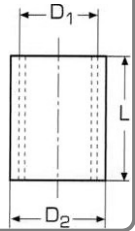

**Τάπες θηλυκές INOX 304**

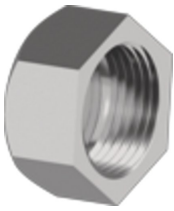

D	D
1/8"	1"
1/4"	1 1/4"
3/8"	1 1/2"
1/2"	2"
3/4"	

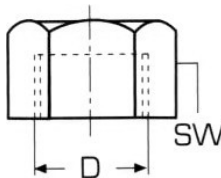

**Ρακόρ INOX 304**



D	D
1/8"	1"
1/4"	1 1/4"
3/8"	1 1/2"
1/2"	2"
3/4"	

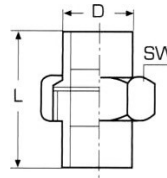

**Τάπες αρσενικές INOX 304**

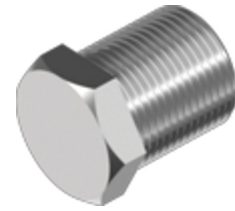

D	D
1/8"	1"
1/4"	1 1/4"
3/8"	1 1/2"
1/2"	2"
3/4"	

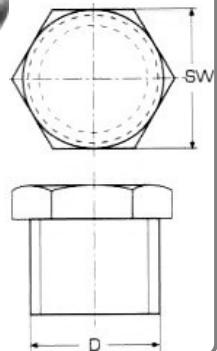

**Συστολές Αμερικής INOX 304**



Τύπος	Τύπος
1/8"X1/4"	1"X1 1/4"
1/4"X3/8"	1 1/4"X1 1/2"
3/8"X1/2"	1 1/2"X2"
1/2"X3/4"	
3/4"X1"	

**Σωληνομαστοί INOX 304**

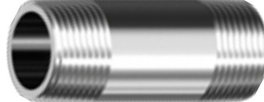

Τύπος	Τύπος
1/8"-10cm	1/2"-20cm
1/4"-5cm	3/4"-10cm
1/4"-10cm	3/4"-15cm
3/8"-5cm	3/4"-20cm
3/8"-10cm	1"-10cm
1/2"-10cm	1"-15cm
1/2"-15cm	1"-20cm

**Βάνες INOX 316**



Τύπος	Τύπος
1/4"	1"
3/8"	1 1/4"
1/2"	1 1/2"
3/4"	2"

**Νίπελ INOX 304**



D	D
1/8"	1"
1/4"	1 1/4"
3/8"	1 1/2"
1/2"	2"
3/4"	

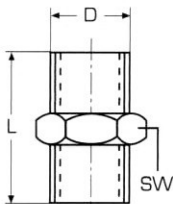

**Ακροσωλήνια INOX 304**



D	D
1/8"	1"
1/4"	1 1/4"
3/8"	1 1/2"
1/2"	2"
3/4"	

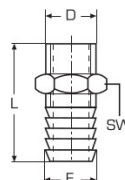

**Ταυ θηλυκά INOX 304**



D	D
1/8"	1"
1/4"	1 1/4"
3/8"	1 1/2"
1/2"	2"
3/4"	

**Παξιμάδια INOX 304**

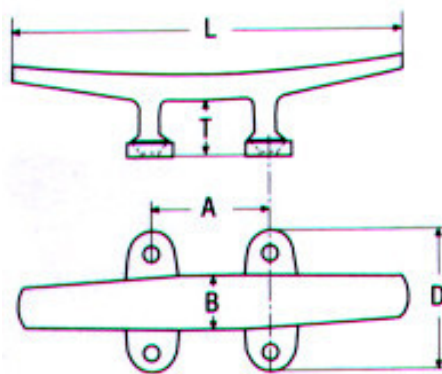
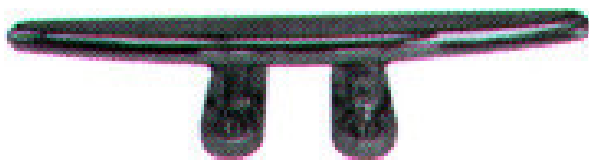

D	D
1/8"	1"
1/4"	1 1/4"
3/8"	1 1/2"
1/2"	2"
3/4"	

**Κοτσανέλα πλακέ με 4 τρύπες M8218** INOX A4

L	B	A	T	D
100mm	14mm	30mm	14mm	36mm
125mm	15mm	40mm	28mm	45mm
150mm	20mm	45mm	20mm	53mm
200mm	23mm	55mm	24mm	69mm
250mm	25mm	58mm	30mm	65mm

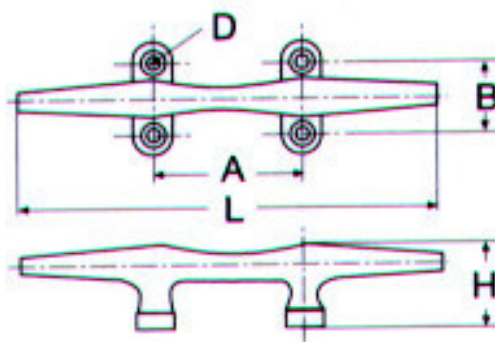
**Κοτσανέλα στρόγγυλα με 4 τρύπες M8217** INOX A4

L	B	H	D	A
125mm	25mm	28mm	5mm	54mm
150mm	26mm	32mm	6mm	56mm
200mm	34mm	39mm	6,5mm	72mm
250mm	44mm	48mm	8,5mm	94mm
300mm	49mm	53mm	8,5mm	99mm

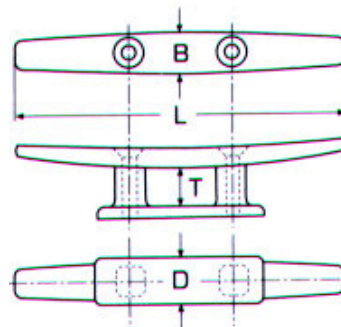
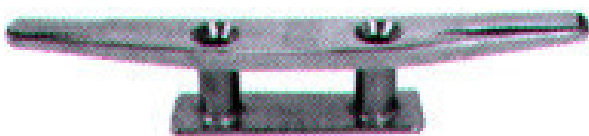
**Κοτσανέλα πλακέ με 2 τρύπες M8298** INOX A4

L	B	D	T
100mm	14mm	15mm	16mm
125mm	16mm	18mm	14mm
150mm	19mm	21mm	19mm
200mm	22mm	24mm	22mm
250mm	25mm	27mm	25mm

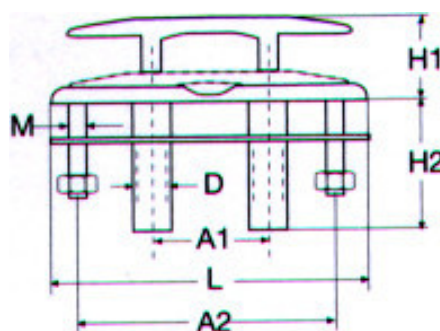
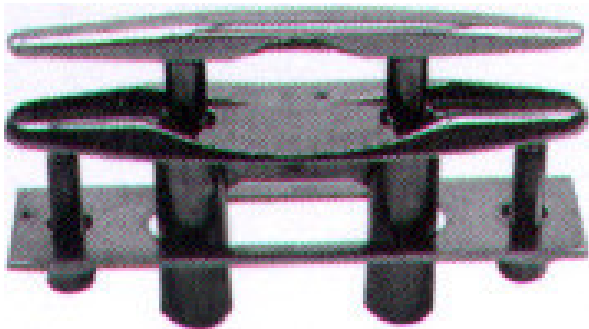
**Κοτσανέλα χωνευτά M8232** INOX A4

L	H1	H2	D	M	A1	A2
160mm	36mm	61mm	20mm	3/8"	58mm	129mm

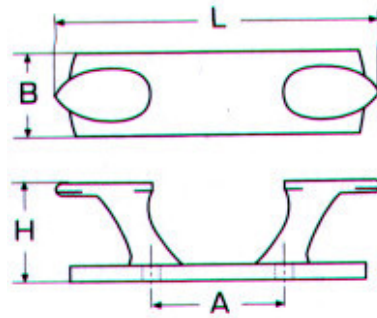
**Κοτσανέλα χυτά χωρίς τρύπες M8100 INOX A4**

L	B	H	D	A
256mm	80mm	100mm	M16	130mm

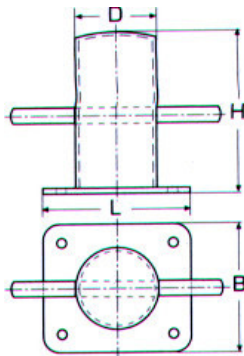
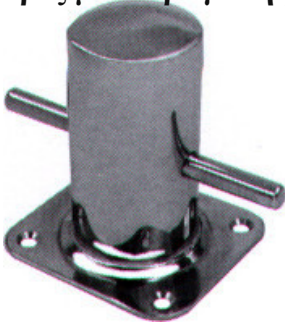
**Δέστρες με τετράγωνη βάση M8520 INOX A4**

L	B	H	D
100mm	90mm	100mm	50mm
120mm	120mm	100mm	60mm

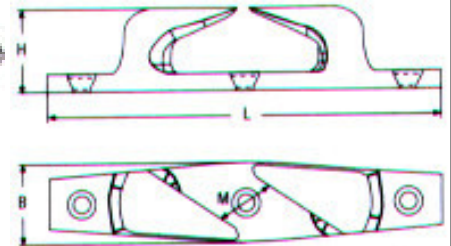
**Γλύστρες χυτές μύτη (σετ) M8219 INOX A4**

Τύπος	L	B	M	H
αριστερή	114mm	23mm	15mm	25mm
δεξιά	114mm	23mm	15mm	25mm
αριστερή	152mm	35mm	26mm	30mm
δεξιά	152mm	35mm	26mm	30mm

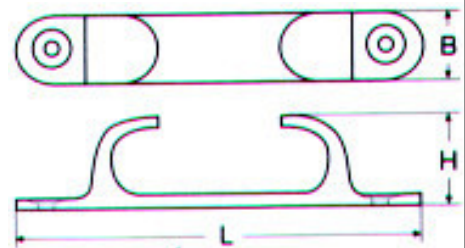
**Γλύστρες χυτές μύτη M8220 INOX A4**

L	B	H
127mm	20mm	24mm
152mm	24mm	36mm



**Δέστρες μίνι M8367** INOX A4

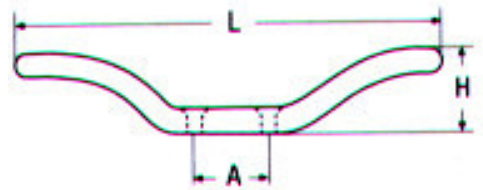

L	H	A
68mm	12mm	10mm
114mm	20mm	21mm

**Στριφτάρια άγκυρας M8304** INOX

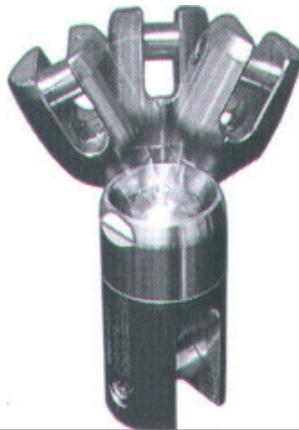

Ø Αλυσίδας	D	B	SWL	BL
6	38mm	16mm	6,00kN	24,00kN
8	45mm	21mm	10,00kN	40,00kN

**Άγκυρες M8302** INOX

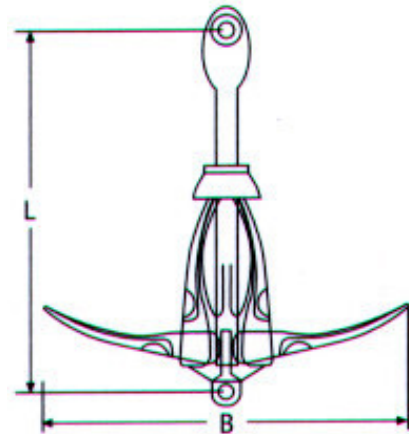

Κιλά	L	B
2,5	340mm	330mm
4	410mm	400mm
7	465mm	470mm

**Αλυσίδες με κοντό χαλκά DIN766** INOX A4

Πάχος
2mm
3mm
4mm
5mm
6mm
8mm
10mm





α|αλογιάννης ακραπερ.γρ 2310792378

